



Incisors And Cuspids 1

PSI-51-001

Tooth Ext Forceps

Fig. 1

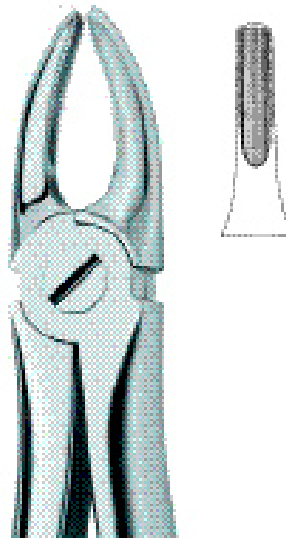

Incisors And Bicuspids 2

PSI-51-002

Tooth Ext Forceps

Fig. 2



Lower Incisors And Canines 4

PSI-004

Tooth Ext Forceps

Fig.46 L, Fig. 4

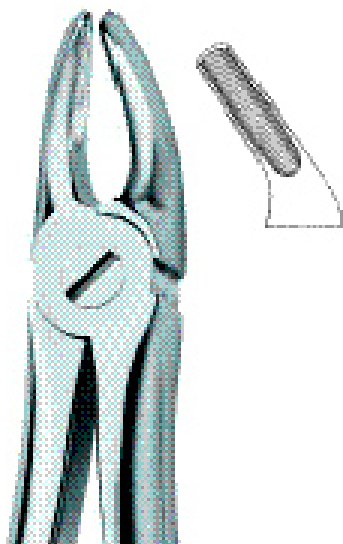

Bicuspids 7

PSI-51-007

Tooth Ext Forceps

Fig. 7



Lower Bicuspids, Universal 13

PSI-51-013

Tooth Ext Forceps

Fig. 13

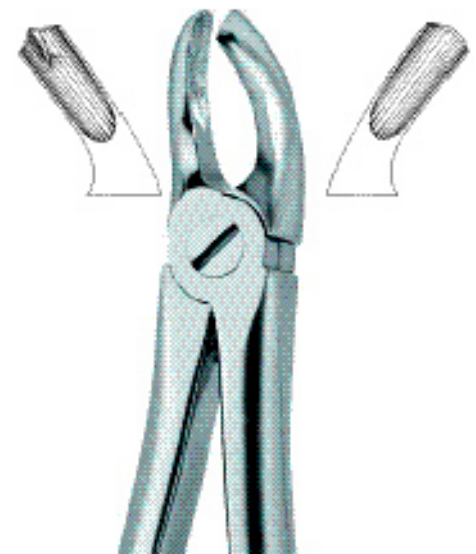

Molars, Right 17

PSI-51-017

Tooth Ext Forceps

Fig. 17

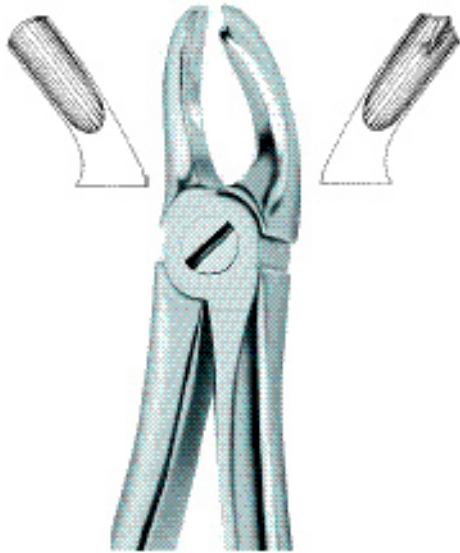

Molars, Left 18

PSI-51-018

Tooth Ext Forceps
Fig. 18

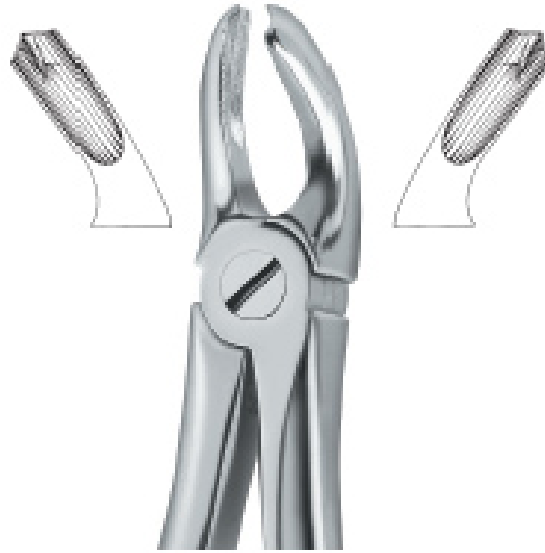

Molars 18A

PSI-51-018-01

Tooth Ext Forceps
Fig. 18A



Lower Molars , Universal 22

PSI-51-022

Tooth Ext Forceps
Fig. 22



Lower Molars, Right 23

PSI-51-023

Tooth Ext Forceps
Fig. 23



Lower Molars, Left 24

PSI-51-024

Tooth Ext Forceps
Fig. 24

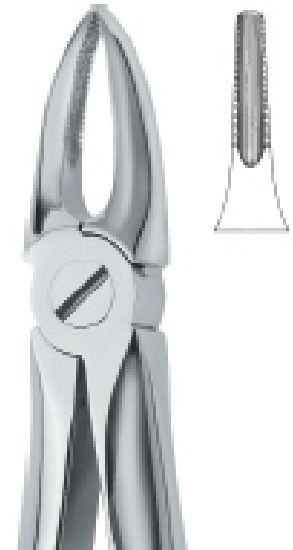

Upper Roots And Incisors 29

PSI-51-029

Tooth Ext Forceps
Fig. 29

DENTAL INSTRUMENTS

Tooth Extracting Forceps(eng)



Lower Roots 33

PSI-51-033

Tooth Ext Forceps

Fig.33



Lower Roots 01

PSI-51-033-01

Tooth Ext Forceps

Fig.33 A



Lower Roots 03

PSI-51-033-03

Tooth Ext Forceps

Fig.33 C



Lower Roots 06

PSI-51-033-06

Tooth Ext Forceps

Fig.33 M



Incisors And Bicuspid 34N

PSI-51-034

Tooth Ext Forceps

Fig.34



Incisors And Bicuspid 35N

PSI-51-035

Tooth Ext Forceps

Fig.35



Tooth Ext Forceps

PSI-51-036

Tooth Ext Forceps
Fig.36



Lower Roots 46

PSI-51-046

Tooth Ext Forceps
Fig.46



Lower Roots 46

PSI-51-046-01

Tooth Ext Forceps
Fig.46 L



Lower Roots 46

PSI-51-046-02

Tooth Ext Forceps
Fig. 14, Fig.46 LX



Very Fine Roots 49

PSI-51-049

Tooth Ext Forceps
Fig.49



Roots 51

PSI-51-051

Tooth Ext Forceps
Fig.51



Roots 51A

PSI-51-051-01

Tooth Ext Forceps
Fig.51 A



Roots 51 C

PSI-51-051-03

Tooth Ext Forceps
Fig.51 C



Tooth Ext Forceps

PSI-51-057

Tooth Ext Forceps
Fig.34 , 23.5 cm , Fig.57



Tooth Ext Forceps

PSI-51-057-1

Tooth Ext Forceps
Fig.57 A



Tooth Ext Forceps

PSI-51-057-02

Tooth Ext Forceps
Fig.57 B



Third Molars 67

PSI-51-067

Tooth Ext Forceps
Fig.46, Fig.46 LX, Fig.67



Third Molars 67 A

PSI-51-067-01

Tooth Ext Forceps
Fig.67 A



Third Molars Deep Gripping 67 N

PSI-51-067-02

Tooth Ext Forceps
Fig.67 N



Lower Molars 73

PSI-51-073

Tooth Ext Forceps
Fig.73



Lower Roots 74

PSI-51-074

Tooth Ext Forceps
Fig.74



Incisors And Roots 74N

PSI-51-074-06

Tooth Ext Forceps
Fig.74 N



Incisors And Roots ,Slender Jaw74XN

PSI-51-074-07

Tooth Ext Forceps
Fig.74 XN



Incisors And Bicuspids

PSI-51-075

Tooth Ext Forceps
Fig.75



Upper Roots 76

PSI-51-076

Tooth Ext Forceps
Fig.76



Upper Roots 76N

PSI-51-076-07

Tooth Ext Forceps
Fig.76 N



Third Molars 79

PSI-51-079

Tooth Ext Forceps
Fig.79



Third Molars 79A

PSI-51-079-01

Tooth Ext Forceps
Fig.79 A

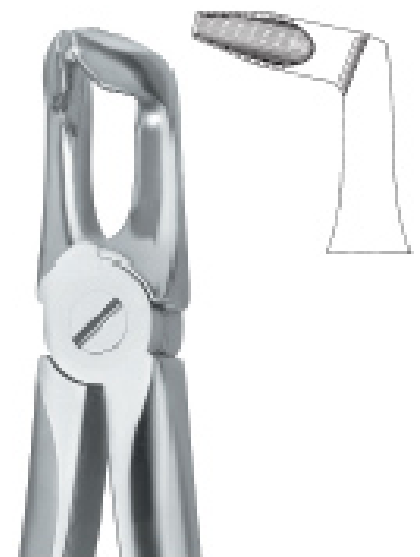

Third Molars ,Deep Gripping 79N

PSI-51-079-02

Tooth Ext Forceps
Fig.79 N



**Molars With Carious Or Broken Caps
86A**

PSI-51-086-01

Tooth Ext Forceps

Fig.233, 16 cm , 12 cm, Fig.18 L, Fig.86 A



**Molars With Carious Or Broken Caps
86B**

PSI-51-086-02

Tooth Ext Forceps

Fig.233, 16 cm , 12 cm, Fig.18 L, Fig.86 B



**Molars With Carious Or Broken Caps
86C**

PSI-51-086-03

Tooth Ext Forceps

Fig.86 C



Tooth Ext Forceps

PSI-51-097

Tooth Ext Forceps

Fig.97



Very Fine Roots 133

PSI-51-133

Tooth Ext Forceps

Fig.133



Roots Fragments, Deep Gripping 146

PSI-51-146

Tooth Ext Forceps

Fig.146



Tooth Ext Forceps

PSI-51-151

Tooth Ext Forceps
Fig.151



Tooth Ext Forceps

PSI-51-153

Tooth Ext Forceps
Fig.153



Roots, With Parallel Beak 233

PSI-51-233

Tooth Ext Forceps
Fig.233



Incisors And Bicuspid 1

PSI-51-301

Tooth Ext Forceps
Fig. 1



Incisors And Bicuspid 2

PSI-51-302

Tooth Ext Forceps
Fig. 2



Bicuspid 7

PSI-51-307

Tooth Ext Forceps
Fig. 7



Bicuspid 13

PSI-51-313

Tooth Ext Forceps

Fig. 13



Molars 17

PSI-51-317

Tooth Ext Forceps

Fig. 17



Molars 18

PSI-51-318

Tooth Ext Forceps

Fig. 18



Molars 22

PSI-51-322

Tooth Ext Forceps

Fig. 22



Roots 33

PSI-51-330

Tooth Ext Forceps

Fig.30



Roots 33

PSI-51-333

Tooth Ext Forceps

Fig.33



Roots 51

PSI-51-351

Tooth Ext Forceps
Fig.51

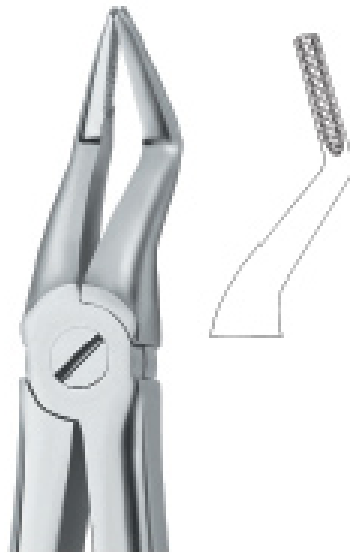

Roots, Very Fine Beak 51A

PSI-51-351-01

Tooth Ext Forceps
Fig.51 A



Third Molars 67 A

PSI-51-367-01

Tooth Ext Forceps
Fig.67 A



Molars 73

PSI-51-373

Tooth Ext Forceps
Fig.73



Incisors And Roots 74

PSI-51-374

Tooth Ext Forceps
Fig.74



**Incisors And Roots , With Fine Beak
74N**

PSI-51-374-01

Tooth Ext Forceps
Fig.74 N

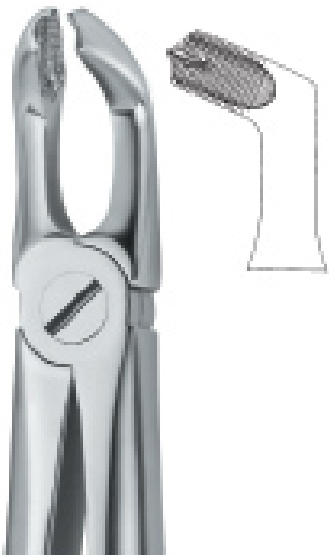

Third Molars 79

PSI-51-379

Tooth Ext Forceps
Fig.79



Incisors And Cuspids 1

PSI-51-401

Tooth Ext Forceps
Fig.1 Diam



Bicuspid 7

PSI-51-407

Tooth Ext Forceps
Fig.7 Diam



Incisors And Cuspids 13

PSI-51-413

Tooth Ext Forceps
Fig.13 Diam



Molars , Right 17

PSI-51-417

Tooth Ext Forceps
Fig.17 Diam



Molars , Left 18

PSI-51-418

Tooth Ext Forceps
Fig.18 Diam



Molars 22

PSI-51-422

Tooth Ext Forceps
Fig.22 Diam



Roots 33

PSI-51-433

Tooth Ext Forceps
Fig.33 Diam



Very Fine Roots 46

PSI-51-446

Tooth Ext Forceps
Fig.46 Diam

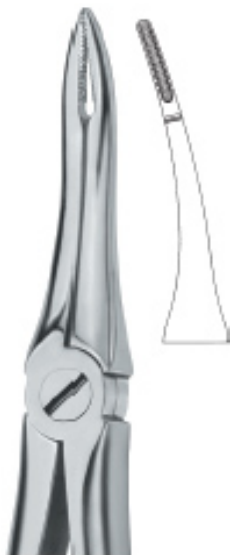

Very Fine Roots 49

PSI-51-449

Tooth Ext Forceps
Fig.49 Diam



Roots 51

PSI-51-451

Tooth Ext Forceps
Fig.51 Diam



Roots , With Fine Beak 51A

PSI-51-451-01

Tooth Ext Forceps
Fig.51 A Diam



Martin Ergo 67A

PSI-51-467-01

Tooth Ext Forceps
Fig.67 A Diam



Martin Ergo 74N

PSI-51-474

Tooth Ext Forceps
Fig.74 N Diam



Martin Ergo 79

PSI-51-479

Tooth Ext Forceps
Fig.79 Diam



Martin Ergo ,Very Fine Roots 97

PSI-51-497

Fig.97 Diam



Bicuspid 13S

PSI-51-613-09

Tooth Ext Forceps
Fig.13 S



Molars 22s

PSI-51-622-09

Tooth Ext Forceps
Fig.22 S



Incisors And Roots 30S

PSI-51-630-09

Tooth Ext Forceps



Roots 33S

PSI-51-633-09

Tooth Ext Forceps

Fig.33 S



Incisors And Bicuspid 37

PSI-51-637

Tooth Ext Forceps

Fig.37



Incisors And Cuspids 38

PSI-51-638

Tooth Ext Forceps

Fig.38



Molars 39

PSI-51-639

Tooth Ext Forceps

Fig.39



Molars 39A

PSI-51-639-01

Tooth Ext Forceps

Fig.39 A



Molars , Left 39L

PSI-51-639-05

Tooth Ext Forceps
Fig.39 L



Molars , Right 39R

PSI-51-639-08

Tooth Ext Forceps
Fig.39 R



Molars 40

PSI-51-640

Tooth Ext Forceps
Fig.40



Roots 51S

PSI-51-651-09

Tooth Ext Forceps
Fig.51 S



Roots 76S

PSI-51-676-09

Tooth Ext Forceps
Fig.76 S



Molars 3

PSI-51-703

Tooth Ext Forceps
Fig. 3



Incisors 5

PSI-51-705

Tooth Ext Forceps
Fig.5



Molars 6

PSI-51-706

Tooth Ext Forceps
Fig.6



Roots 7

PSI-51-707

Tooth Ext Forceps
Fig.7



Incisors And Cuspids 137

PSI-51-737

Tooth Ext Forceps
Fig.137



Bicuspid 139

PSI-51-739

Tooth Ext Forceps
Fig.139



Klein , Roots 51S

PSI-51-751-09

Tooth Ext Forceps
Fig.51 S

DENTAL INSTRUMENTS

Tooth Extracting Forceps(eng)



Molars 17SK

PSI-51-817-09

Tooth Ext Forceps

Fig.17 SK



Molars 23SK

PSI-51-823-09

Tooth Ext Forceps

Fig.23 SK



Teeth And Roots ,Universal 150SK

PSI-51-850-09

Tooth Ext Forceps

Fig.150 SK



Teeth And Roots ,Universal 151Sk

PSI-51-851-09

Tooth Ext Forceps

Fig.151 SK

DENTAL INSTRUMENTS

Tooth Extracting Forceps(amr)



Incisors And Bicuspid 1

PSI-52-001

Tooth Ext Forceps Amr

Fig. 1



Henahan Incisors 1A

PSI-52-001-01

Tooth Ext Forceps Amr

Fig.1 A



Molars And Third Molars 10S

PSI-52-010-09

Tooth Ext Forceps Amr

Fig.10 S



Molars 15

PSI-52-015

Tooth Ext Forceps Amr

Fig.15



Molars 16

PSI-52-016

Tooth Ext Forceps Amr

Fig.16



Molars , Slender Jaw

PSI-52-016-09

Tooth Ext Forceps Amr

Fig.16 S



Molars 17

PSI-52-017

Tooth Ext Forceps Amr
Fig. 17

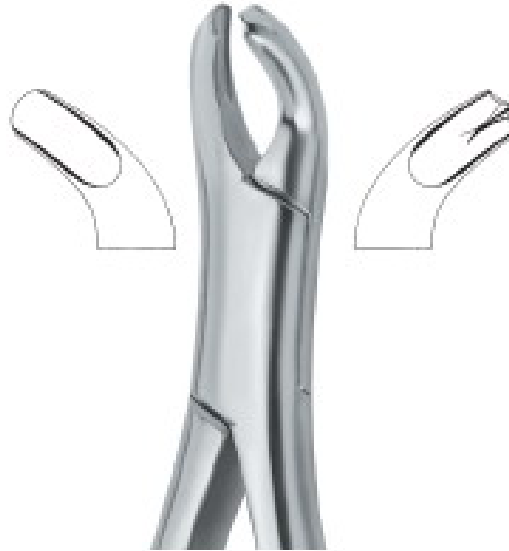

Harris Molars , Left 18L

PSI-52-018-05

Tooth Ext Forceps Amr
Fig.18 L

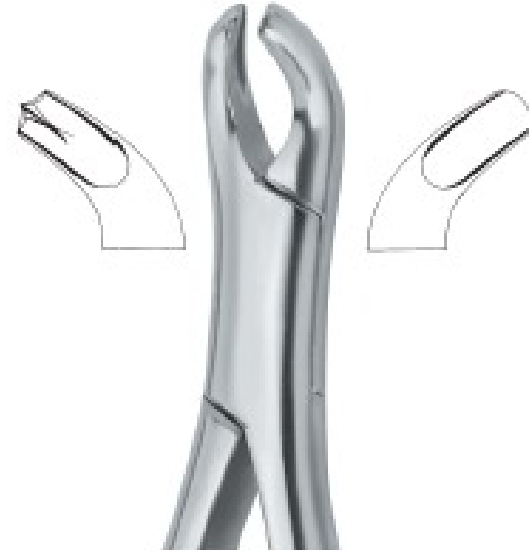

Harris Molars , Right 18R

PSI-52-018-08

Tooth Ext Forceps Amr
Fig.18 R



Molars

PSI-52-023

Tooth Ext Forceps Amr
Fig. 23



Parmlly Molars And Bicuspids 32

PSI-52-032

Tooth Ext Forceps Amr
Fig.32



**Parmlly Molars And Bicuspids , Roots
32A**

PSI-52-032-01

Tooth Ext Forceps Amr
Fig. 32 A



Molars , Left 53L

PSI-52-053-05

Tooth Ext Forceps Amr
Fig.53 L



Molars , Right 53R

PSI-52-053-08

Tooth Ext Forceps Amr
Fig.53 R



Teeth And Roots,Universal Also For Children 62

PSI-

Tooth Ext Forceps Amr
Fig.62



Incisors And Roots 65

PSI-52-065

Tooth Ext Forceps Amr
Fig.65



Tomes Roots Fragments And Small Roots 69

PSI-52-069

Tooth Ext Forceps Amr
Fig.69



Nevius Molars , Left 88L

PSI-52-088-05

Tooth Ext Forceps Amr
Fig.88 L



Nevius Molars , Right 88R

PSI-52-088-08

Tooth Ext Forceps Amr
Fig.88 R



**Cryer Bicuspid, Incisors And
Roots 150**

PSI-52-150

Tooth Ext Forceps Amr
Fig.150



**Cryer Bicuspid, Incisors And
Roots 150A**

PSI-52-150-01

Tooth Ext Forceps Amr
Fig.150 A



Bicuspid And Incisors , Roots 150X

PSI-52-150-02

Tooth Ext Forceps Amr
Fig.150 X



**Bicuspid And Incisors, Roots
150AS**

PSI-52-150-08

Tooth Ext Forceps Amr
Fig.150 AS



**Cryer Bicuspid And Incisors ,
Roots 150S**

PSI-52-150-09

Tooth Ext Forceps Amr
Fig.150 S

DENTAL INSTRUMENTS

Tooth Extracting Forceps(amr)



**Cryer Bicuspid , Incisors And Roots
151**

PSI-52-151

Tooth Ext Forceps Amr
Fig.151



**Cryer Bicuspid , Incisors And Roots
151A**

PSI-52-151-01

Tooth Ext Forceps Amr
Fig.151 A



**Cryer Bicuspid , Incisors And Roots
151X**

PSI-52-151-02

Tooth Ext Forceps Amr
Fig.151 X



Bicuspid And Incisors , Roots 151AS

PSI-52-151-08

Tooth Ext Forceps Amr
Fig.151 AS



**Cryer Teeth And Roots , Universal
151S**

PSI-52-151-09

Tooth Ext Forceps Amr
Fig.151 S



Third Molars 222

PSI-52-222

Tooth Ext Forceps Amr
Fig.222



Root Fragments And Universal 501

PSI-52-501

Tooth Ext Forceps Amr

Fig.501



Witzel Root Fragments And Universal 502

PSI-52-502

Tooth Ext Forceps Amr

Fig.502



Seldin 1L

PSI-53-001-05

Root Elevators

Fig.1L



Seldin 1R

PSI-53-001-08

Root Elevator

Fig.1R



Seldin 2

PSI-53-002-00

Root Elevators

Fig. 2

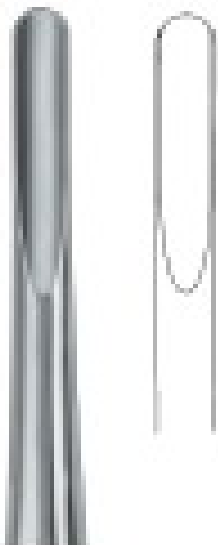

Seldin

PSI-53-003-00

Root Elevators

Fig. 3

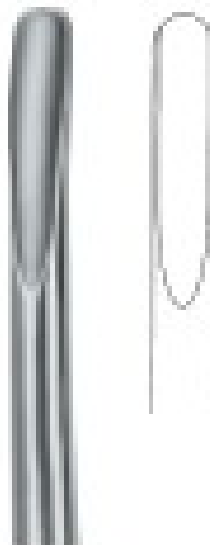

Cryer

PSI-53-003-01

Root Elevators

Fig.3 A



Seldin 4L

PSI-53-004-05

Root Elevators

Fig. 4 L



Seldin 4R

PSI-53-004-08

Root Elevators

Fig. 4 R



Crane Pick 6

PSI-53-006-00

Root Elevators

Fig. 6



Miller 1

PSI-53-008-00

Root Elevators

Fig. 8



Miller 2

PSI-53-009-00

Root Elevators

Fig. 9



Miller-Apexo

PSI-53-010-00

Root Elevators

Fig. 10



Miller-Apexo

PSI-53-011-00

Root Elevators

Fig. 11



Cryer
PSI-53-012-00
Root Elevators
Fig. 12



Cryer
PSI-53-027-00
Root Elevators
Fig.27



Cryer 28
PSI-028-00
Root Elevators
Fig.28



Seldin 34
PSI-53-034-00
Root Elevators
Fig.34

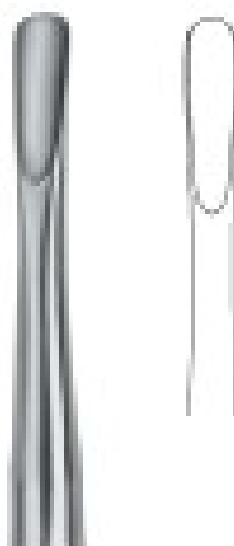

Seldin 34S
PSI-53-034-09
Root Elevators



Cryer 27S
PSI-53-039-00
Root Elevators
Fig.39



Cryer 28S

PSI-53-040-00

Root Elevators

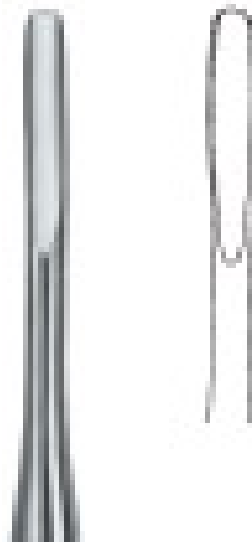

Flohr

PSI-53-046-00

Root Elevators



Barry 50

PSI-53-050-00

Root Elevators



Barry 51

PSI-53-051-00

Root Elevators



Lindo Levian 1

PSI-53-200-01

Root Elevators

Fig- 1

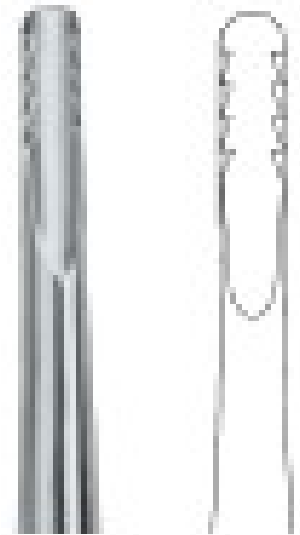

Lindo Levian 3

PSI-53-200-03

Fig. 3



Howard-Apexo # 1

PSI-53-204-00

Root Elevators

Fig. 1



Root Elevators

PSI-53-204-01

Root Elevators

Fig. 1

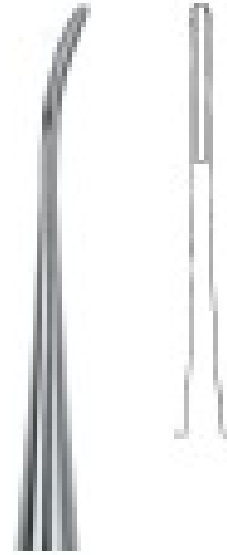

Root Elevators

PSI-53-205-00

Fig. 1

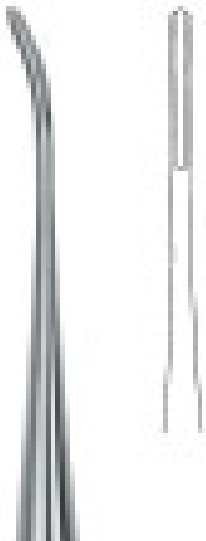

Root Elevators

PSI-53-205-01

Root Elevators

Fig. 1



Bein 1

PSI-53-220-01

Root Elevator

Fig. 2

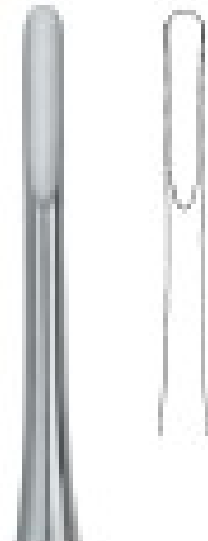

Bein 2

PSI-53-220-02

Root Elevator

Fig. 3

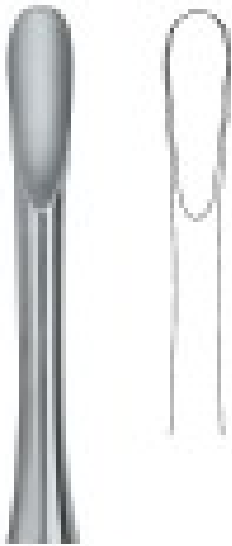

Bein 4
PSI-53-220-04

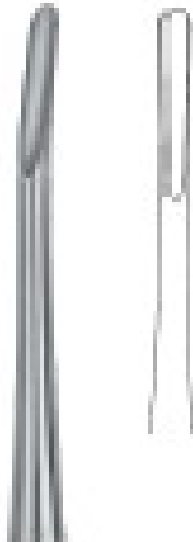

Bein 1A
PSI-53-221-01

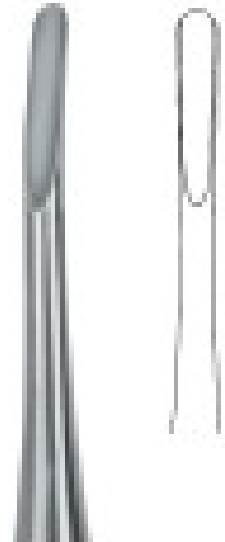

Bein 2A
PSI-53-221-02

Fig. 4

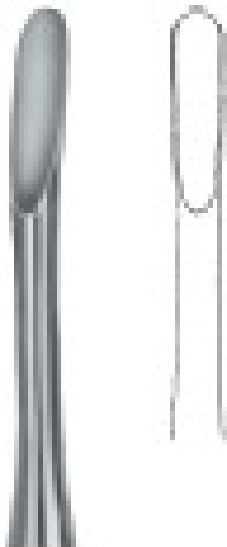

Bein 3A
PSI-53-221-03

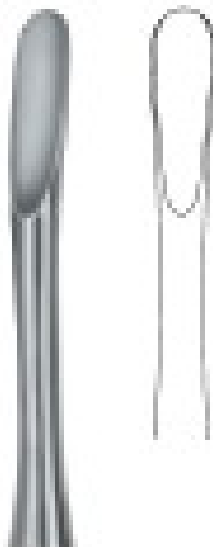

Bein 4A
PSI-53-221-04



Apical 1
PSI-53-222-01

Fig. 1

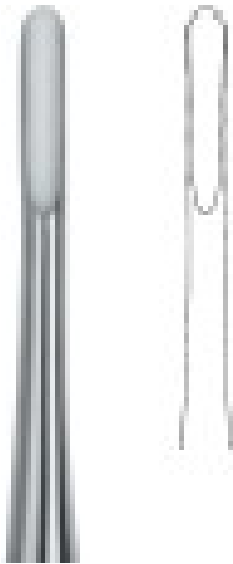

Apical 2
PSI-53-222-02

Fig. 2

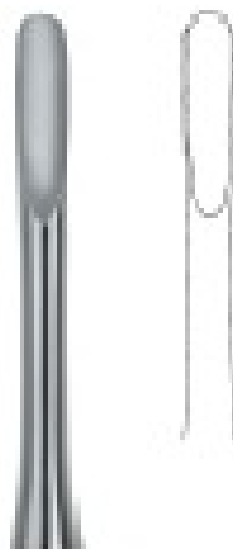

Apical 3
PSI-53-222-03

Fig. 3



Apical 4
PSI-53-222-04

Fig. 4

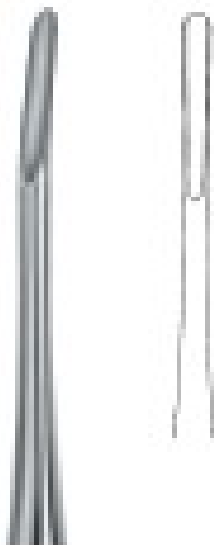

Apical 1A
PSI-53-223-01

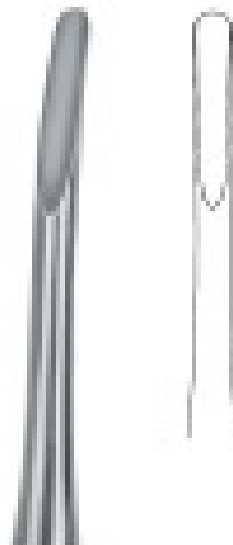

Apical 2A
PSI-53-223-02

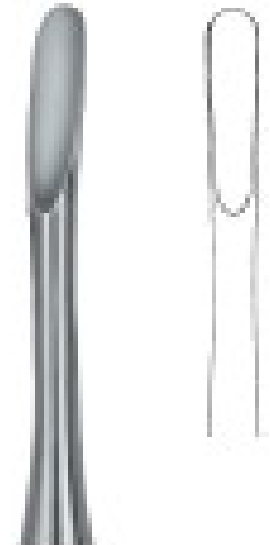

Apical 3A
PSI-53-223-03

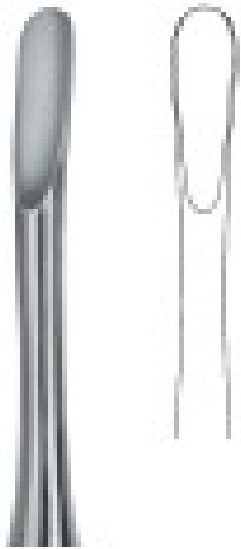

Apical 4A
PSI-53-223-04



Apical 301
PSI-53-301-00



Apical 302
PSI-53-302-00
Root Elevators



Apical-Flohr
PSI-53-303-00
Root Elevators

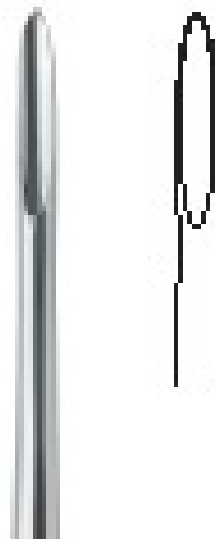

Apical 304
PSI-53-304-00
Root Elevators



Apical 46R
PSI-53-311-00
Root Elevators



Coleman
PSI-53-405-01
Root Elevators
Fig. 1



Coleman 2L
PSI-53-405-02
Root Elevators
Fig- 2L



Coleman 3R
PSI-53-405-03
Root Elevators

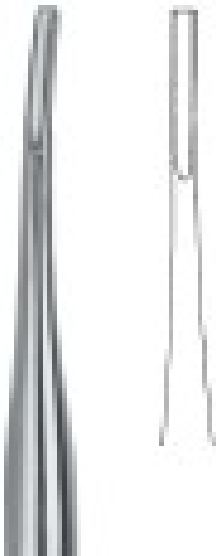

Coupland Bone Chisels 1
PSI-53-415-01
Root Elevators
Fig. 1

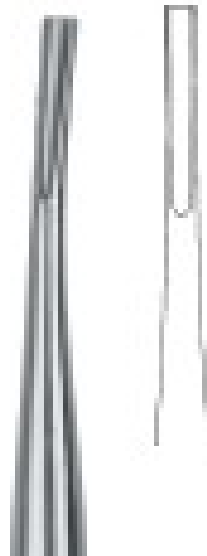

Coupland Bone Chisels 2
PSI-53-415-02
Root Elevators
Fig. 2

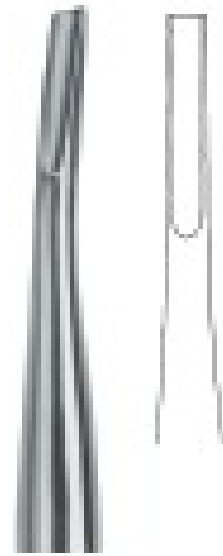

Coupland Bone Chisels 3
PSI-53-415-03
Root Elevators
Fig. 3



Friedman 1

PSI-53-505-01

Root Elevators

Fig. 1



Friedman 2L

PSI-53-505-02

Root Elevators

Fig- 2L



Friedman 2R

PSI-53-505-03

Root Elevators



Hylin 1

PSI-53-508-01

Root Elevators

Fig. 1

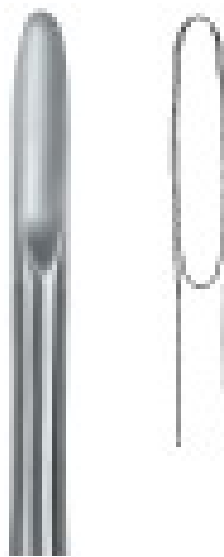

Hylin 2

PSI-53-508-02

Root Elevators

Fig. 2



Hylin 3L

PSI-53-508-03

Root Elevators



Hylin 4R

PSI-53-508-04

Root Elevators

Fig. 4 R



Bein 0

PSI-53-511-00

Root Elevators

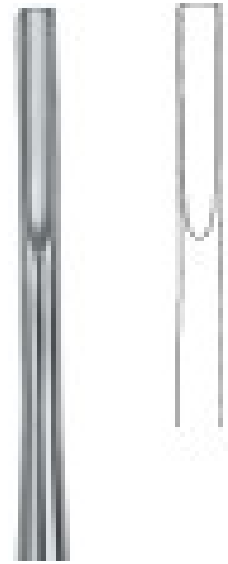

Bein 1

PSI-53-511-01

Root Elevators

Fig. 1

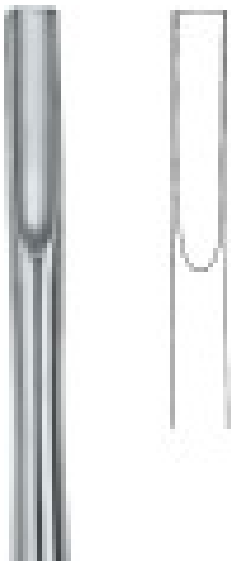

Bein 2

PSI-53-511-02

Root Elevators

Fig. 2



Bein

PSI-53-512-00

Root Elevators

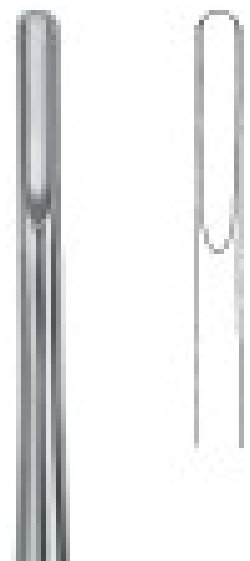

Bein 1

PSI-53-512-01

Root Elevators

Fig. 1

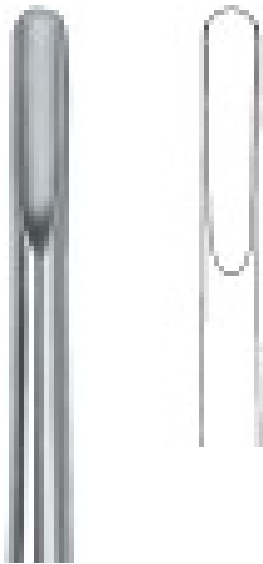

Bein 2
PSI-53-512-02
Root Elevators
Fig. 2



Bein 0
PSI-53-513-00
Root Elevators

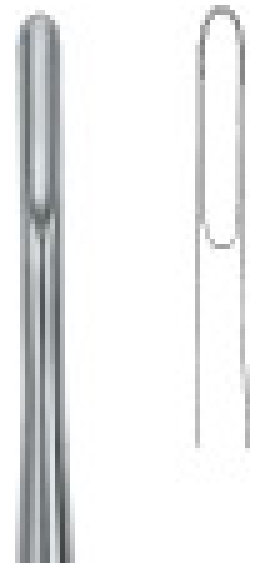

Bein 1
PSI-53-513-01
Root Elevators
Fig. 1

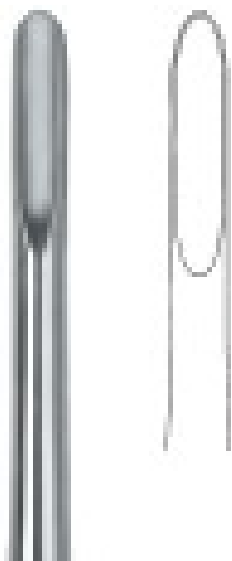

Bein 2
PSI-53-513-02
Root Elevators
Fig. 2



Bein 0A
PSI-53-514-00
Root Elevators

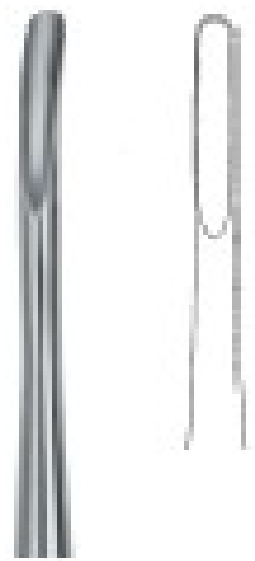

Bein 1A
PSI-53-514-01
Root Elevators

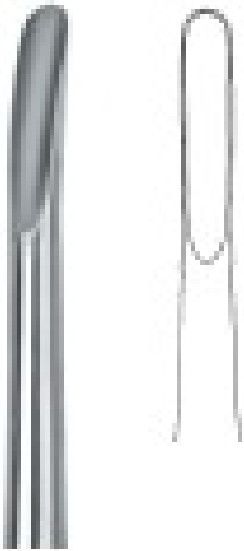

Bein 2A

PSI-53-514-02

Root Elevators



Bein 0A

PSI-53-515-00

Root Elevators

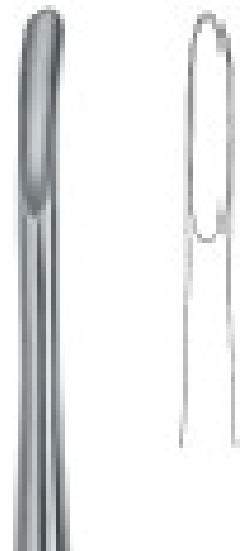

Bein 1A

PSI-53-515-01

Root Elevators

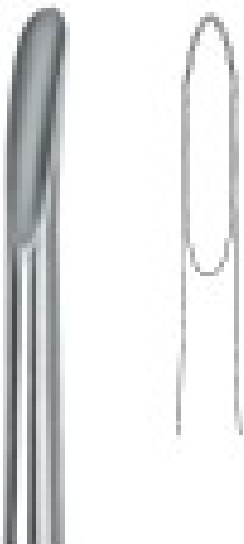

Bein 2A

PSI-53-515-02

Root Elevators



W.F. Barry 320L

PSI-53-533-20

Root Elevators



W.F. Barry 321R

PSI-53-533-21

Root Elevators



Barry 322

PSI-53-533-22

Root Elevators



Barry 323

PSI-53-533-23

Root Elevators



W.F. Barry 370R

PSI-53-533-70

Root Elevators



W.F. Barry 371R

PSI-53-533-71

Root Elevators



Winter 11L

PSI-53-551-05

Root Elevators



Winter 11R

PSI-53-551-08

Root Elevators



Winter 13L
PSI-53-553-05
Root Elevators



Winter 13R
PSI-53-553-08
Root Elevators



Winter 14L
PSI-53-554-05
Root Elevators



Winter 14R
PSI-53-554-08
Root Elevators



Lecluse 1
PSI-53-561-01
Root Elevators
Fig. 1



Pott 1
PSI-53-567-01
Root Elevators
Fig. 1



Pott 2

PSI-53-567-02

Root Elevators

Fig. 2



Krallenheber 1L

PSI-53-571-01

Root Elevators



Krallenheber 2R

PSI-53-571-02

Root Elevators



Warwick-James 1

PSI-53-576-01

Root Elevators

Fig. 1



Warwick-James 2L

PSI-53-576-02

Root Elevators



Warwick-James 3R

PSI-53-576-03

Root Elevators

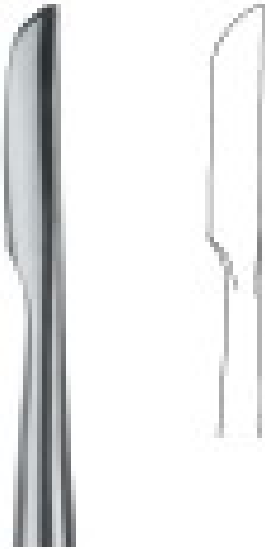

Chompret 1

PSI-53-577-01

Root Elevators

Fig. 1



Chompret 2

PSI-53-577-02

Root Elevators

Fig. 2



Chompret 3

PSI-53-577-03

Root Elevators

Fig. 3



Heidebrink 1

PSI-53-582-01

Root Elevators

Fig. 1



Heidebrink 2

PSI-53-582-02

Root Elevators

Fig. 2

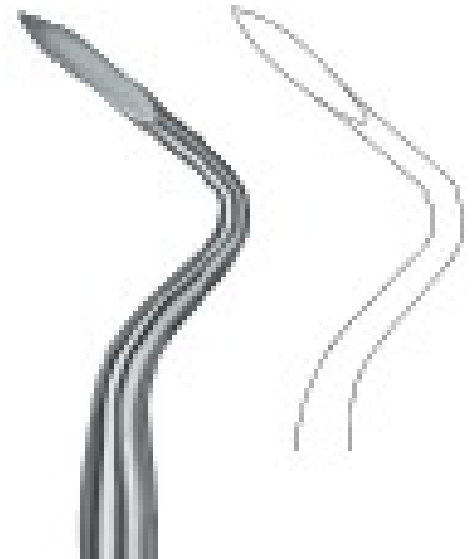

Heidebrink 3

PSI-53-582-03

Root Elevators

Fig. 3



West 1

PSI-53-584-01

Root Elevators

Fig. 1



West 2

PSI-53-584-02

Root Elevators

Fig. 2

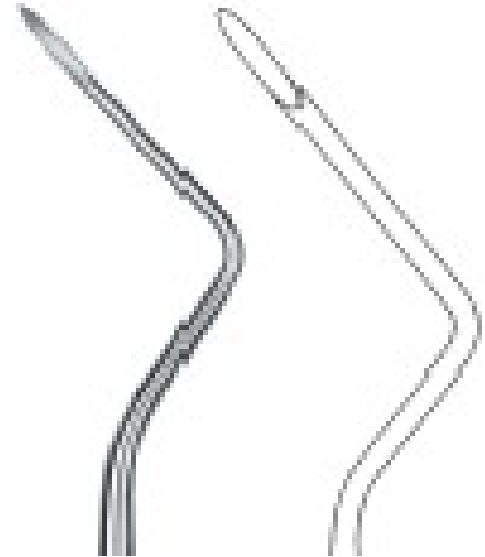

West 3

PSI-53-584-03

Root Elevators

Fig. 3



Bone Rongeur

PSI-54-101

Bone Holding Forceps
185 mm, 7"



Bone Rongeur

PSI-54-102

Bone Holding Forceps
185 mm, 7"



Bone Rongeur

PSI-54-103

Bone Holding Forceps
200 mm, 8"



Bone Rongeur

PSI-54-104

Bone Holding Forceps
215 mm, 8"



Bone Rongeur

PSI-54-105

Bone Rongeur
145 mm, 5"



Friedman-Micro 6"

PSI-54-106

Bone Rongeurs
150 mm, 6"



Friedman-Micro 5"

PSI-54-107

Bone Rongeurs
145 mm, 5"



Bone Rongeur

PSI-54-108

Bone Rongeur
140 mm, 5"



LUER 6"

PSI-54-109

Bone Rongeurs
150 mm, 6"



LUER 6"

PSI-54-110

Bone Rongeurs
155 mm, 6"



2A-MEAD, SQUARE TIPS 5"

PSI-54-111

Bone Rongeur
145 mm, 5"



BLUMENTHAL 6"

PSI-54-112

Bone Rongeur
Fig.233, 16 cm , 12 cm, Fig.18 L, 155 mm, 6"



BLUMENTHAL 45° 6"

PSI-54-113

Bone Rongeur
150 mm, 6"



Bone Rongeur 7"

PSI-54-114

Bone Rongeur
Fig.233, 16 cm , 12 cm, Fig.18 L, 7"



Bone Rongeur

PSI-54-115

Bone Rongeur
Fig.233, 16 cm , 12 cm, Fig.18 L, 0 - 83x14, 6"



BEYER 7"

PSI-54-116

Bone Rongeur
7"



MEAD 6½"

PSI-54-117

Bone Rongeur



BANE-HEARTMANN 7"

PSI-54-118

Bone Rongeur
7"



BEYER DOUBLE-ACTION 7"

PSI-54-119

Bone Rongeur

7"



ZUFAL-JANSEN 7"

PSI-54-120

Bone Rongeur

7"



Bone Rongeur

PSI-54-121

Bone Rongeur



Bone Rongeur

PSI-54-122

Bone Rongeur



Cleveland 5"

PSI-54-123

Bone Cutting Forceps

5"



Bone Rongeur

PSI-54-124

Bone Cutting Forceps

150 mm, 6"



Fig. 1
Polokoff

Polokoff

PSI-55-101

Bone Files

Fig. 1

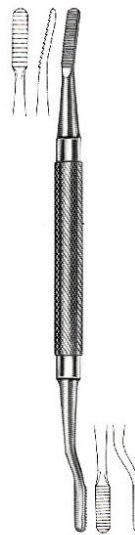

Fig. 33

Bone Files

PSI-55-102

Bone Files

Fig. 33



Fig. 64
Miler

Miler

PSI-55-103

Bone Files



Fig. 45
Miler

Miler

PSI-55-104

Bone Files



Fig. 10

Bone Files

PSI-55-105

Bone Files



Fig. 1
Wahl

Wahl

PSI-55-106

Bone Files

Fig. 1



Fig. 2
Wahl

Wahl
PSI-55-107
Bone Files
Fig. 2



Fig. 12CA

Bone Files
PSI-55-108
Bone Files



Fig. 12A

Bone Files
PSI-55-109
Bone Files

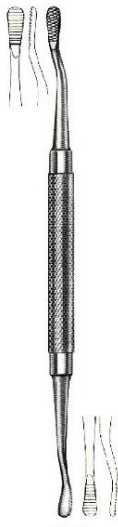

Fig. 12
Howard

Howard
PSI-55-110
Bone Files



Fig. 1
Hemingway

Hemingway

PSI-56-101

Bone Curettes

Fig. 1



Fig. 2
Hemingway

Hemingway

PSI-56-102

Hemingway



Fig. 3
Hemingway

Hemingway

PSI-56-103

Bone Curettes



Fig. 4
Hemingway

Hemingway

PSI-56-104

Bone Curettes



Fig. 86
Lucas

Lucas

PSI-56-105

Bone Curettes



Fig. 86
Lucas

Lucas

PSI-56-106

Bone Curettes



Fig. 87
Lucas

Lucas

PSI-56-107

Bone Curettes



Fig. 88
Lucas

Lucas

PSI-56-108

Bone Curettes



Fig. 1
Hemingway

Hemingway

PSI-56-109

Bone Curettes

Fig. 1



Fig. 2
Hemingway

Hemingway

PSI-56-110

Bone Curettes



Fig. 3
Hemingway

Hemingway

PSI-56-111

Bone Curettes



Fig. 4
Hemingway

Hemingway

PSI-56-112

Bone Curettes

Fig. 4



Fig. 85
Lucas

Lucas

PSI-56-113

Bone Curettes



Fig. 86
Lucas

Lucas

PSI-56-114

Bone Curettes



Fig. 87
Lucas

Lucas

PSI-56-115

Bone Curettes



Fig. 88
Lucas

Lucas

PSI-56-116

Bone Curettes

DENTAL INSTRUMENTS

Cotton & Dressing Tweezers



Cotton & Dressing Tweezers

PSI-57-101

Tooth Tweezers



College Tweezer

PSI-57-102

Cotton & Dressing Tweezers



College Tweezer Smooth Plan Handle

PSI-57-103

Cotton & Dressing Tweezers
150 mm, 6"



Meriam Tweezers

PSI-57-104

Cotton & Dressing Tweezers
150 mm, 6"



College Tweezer

PSI-57-105

Cotton & Dressing Tweezers
6"



Meriam Tweezers

PSI-57-106

Cotton & Dressing Tweezers
6"



Meriam Tweezers

PSI-57-107

Cotton & Dressing Tweezers

6"



College Tweezer

PSI-57-108

Cotton & Dressing Tweezers

150 mm, 6"



College Tweezer

PSI-57-109

Cotton & Dressing Tweezers

150 mm, 6"



Self Locking Tweezer Serr.

PSI-57-110

Cotton & Dressing Tweezers

150 mm, 6"



College Tweezer

PSI-57-111

Cotton & Dressing Tweezers

150 mm, 6"



College Tweezer

PSI-57-112

Cotton & Dressing Tweezers

150 mm, 6"



Perry Tweezer

PSI-57-113

Cotton & Dressing Tweezers



Cotton & Dressing Tweezers

PSI-57-114

Cotton & Dressing Tweezers
150 mm, 6"



Flagg Tweezer Smooth

PSI-57-115

Cotton & Dressing Tweezers
150 mm, 6"



Flagg Tweezer Serrated

PSI-57-116

Cotton & Dressing Tweezers
150 mm, 6"



Cotton & Dressing Tweezers

PSI-57-117

Cotton & Dressing Tweezers
150 mm, 6"



Cotton & Dressing Tweezers

PSI-57-118

Tooth Tweezers
150 mm, 6"



Cotton & Dressing Tweezers

PSI-57-119

Tooth Tweezers
150 mm, 6"



Self Locking Tweezer Smooth

PSI-57-120

Cotton & Dressing Tweezers
150 mm, 6"



Suture Forceps

PSI-57-121

Cotton & Dressing Tweezers
150 mm, 6"



Rubber Dam Punch Ivory

PSI-58-101

Rubber-Dam Instruments

6"



Anisworth

PSI-58-102

Rubber-Dam Instruments

6"



Brewer

PSI-58-103

Rubber-Dam Instruments

0 - 83x14, 6"



Palmer

PSI-58-104

Rubber-Dam Instruments

7"



BIRD BEAK PLIER

PSI-59-101

ORTHODONTIC PLIERS, ANGLE



CUTTING PLIER FOR ORTHODONTICS

PSI-59-102

ORTHODONTIC PLIERS NO.1



CUTTING PLIERS FOR ORTHODONTIC

PSI-59-103

ORTHODONTIC PLIERS NO.2



DE LA ROSA ORTHO PLIER

PSI-59-104

ORTHODONTIC GROOVED PLIERS, DE LA ROSA



DE LA ROSA ORTHO PLIERS

PSI-59-105

ORTHODONTIC NON GROOVED PLIERS, DE LA
ROSA



DISTAL END CUTTER

PSI-59-106

DISTAL END CUTTER



DISTAL END CUTTER

PSI-59-107 ITC



HARD WIRE CUTTER TC

PSI-59-108 3TC



LIGHT WIRE CUTTER

PSI-59-109

MICRO-MINIATURE WIRE CUTTER



LIGHT WIRE CUTTER

PSI-59-110 ITC



**MC KELLOPS PLIERS FOR
ORTHODON**

PSI-59-111

ORTHODONTIC PLIERS, MC KELLOPS



MICRO DISTAL END CUTTER

PSI-59-112

MICRO DISTAL WIRE CUTTER



NANCE PLIERS FOR ORTHODONTICS

PSI-59-113

ORTHODONTIC PLIERS NANCE



ORTHODONTIC PLIERS

PSI-59-114

ORTHODONTIC PLIERS TO FORM LINGUAL ARCHES



ORTHODONTIC PLIER

PSI-59-115

ORTHODONTIC PLIERS TO REMOVE BRACKETS



ORTHODONTIC PLIER

PSI-59-116

ORTHODONTIC ATTACHMENT REMOVER PLIERS



ORTHODONTIC PLIERS

PSI-59-117

ORTHODONTIC ATTACHMENTS REMOVER PLIERS



ORTHODONTIC PLIERS

PSI-59-118

ORTHODONTIC DIRECT BONDING PLIERS



PLIERS FOR ORTHODONTIC CURVED

PSI-59-119

ORTHODONTIC PLIERS HOW NO.2 CURVED



PLIERS FOR ORTHODONTICS

PSI-59-120

ORTHODONTIC PLIERS



PLIERS FOR ORTHODONTICS

PSI-59-121

ORTHODONTIC PLIERS NO.2



PLIERS FOR ORTHODONTICS

PSI-59-122

ORTHODONTIC PLIERS WITH SMOOTH BEAKS



PLIERS FOR ORTHODONTICS

PSI-59-123

ORTHODONTIC PLIERS NO.2



PLIERS FOR ORTHODONTICS

PSI-59-124

ORTHODONTIC CONTOURING PLIERS, REYNOLDS



PLIERS FOR ORTHODONTICS

PSI-59-125

ORTHODONTIC PLIERS, WALDSACHS



PLIERS FOR ORTHODONTICS

PSI-59-126

ORTHODONTIC PLIERS JOHNSON



PLIERS FOR ORTHODONTICS

PSI-59-127

ORTHODONTIC PLIERS, NANCE



PLIERS FOR ORTHODONTICS

PSI-59-128

ORTHODONTIC PLIERS, YOUNG



PLIERS FOR ORTHODONTICS

PSI-59-129

ORTHODONTIC PLIERS



PLIERS FOR ORTHODONTICS

PSI-59-130

ORTHODONTIC PLIERS WITH ROUNDED JAW



PLIERS FOR ORTHODONTICS

PSI-59-131

ORTHODONTIC PLIERS, ANGLE



PLIERS FOR ORTHODONTICS

PSI-59-132

ORTHODONTIC PLIERS, ADAMS



PLIERS FOR ORTHODONTICS

PSI-59-133

ORTHODONTIC PLIERS WITH ROUND NOSE



PLIERS FOR ORTHODONTICS

PSI-59-134

ORTHODONTIC PLIERS, ADERER



PLIERS FOR ORTHODONTICS

PSI-59-135

ORTHODONTIC PLIERS ADERER



PLIERS FOR ORTHODONTICS

PSI-59-136

ORTHODONTIC PLIERS, TWEED



PLIERS FOR ORTHODONTICS

PSI-59-137

ORTHODONTIC PLIERS



PLIERS FOR ORTHODONTICS

PSI-59-138

ORTHODONTIC PLIERS, ANGLE NO.1



PLIERS FOR ORTHODONTICS STR.

PSI-59-139

ORTHODONTIC PLIERS HOW NO.1 STRAIGHT



POSTERIOR BAND REMOVER

PSI-59-140

ORTHODONTIC BAND REMOVER PLIERS



POSTERIOR BAND REMOVER

PSI-59-141

ORTHODONTIC BAND REMOVER PLIERS



UNIVERSAL PLIERS FOR ORTHODON.

PSI-59-142

UNIVERSAL ORTHODONTIC PLIERS



UNIVERSAL ORTHO PLIERS

PSI-59-143

UNIVERSAL BENDING ORTHODONTIC PLIERS



ROUND AND CONCAVE PLIERS

PSI-59-144

ORTHODONTIC PLIERS, ROUND AND CONCAVE



TWEED ORTHO PLIER

PSI-59-145

ORTHODONTIC PLIERS, TWEED



TWEED ORTHO PLIERS

PSI-59-146

ORTHODONTIC PLIERS, TWEED



TWEED ORTHO PLIERS

PSI-59-147

ORTHODONTIC LOOP FORMING PLIERS, TWEED



WEINGART ORTHO PLIERS

PSI-59-148

ORTHODONTIC UNIVERSAL PLIERS, WEINGART



WIRE CUTTER

PSI-59-151

WIRE CUTTER FOR ANY SIZE LIGATURE WIRES



WIRE CUTTER

PSI-59-152 ITC



HARD WIRE CUTTER TC

PSI-59-153-3TC



Crile-Murray

PSI-60-101

Needle Holders

5"



Mayo-Hegar

PSI-60-102

Needle Holders

145 mm, 5"



Crile-Murray

PSI-60-103

Needle Holders

150 mm, 6"



Mayo-Hegar

PSI-60-104

Needle Holders

150 mm, 6"



Mayo-Hegar

PSI-60-105

Needle Holders

7"



Mayo-Hegar

PSI-60-106

Needle Holders

200 mm, 8"



Olsen-Hegar

PSI-60-107

Needle Holders
140 mm, 5"

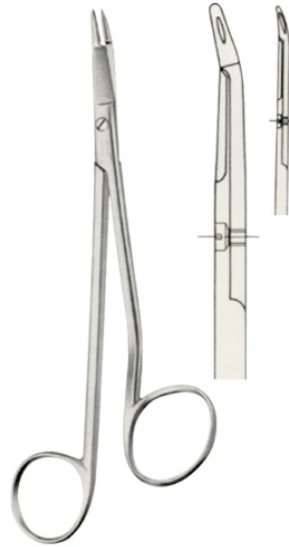

Gillies

PSI-60-108

Needle Holders
150 mm, 6"



Boynton

PSI-60-109

Needle Holders
5"



Mathieu

PSI-60-110

Needle Holders
0 - 83x14, 6"



Mathieu

PSI-60-111

Needle Holders
200 mm, 8"



Crile

PSI-60-112

Needle Holders
150 mm, 6"



Toennis
PSI-60-113
Needle Holders
7"



Mayo-Hegar
PSI-60-114
Needle Holders
6"



Mayo-Hegar
PSI-60-115
Needle Holders
8"



Mayo-Hegar
PSI-60-116
Needle Holders
6"



Mayo-Hegar
PSI-60-117
Needle Holders
8"



Debakey
PSI-60-118
Needle Holders
150 mm, 6"



Debakey

PSI-60-119

Needle Holders

7"



Ryder

PSI-60-120

Needle Holders

5"



Ryder

PSI-75-121

Needle Holders

155 mm, 6"



Ryder 7 CARB-N-SERT Jaws

PSI-60-122

Needle Holders

7



Bozemann 5

PSI-60-123

Needle Holders

5"



Olsen-Hegar CARB-N-SERT Jaws

PSI-60-124

Needle Holders

5"



Olsen-Hegar CARB-N-SERT Jaws

PSI-60-125

Needle Holders

6



Olsen-Hegar CARB-N-SERT Jaws

PSI-60-126

Needle Holders

6"



Olsen-Hegar CARB-N-SERT Jaws

PSI-60-127

Needle Holders

145 mm, 5"



Needle Holders

PSI-60-128

Needle Holders

185 mm, 7"



Needle Holders

PSI-60-129

Needle Holders

7"



Ryder 8 CARB-N-SERT Jaws

PSI-60-130

Needle Holders

200 mm, 8"



Needle Holders

PSI-60-131

Needle Holders
200 mm, 8"



Mathieu 5

PSI-60-132

Needle Holders
140 mm, 5"



Mathieu 6

PSI-60-133

Needle Holders
0 - 83x14, 5"



Mathieu 8

PSI-60-134

Needle Holders
200 mm, 8"



Mathieu 5

PSI-60-135

Needle Holders
140 mm, 5"



Mathieu 6

PSI-60-136

Needle Holders
0 - 83x14, 6"



Mathieu 8

PSI-60-137

Needle Holders
200 mm, 8"



Mathieu 7

PSI-60-138

Needle Holders
195 mm, 7"



Mathieu CARB-N-SERT Jaws

PSI-60-139

Needle Holders
205 mm, 8"

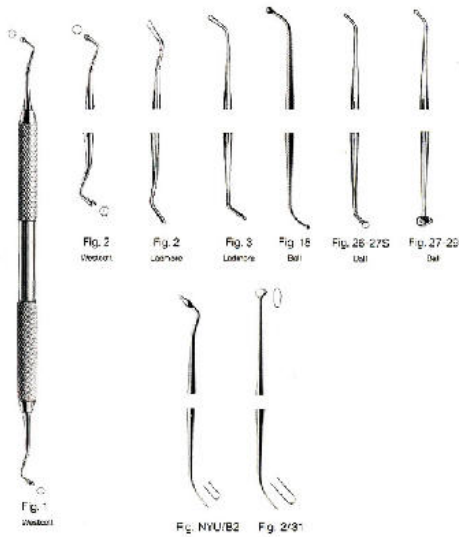

Westcott

PSI-65-101

Filling instruments

Fig. 1

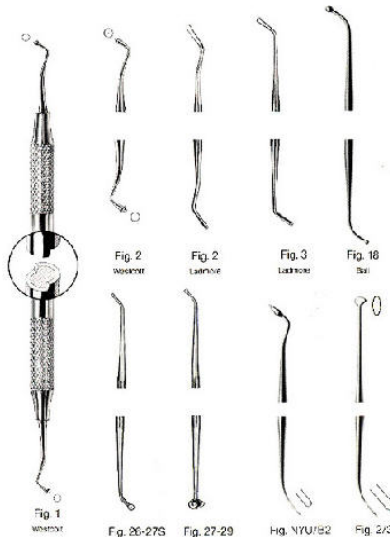

Westcott

PSI-65-110

Filling instruments

Fig. 1

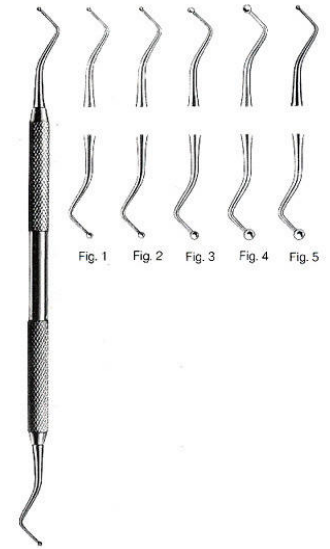

Filling Instruments

PSI-65-119

Filling instruments

Fig. 1

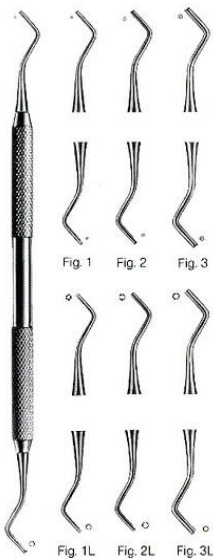

Filling Instruments

PSI-65-125

Filling instruments

Fig- 1, Fig- 1L, Fig- 2L, Fig- 3L



No. 22 Cement Spatula

PSI-66-101

No. 22 Cement Spatula



No. 24A Cement Spatula, Rigid

PSI-66-102

No. 24A Cement Spatula, Rigid



No. 24 Cement Spatula, Flexible

PSI-66-103

No. 24 Cement Spatula, Flexible



No. 313 Cement Spatula,

PSI-66-104

No. 313 Cement Spatula,



No. 5 Cement Spatula

PSI-66-105

No. 5 Cement Spatula



No. 7 Cement Spatula

PSI-66-106

No. 7 Cement Spatula

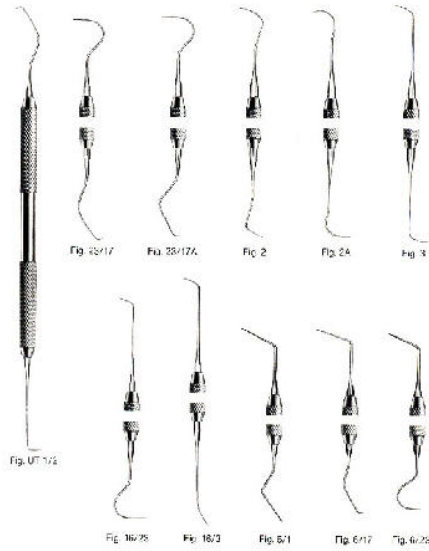

Single Ended / Double Ended Explorers

PSI-67-101

Single Ended / Double Ended Explorers
Fig- UT 1/2

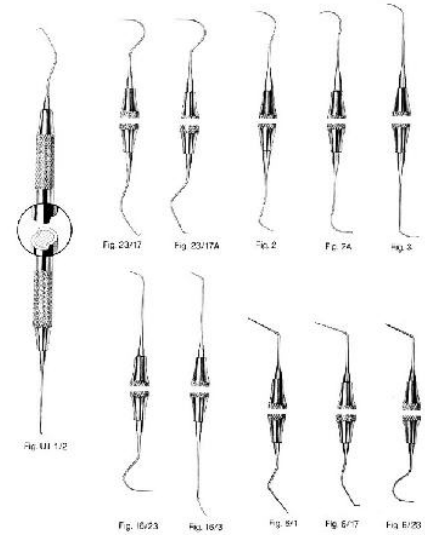

Single Ended / Double Ended Explorers

PSI-67-112

Single Ended / Double Ended Explorers
Fig- UT 1/2



Heidemann

PSI-70-101

Separating Spatulas

Fig- 1



Heidemann

PSI-70-102

Separating Spatulas



Heidemann

PSI-70-104

Separating Spatulas



Heidemann

PSI-70-105

Separating Spatulas



Heidemann

PSI-70-106

Separating Spatulas



Heidemann

PSI-70-107

Separating Spatulas



Heidemann
PSI-70-108
Separating Spatulas



Heidemann
PSI-70-109
Separating Spatulas



Heidemann
PSI-70-110
Separating Spatulas
Fig- 1



Heidemann
PSI-70-111
Separating Spatulas



Heidemann
PSI-70-112
Separating Spatulas



Fig. U15
Towner

Towner Fig U15

PSI-72-104

Scalers
Fig- U15



Fig. U15/33
Towner Jaquette

Towner Jaquette Fig- U15/33

PSI-72-105

Scalers
Fig- U15/33



Fig. U15/30
Towner Jaquette

Towner Jaquette Fig- 15/30

PSI-72-106

Scalers
Fig- 15/30



Fig H5/33

Fig- H5/33

PSI-72-107

Scalers
Fig- H5/33



Fig. H6/H7

Fig- H6/H7

PSI-72-108

Scalers
Fig- H6/H7



Fig. 1/2

Fig- 1/2

PSI-72-109

Scalers
Fig- 1/2



Fig. U15/33
Towner Jaquette

Towner Jaquette Fig- U15/33

PSI-72-110

Scalers

Fig- U15/33



Fig. J15/30
Towner Jaquette

Towner Jaquette Fig- U15/30

PSI-72-111

Scalers

Fig- U15/30

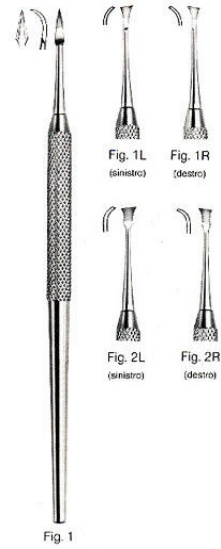

Fig. 1

Fig- 1

PSI-72-112

Scalers

Fig- 1



Scalers

PSI-72-117

Scalers

Fig- 31, Fig.32, Fig.33, Fig.34, Fig.35



Fig. H5
Hygienist

Hygienist Fig- H5

PSI-72-122

Scalers

Fig- H5



P.K. THOMAS CARVERS FIG. 1

PSI-73-101

P.K.THOMAS WAX AND MODELLING CARVERS

FIG.1



P.K. THOMAS CARVERS FIG. 2

PSI-73-102

P.K.THOMAS WAX AND MODELLING CARVERS

FIG.2



P.K. THOMAS CARVERS FIG. 3

PSI-73-103

P.K.THOMAS WAX AND MODELLING CARVERS

FIG.3



P.K. THOMAS CARVERS FIG. 4

PSI-73-104

P.K.THOMAS WAX AND MODELLING CARVERS

FIG.4



P.K. THOMAS CARVERS FIG. 5

PSI-73-105

P.K.THOMAS WAX AND MODELLING CARVERS

FIG.5



P.K.THOMAS INSTRUMENTS

PSI-73-106

P.K.THOMAS WAX AND MODELLING CARVERS

FIG.5 SILVER



P.K.THOMAS INSTRUMENTS

PSI-73-107

P.K.THOMAS WAX AND MODELLING CARVERS

FIG.4 RED



P.K.THOMAS INSTRUMENTS

PSI-73-108

P.K.THOMAS WAX AND MODELLING CARVERS

FIG.3 BLUE



P.K.THOMAS INSTRUMENTS

PSI-73-109

P.K.THOMAS WAX AND MODELLING CARVERS

FIG.2 GOLD



P.K.THOMAS INSTRUMENTS

PSI-73-110

P.K.THOMAS WAX AND MODELLING CARVERS

FIG.1 GREEN



FAHNENSTOCK Wax Carver \\\\\" Knife, 5\\\\" , Small

PSI-73-111

FAHNENSTOCK Wax Carver \\\\\" Knife, 5\\\\" , small



FAHNENSTOCK Wax Carver \\\\\" Knife, 6-3/4\\\\" , Large

PSI-73-112

FAHNENSTOCK Wax Carver \\\\\" Knife, 6-3/4\\\\" , large

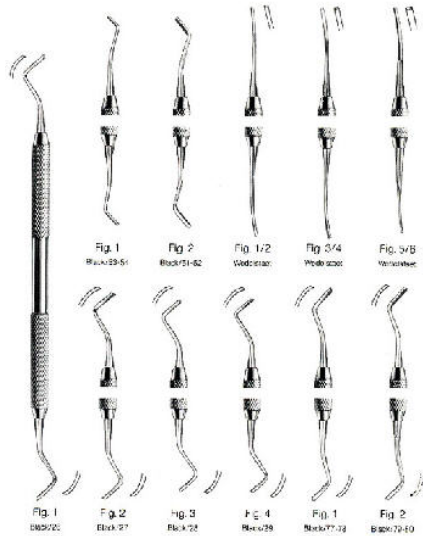

Wedeistaet

PSI-76-101

Cavity Preparation

Fig- 1, Fig- 1/2, Fig- 3/4, Fig- 5/6

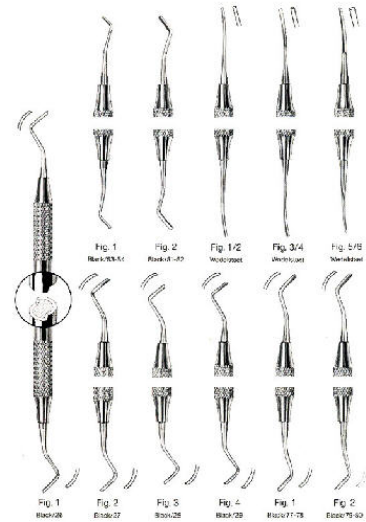

Wedeistaet

PSI-76-112

Cavity Preparation

Fig- 1, Fig- 1/2, Fig- 3/4, Fig- 5/6



A Tips For MORREL Crown Remover

PSI-78-101

A tips for MORREL Crown Remover



Tips For MORREL Crown Remover

PSI-78-102

tips for MORREL Crown Remover



C Tips For MORREL Crown Remover

PSI-78-103

C tips for MORREL Crown Remover



MORREL Crown Remover, With 3 Points

PSI-78-104

MORREL Crown Remover, with 3 points



WYMAN Carbide Crown Gripper, 5-1/2", Without Ratchet, With TC Jaws

PSI-78-105

WYMAN Carbide Crown Gripper, 5-1/2",
without ratchet, with TC jaws



X-Ray Film Hangers 6 Clips

PSI-79-101

X-RAY FILM HANGERS 6 CLIPS MADE OF STAINLESS STEEL



X-Ray Film Hangers 10 Clips

PSI-79-102

X-RAY FILM HANGERS 10 CLIPS MADE OF STAINLESS STEEL



Fig. 1
Spreader

Root Spreader Fig 1

PSI-69-101

Endodontic Instruments

Fig. 1



Fig. 2
Spreader

Root Spreader Fig 2

PSI-69-102

Endodontic Instruments



Fig. 2
Spreader

Root Spreader Fig 3

PSI-69-103

Endodontic Instruments



Fig. 4
Spreader

Root Spreader Fig 4

PSI-69-104

Endodontic Instruments



Fig. 5
Spreader

Root Spreader Fig 5

PSI-69-105

Endodontic Instruments



Fig. 6
Spreader

Root Spreader Fig 6

PSI-69-106

Endodontic Instruments



Fig. 7
Spreader

Root Spreader Fig 7

PSI-69-107

Endodontic Instruments



Fig. 1
Luks

Luks Fig 1

PSI-69-108

Endodontic Instruments

Fig- 1



Fig. 2

LUKS Fig 2

PSI-69-109

Endodontic Instruments



Fig. 3

LUKS Fig 3

PSI-69-110

Endodontic Instruments



Fig. 4

LUKS Fig 4

PSI-69-111

Endodontic Instruments



Fig. 1

Vertical Condenser Fig 1

PSI-69-112

Endodontic Instruments

Fig- 1



Fig. 2

Vertical Condenser Fig 2

PSI-69-113

Endodontic Instruments



Fig. 3

Vertical Condenser Fig 3

PSI-69-114

Endodontic Instruments



Fig. 6/1

Root Canal Explorer Fig 6/1

PSI-69-116

Endodontic Instruments

Fig- 6/1



Fig. 6/17

Root Canal Explorer Fig 6/17

PSI-69-117

Endodontic Instruments

Fig- 6/17



Fig. 6/23

Root Canal Explorer Fig 6/23

PSI-69-118

Endodontic Instruments

Fig- 6/23



Fig. 31L

Root Canal Excavators Fig 31L

PSI-69-119

Endodontic Instruments

Fig- 31L



Fig. 32L

Root Canal Excavators Fig 32L

PSI-69-120

Endodontic Instruments

Fig- 32L



Fig. 33L

Root Canal Excavators Fig 33L

PSI-69-121

Endodontic Instruments

Fig- 33L



Fig. 6/1

Root Canal Explorers Fig 6/1

PSI-69-122

Endodontic Instruments

Fig- 6/1



Fig. 6/17

Root Canal Explorers Fig 6/17

PSI-69-123

Endodontic Instruments

Fig- 6/17



Fig. 6/23

Root Canal Explorers Fig 6/23

PSI-69-124

Endodontic Instruments

Fig- 6/23



Fig. 31L

Root Canal Excavators Fig 31L

PSI-69-125

Endodontic Instruments

Fig- 31L



Fig. 32L

Root Canal Excavators Fig 32L

PSI-69-126

Endodontic Instruments

Fig- 32L



Fig. 33L

Root Canal Excavators Fig 33L

PSI-69-127

Endodontic Instruments

Fig- 33L



11 Briault D/E Explorer

PSI-77-101

FIG. # 11 BRIAULT D/E EXPLORER. MADE OF SOLID STAINLESS STEEL HANDLE



11/12 Odu D/E Explorer

PSI-77-102

FIG. # 11/12 OLD DOMINION UNIVERSITY D/E EXPLORER. MADE OF SOLID STAINLESS STEEL HANDLE



11/12 Odu D/E After Five Explorer

PSI-77-103

FIG. # 11/12 ODU D/E AFTER FIVE EXPLORER. MADE OF SOLID STAINLESS STEEL HANDLE



2A Pigtail D/E Explorer

PSI-77-104

FIG. # 2A PIGTAIL D/E EXPLORER. MADE OF SOLID STAINLESS STEEL HANDLE



2H D/E Explorer

PSI-77-105

FIG. # 2H DE EXPLORER. MADE OF SOLID STAINLESS STEEL HANDLE



2R/2L D/E Explorer

PSI-77-106

FIG. # 2R/2L D/E EXPLORER. MADE OF SOLID STAINLESS STEEL HANDLE



3 Pigtail D/E Explorer

PSI-77-107

FIG. # 3 PIGTAIL D/E EXPLORER. MADE OF SOLID STAINLESS STEEL HANDLE



3CH Cowhorn D/E Explorer

PSI-77-108

FIG. # 3CH COWHORN D/E EXPLORER. MADE OF SOLID STAINLESS STEEL HANDLE



3ES D/E Explorer

PSI-77-109

FIG. # 3ES DE EXPLORER. MADE OF SOLID STAINLESS STEEL HANDLE



5 D/E Explorer

PSI-77-110

FIG. # 5 D/E EXPLORER. MADE OF SOLID STAINLESS STEEL HANDLE



6/3 D/E Explorer

PSI-77-111

FIG. # 6/3 DE EXPLORER. MADE OF SOLID STAINLESS STEEL HANDLE



17 S/E Explorer

PSI-77-112

FIG. # 17 SE EXPLORER. MADE OF SOLID STAINLESS STEEL HANDLE



23 Shepherd's Hook Explorer

PSI-77-113

FIG. # 23 SHEPHERD'S HOOK S/E EXPLORER.
MADE OF SOLID STAINLESS STEEL HANDLE



3 S/E Explorer

PSI-77-114

FIG. # 3 SE EXPLORER. MADE OF SOLID
STAINLESS STEEL HANDLE



3A S/E Explorer

PSI-77-115

FIG. # 3A S/E EXPLORER. MADE OF SOLID
STAINLESS STEEL HANDLE



54 S/E Explorer

PSI-77-116

FIG. # 54 S/E EXPLORER. MADE OF SOLID
STAINLESS STEEL HANDLE



Impression Trays

PSI-74-101

Impression Trays



Impression Trays

PSI-74-102

Impression Trays



Impression Trays

PSI-74-103

Impression Trays



Impression Trays

PSI-74-104

Impression Trays



Impression Trays

PSI-74-105

Impression Trays



Impression Trays

PSI-74-106

Impression Trays



Impression Trays

PSI-74-107

Impression Trays



Impression Trays

PSI-74-108

Impression Trays



Impression Trays

PSI-74-109

Impression Trays



Impression Trays

PSI-74-110

Impression Trays



Impression Trays

PSI-74-111

Impression Trays



Impression Trays

PSI-74-112

Impression Trays



Impression Trays

PSI-74-113

Impression Trays



Impression Trays

PSI-74-114

Impression Trays



Impression Trays

PSI-74-115

Impression Trays



Impression Trays

PSI-74-116

Impression Trays



Impression Trays

PSI-74-117

Impression Trays



Impression Trays

PSI-74-118

Impression Trays



Impression Trays

PSI-74-119

Impression Trays



Impression Trays

PSI-74-120

Impression Trays



Impression Trays

PSI-74-121

Impression Trays



Impression Trays

PSI-74-122

Impression Trays



Impression Trays

PSI-74-123

Impression Trays



Impression Trays

PSI-74-124

Impression Trays



Impression Trays

PSI-74-125

Impression Trays

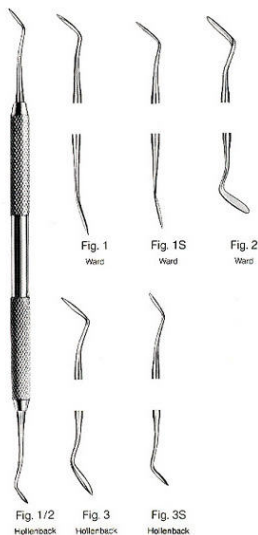

Hollenback

PSI-62-101

Amalgam Instruments

Fig- 1/2

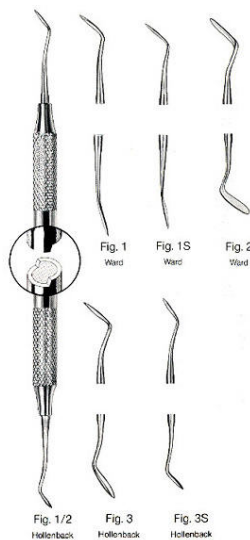

Hollenback

PSI-62-107

Amalgam Instruments

Fig- 1/2



Mortonson 1

PSI-62-113

Amalgam Instruments

Fig- 1



Fig. 2

Amalgam Instruments

PSI-62-114

Amalgam Instruments



Fig 3

Amalgam Instruments

PSI-62-115

Amalgam Instruments



Fig 4

Amalgam Instruments

PSI-62-116

Amalgam Instruments



Fig. 3-SHO

Amalgam Instruments

PSI-62-118

Amalgam Instruments



Fig. SHO-A

Amalgam Instruments

PSI-62-117

Amalgam Instruments



Fig. 104

Amalgam Instruments

PSI-62-119

Amalgam Instruments



Fig. 8

Amalgam Instruments

PSI-62-120

Amalgam Instruments



Fig. 1

Amalgam Instruments

PSI-62-121

Amalgam Instruments

Fig- 1



Fig. 2

Amalgam Instruments

PSI-62-122

Amalgam Instruments



Fig 3

Amalgam Instruments

PSI-62-123

Amalgam Instruments



Fig 4

Amalgam Instruments

PSI-62-124

Amalgam Instruments



Fig. SHO-A

Amalgam Instruments

PSI-62-125

Amalgam Instruments



Fig. 3-SHO

Amalgam Instruments

PSI-62-126

Amalgam Instruments



Fig. 104

Amalgam Instruments

PSI-62-127

Amalgam Instruments



Fig. 8

Amalgam Instruments

PSI-62-128

Amalgam Instruments



Fig. 1

Amalgam Instruments

PSI-62-129

Amalgam Instruments

Fig- 1



Fig. 2

Amalgam Instruments

PSI-62-130

Amalgam Instruments



Fig. 3

Amalgam Instruments

PSI-62-131

Amalgam Instruments



Fig. 4

Amalgam Instruments

PSI-62-132

Amalgam Instruments



Fig. 1

Amalgam Instruments

PSI-62-133

Amalgam Instruments

Fig- 1



Fig. 2

Amalgam Instruments

PSI-62-134

Amalgam Instruments



Fig. 3

Amalgam Instruments

PSI-62-135

Amalgam Instruments



Fig. 4

Amalgam Instruments

PSI-62-136

Amalgam Instruments



Toffemire-Universal

PSI-62-137

Amalgam Instruments



Amalgam Instruments

PSI-62-142

Amalgam Instruments



Amalgam Instruments

PSI-62-143

Amalgam Pistolen



Amalgam Instruments

PSI-62-144

Amalgam Pistolen
185 mm



Amalgam Instruments

PSI-62-145

Amalgam Pistolen



Amalgam Instruments

PSI-62-146

Amalgam Pistolen
145 mm



Amalgam Carrier

PSI-62-147

Amalgam Carrier
Fig- 1



Amalgam Carrier

PSI-62-148

Amalgam Carrier
Fig- 1



Amalgam Carrier

PSI-62-149

Amalgam Carrier
Fig- 1



SIMPLE STEM PLANE 4

PSI-68-113
MOUTH MIRROR



SIMPLE STEM PLANE 5

PSI-68-114
MOUTH MIRROR



SIMPLE STEM PLANE 4

PSI-68-115
MOUTH MIRROR



SIMPLE STEM PLANE 4

PSI-68-116
MOUTH MIRROR



SIMPLE STEM PLANE 4

PSI-68-117
MOUTH MIRROR



SECO / CONE-SOCKET

PSI-68-118
Mirror Handles
5"



OCTOGONAL CONE SOCKET

PSI-68-119

Mirror Handles



MARTIN ERGO

PSI-68-120

Mirror Handles

5"



Mirror Handles

PSI-68-121

Mirror Handles

5"



Mirror Handles

PSI-68-122

Mirror Handle

5"



Mirror Handles

PSI-68-123

Mirror Handles

5"



Mirror Handles

PSI-68-124

Mirror Handles

5"



Napkin Holder

PSI-68-131

Napkin Holder



Laryngeal Mirrors

PSI-68-129

MIRROR HANDLES



Cotton Wool Container

PSI-68-130

Cotton Wool Container



Laryngeal Mirrors

PSI-68-128

MIRROR HANDLES



MIRROR HANDLE CONE SOCKET

PSI-53-721-01

MIRROR HANDLES



MIRROR HANDLE CONE SOCKET

PSI-53-721-02

MIRROR HANDLE CONE SOCKET



MIRROR HANDLE CONE SOCKET

PSI-53-723-01

MIRROR HANDLES



MIRROR HANDLE

PSI-53-728-02

MIRROR HANDLES



MARTIN-GRIP

PSI-53-746-02



MIRROR HANDLE

PSI-53-755-02

MIRROR HANDLES



MIRROR HANDLE

PSI-53-757-08

MIRROR HANDLES



MIRROR

PSI-53-702-22



MIRROR
PSI-53-703-22



RHODIUM MIRROR
PSI-53-704-10
MIRROR



RHODIUM MIRROR
PSI-53-704-18
MIRROR



CONE SOCKET
PSI-53-706-22
MIRROR



CONE SOCKET
PSI-53-707-22
MIRROR



MICRO-MOUTH MIRROR
PSI-53-710-03

Fig. 1



MICRO-MOUTH MIRROR

PSI-53-710-05

Fig. 1

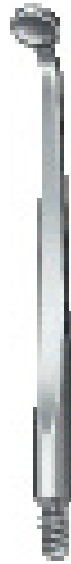

RHODIUM MICRO MIRROR

PSI-53-711-03

Fig- 1



HILGER

PSI-53-715-00



HILGER

PSI-53-715-01

CHEEK RETRACTORS



Fig. 0

Excavators Fig 0

PSI-71-101

Excavators



Fig. 1

Excavators Fig 1

PSI-71-102

Excavators

Fig- 1



Fig. 2

Excavators Fig 2

PSI-71-103

Excavators



Fig. 3

Excavators Fig 3

PSI-71-104

Excavators



Fig. 4

Excavators Fig 4

PSI-71-105

Excavators



Fig. 5

Excavators Fig 5

PSI-71-106

Excavators



Fig. 6

Excavators Fig 6

PSI-71-107

Excavators



Fig. 0

Excavators Fig 0

PSI-71-108

Excavators



Fig. 1

Excavators Fig 1

PSI-71-109

Excavators

Fig- 1



Fig. 2

Excavators Fig 2

PSI-71-110

Excavators



Fig. 3

Excavators Fig 3

PSI-71-111

Excavators



Fig. 4

Excavators Fig 4

PSI-71-112

Excavators



Fig. 5

Excavators Fig 5

PSI-71-113

Excavators



Fig. 6

Excavators Fig 6

PSI-71-114

Excavators



Fig. 6

Excavators Fig 6

PSI-71-115

Excavators



Fig. 14

Excavators Fig 14

PSI-71-116

Excavators

Fig. 14



Fig. 17

Excavators Fig 17

PSI-71-117

Excavators

Fig. 17



Fig. 17W

Excavators Fig 17W

PSI-71-118

Excavators



Fig. 18

Excavators Fig 18

PSI-71-119

Excavators



Fig. 18W
Oval spoon

Oval Spoon Fig 18W

PSI-71-120

Excavators



Fig. 19

Excavators Fig 19

PSI-71-121

Excavators



Fig. 19W
Oval spoon

Oval Spoon Fig 19W

PSI-71-122

Excavators



Fig. 6

Excavators Fig 6

PSI-71-123

Excavators



Fig. 14

Excavators Fig 14

PSI-71-124

Excavators

Fig. 14



Fig. 17

Excavators Fig 17

PSI-71-125

Excavators



Fig. 17W
Oval spoon

Oval Spoon Fig 17W

PSI-71-126

71-126



Fig. 18W
Oval spoon

Oval Spoon 18W

PSI-71-127

Excavators



Fig. 19

Excavators Fig 19

PSI-71-129

Excavators



Fig. 19W
Oval spoon

Oval Spoon Fig 19W

PSI-71-130

Excavators



Fig. 38/39

Excavators Fig 38/39

PSI-71-131

Excavators



Fig. 63/64

Excavators Fig 63/64

PSI-71-133

Excavators



Fig. 65/66

Excavators Fig 65/66

PSI-71-134

Excavators



Fig. 31L

Excavators Fig 31L

PSI-71-135

Excavators

Fig- 31L



Fig. 32L

Excavators Fig 32L

PSI-71-136

Excavators

Fig- 32L



Cleoid / Discoid

PSI-71-137

No. 3/6 Excavator, double end



Cleoid / Discoid

PSI-71-138

No. 89/92 Carver - Discoid \"/> Cleoid, octagonal handle

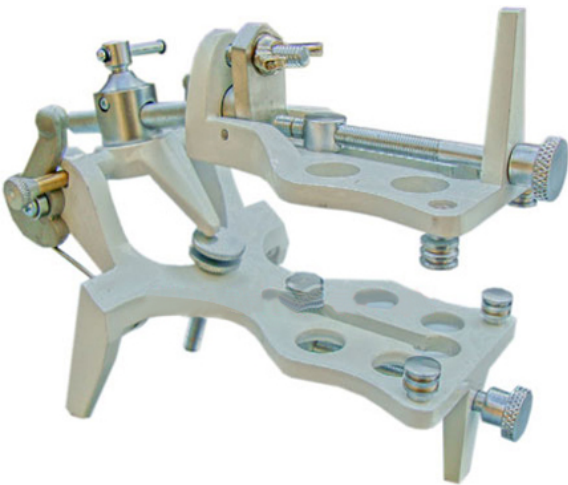

**PLASTERLESS ARTICULATOR GALETTI
(WHITE)**

PSI-81-101

HIGH TECH PLASTERLESS ARTICULATOR GALETTI WITH ADJUSTABLE SCREWS AT REARS & FRONT. SOLIDLY CO



Vibratory Polished Articulator Galetti

PSI-81-102

GALETTI ARTICULATOR IS SOLIDLY CONSTRUCTED OF METAL ALLOY CASTING. EASY TO USE, ALLOWING QUICK FI



ANATOMICAL ARTICULATOR (ASA)

PSI-81-103

ANATOMICAL ARTICULATOR WITH BEARING ROD & INCISIVE PIN, 4 MOUNTING PLATES & SUPPORTING BA



UNIVERSAL ARTICULATOR

PSI-81-104

ANATOMICAL ARTICULATOR, MADE OF ALUMINUM PRESSOFUSION OF ONLY 590/GR OF WEIGHT. REALIZED FOR EASY



Gnatus Pro JP30 Articulator

PSI-81-105

The Gnatus Pro JP30 Articulator offers the best performance with an excellent degree of accuracy.



ANATOMICAL ARTICULATOR

PSI-81-106

ANATOMICAL ARTICULATOR WITH INCISIVE PIN, 4 MOUNTING PLATES AND SUPPORTING BACK-PIN FOR 45° VIEW,



KEYSTONE BLACK ARTICULATOR WIRED

PSI-81-107

KEYSTONE DELUXE UNIVERSAL TYPE-A ARTICULATOR. INTERCHANGEABLE, INCISAL PIN INCLUDED, LATERAL EXCU



KEYSTONE DELUXE MAGNET ARTICULATOR

PSI-81-108

KEYSTONE DELUXE MAGNETIC DENTURE ARTICULATOR WITH PLATES, INTERCHANGEABLE, INCISAL PIN INCLUDED.

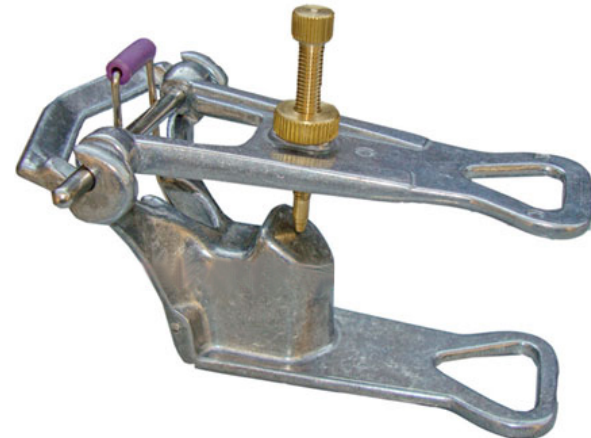

PROFESSIONAL OCCLUSOR ARTICULATOR

PSI-81-109

PROFESSIONAL OCCLUSOR, VIBRATORY POLISHED ARTICULATOR - ALUMINUM, BRASS, STAINLESS STEEL



Magicart-1 Articulator

PSI-81-110

LIGHTWEIGHT, HIGH-QUALITY MAGIC ART ARTICULATOR SECURELY HOLDS QUADRANT MODELS, CONSERVE MATERIAL



FULL DENTURE ARTICULATOR (ROUND) MODEL 'M' HI TOP STEPHAN ARTICULATOR

PSI-81-111

FULL DENTURE CHROME PLATED ARTICULATOR (3 SLOT ROUND)

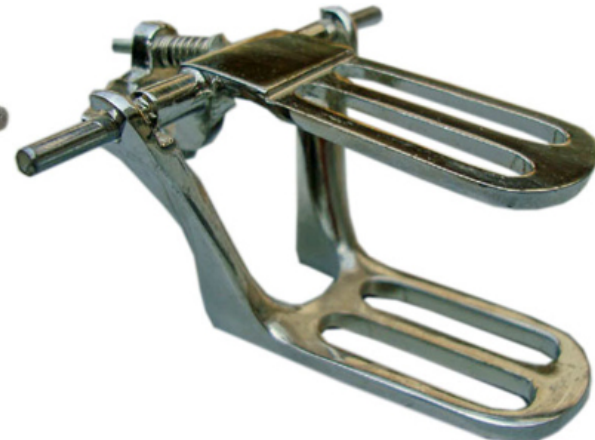

PSI-81-112

FULL DENTURE CHROMIUM PLATED ARTICULATOR. PROVIDES ADDITIONAL VERTICAL DIMENSION FOR ACCEPTANCE O



Chromium Plated Plain Round

PSI-81-113

Nickle Chromium Plated Plain Round Articulator



UNIVERSAL ARTICULATOR (YELLOW)

PSI-81-114

UNIVERSAL ARTICULATOR OPENING 125° WITH 4 MOUNTING PLATES - CONDYLAR INCLINATION FIXED AT 30°, INT



FOSTER DENTURE ARTICULATOR

PSI-81-115

THIS ARTICULATOR IS EQUIPPED WITH AN ADJUSTABLE ANTERIOR PIN STOP & POSTERIOR SCREW STOP, AND



FORK CHROME PLATED ARTICULATOR

PSI-81-116

NICKLE CHROMIUM PLATED ARTICULATOR FORK PATTERN



HINGE ARTICULATOR FULL ARCH

PSI-81-117

AN ECONOMICAL & SIMPLE CHROMIUM PLATED HINGE ARTICULATOR FOR MOUNTING FULL ARCH CASES. LOW BA



QUADRANT / CROWNED BRIDGE ARTICULATOR

PSI-81-118

BRASS HINGE CROWNED BRIDGE ARTICULATOR FOR MOUNTING QUADRANT CASES. CROWN & BRIDGE ARTICULATOR



UNIVERSAL ARTICULATOR (BLUE)

PSI-81-119

UNIVERSAL ARTICULATOR OPENING 125° WITH 4 MOUNTING PLATES - CONDYLAR INCLINATION FIXED AT 30°, INT



FOSTER / APEX # 2 ARTICULATOR

PSI-81-120

FOSTER / APEX # 2 ARTICULATOR, THE WIDTH AT THE JOINT IS 1-3/4" WITH A VERTICAL PARALLEL HEIGHT O



MORTIMER-I OCULADER ARTICULATOR

PSI-81-121

PLAINLINE BALL BEARING MORTIMER-I OCULADER ARTICULATOR. ALL FILLED WITH HIGH CARBON STEEL BALLS F



MORTIMER-II OCULADER ARTICULATOR

PSI-81-122

PLAINLINE BALL BEARING MORTIMER-II OCULADER ARTICULATOR. ALL FILLED WITH HIGH CARBON STEEL BALLS.

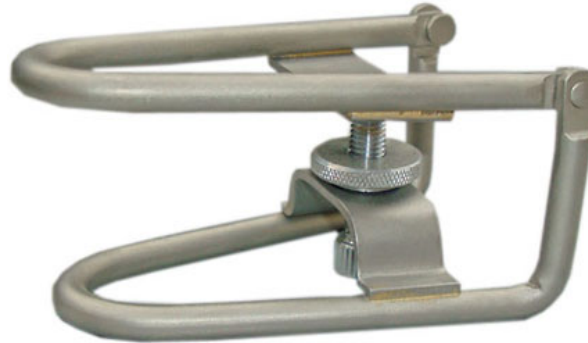

OCCLUSOR, WIRE ARTICULATOR

PSI-81-123

OCCLUSOR, WIRE ARTICULATOR - STAINLESS STEEL & ALUMINUM



ASA Articulator 5002

PSI-81-124

ASA ARTICULATOR WITH LATERAL MOMENT. MADE OF ALUMINUM DIE CASTING WITH 2 MOUNTING PLATES. ALSO AV



Model "A" Crescent Stephan Articulator

PSI-81-125

CRESCENT STEPHAN MODEL "A" ARTICULATOR IS USED FOR PARTIALS,
CENTER SPRING WITH ADJUSTABLE TENSIO



Bite Fork / Occlusal Alignment Plane

PSI-81-126

BITE FORK IS A RELIABLE INSTRUMENT FOR CHECKING THE CORRECT
POSITION OF THE MASTICATORY PLANE, AC



Dental Syringes

PSI-75-101

Dental Syringes



Dental Syringes

PSI-75-102

Dental Syringes



Self Aspirating 1.8cc

PSI-75-103

Dental Syringes



Cylinder Cartridge Syringe

PSI-75-104

Dental Syringes



Dental Syringes

PSI-75-105

Dental Syringes



Dental Syringes

PSI-75-106

Dental Syringes



Dental Syringes

PSI-75-107

Dental Syringes



C-W 1.8cc

PSI-75-108

Dental Syringes



Dental Syringes

PSI-75-109

Dental Syringes



Dental Syringes

PSI-75-110

Dental Syringes



Dental Syringes

PSI-75-111

Dental Syringes



Dental Syringes

PSI-75-112

Dental Syringes



Dental Syringes

PSI-75-113

Dental Syringes



Dental Syringes

PSI-75-118

Dental Syringes

Fig- 1



Dental Syringes

PSI-75-119

Aspira-Plus



Dental Syringes

PSI-75-120

Dental Syringes



Dental Syringes

PSI-75-122

Dental Syringes



Dental Syringes

PSI-75-124

Dental Syringes



Dental Syringes

PSI-75-126

Dental Syringes



Dental Syringes

PSI-75-127

Dental Syringes



Dental Syringe

PSI-75-128

Aspira-Plus



Dental Syringe

PSI-75-129

Dental Syringe



Dental Syringe

PSI-

Dental Syringe



Dental Syringe

PSI-75-131

Dental Syringe



Dental Syringe

PSI-75-132

Dental Syringe

DENTAL INSTRUMENTS

Miscellaneous Laboratory Instruments



Bandage And Utility Scissors

PSI-82-101

Bandage and Utility Scissors, 7-1/2" (19.1 cm), needle destroyer, serrated blade, autoclavable



Plaster And Compound Knife

PSI-82-102

Plaster and Compound Knife



Soldering Tweezers, Curved

PSI-82-103

Soldering Tweezers, curved



SWISS Jeweler Style Forceps

PSI-82-104

SWISS Jeweler style Forceps, non-magnetic stainless steel, style 3, narrow, fine, 4-3/4" (12.1 cm)



SWISS Jeweler Style Forceps

PSI-82-105

SWISS Jeweler style Forceps, non-magnetic stainless steel, style 5, Super fine, 4-3/8" (11.2 cm)



SWISS Jeweler Style Forceps

PSI-82-106

SWISS Jeweler style Forceps, non-magnetic stainless steel, style 7, fine, curved, 4-1/2" (11.4 cm)

DENTAL INSTRUMENTS

Miscellaneous Laboratory Instruments



Calipers

PSI-82-107

Calipers



Calipers

PSI-82-108

Calipers



Steel Ruler

PSI-82-109

Steel Ruler



Forceps For Articulation Paper

PSI-82-110

Forceps for articulation paper



LISTER Bandage Scissors

PSI-61-101

GUM Scissors

Extra fine



LISTER Bandage Scissors

PSI-61-102

Gum Scissors

Extra fine



LISTER Bandage Scissors

PSI-61-103

Gum Scissors

Extra fine



KNOWLES Bandage Scissors

PSI-61-104

Gum Scissors

Straight



HEATH Suture Scissors

PSI-61-105

Gum Scissors

Serrated blade



SPENCER Stitch Scissors

PSI-61-106

Gum Scissors

Delicate



SHORTBENT Stitch Scissors

PSI-61-107

Gum Scissors Curved delicate



LITTAUER JR. Stitch Scissors

PSI-61-108

Gum Scissors



NORTHBENT Stitch Scissors

PSI-61-109

Gum Scissors Curved light pattern



LITTAUER Stitch Scissors

PSI-61-110

Gum Scissors Standard pattern



LONG Oral Surgery Stitch Scissors

PSI-61-111

Gum Scissors



MILTEX Stitch Scissors

PSI-61-112

Gum Scissors Angled delicate



REEH Stitch Scissors

PSI-61-113

Gum Scissors

Sharp tips small hook on 1 blade ribbon type



MILTEX Stitch Scissors

PSI-61-114

Gum Scissors Curved sharp pointed tips ribbon

type



MILTEX Stitch Scissors

PSI-61-115

Gum Scissors Curved sharp pointed tips ribbon

type



VANTAGE Crown Scissors

PSI-61-116

Gum Scissors Collar curved



VANTAGE Collar

PSI-61-117

Gum Scissors Crown Scissors straight



MILTEX Wire Cutting Scissors

PSI-61-118

Gum Scissors Angled to side one serrated blade



MILTEX Wire Cutting Scissors

PSI-61-119

Gum Scissors Angled to side, one serrated blade,
Carb-N-Sert inserts



Standard Pattern Operating Scissors

PSI-61-120

Gum Scissors Straight sharp-sharp points



Standard Pattern Operating Scissors

PSI-61-121

Gum Scissors Straight sharp-sharp points



Standard Pattern Operating Scissors

PSI-61-122

Gum Scissors Straight sharp-blunt points



Standard Pattern Operating Scissors

PSI-61-123

Gum Scissors Straight sharp-blunt points



Standard Pattern Operating Scissors

PSI-61-124

Gum Scissors Straight sharp-blunt points



Standard Pattern Operating Scissors

PSI-61-125

Gum Scissors Curved sharp/sharp points



Standard Pattern Operating Scissors

PSI-61-126

Gum Scissors Curved sharp/sharp points



Standard Pattern Operating Scissors

PSI-61-127

Gum Scissors Curved



Standard Pattern Operating Scissors

PSI-61-128

Gum Scissors Curved, sharp-blunt points



MAYO Dissecting Scissors

PSI-61-129

Gum Scissors Straight, standard beveled blades



MAYO Dissecting Scissors

PSI-61-130

Gum Scissors Straight, standard beveled blades



MAYO Dissecting Scissors

PSI-61-131

Gum Scissors Curved, standard beveled blades



MAYO Dissecting Scissors

PSI-61-132

Gum Scissors Curved, standard beveled blades



Delicate Pattern METZENBAUM Scissors

PSI-61-133

Gum Scissors
Straight, blunt points



Delicate Pattern METZENBAUM Scissors

PSI-61-134

Gum Scissors
Straight, sharp points



Standard Pattern METZENBAUM Scissors

PSI-61-135

Gum Scissors
Curved, blunt points



Standard Pattern METZENBAUM Scissors

PSI-61-136

Gum Scissors
Curved, blunt points



**Delicate Pattern METZENBAUM
Scissors**

PSI-61-137

Gum Scissors
Curved, blunt points



**Delicate Pattern METZENBAUM
Scissors**

PSI-61-138

Gum Scissors
Curved, sharp points



KELLY Scissors

PSI-61-139

Gum Scissors
Straight, sharp points



KELLY Scissors

PSI-61-140

Gum Scissors
Curved, sharp points



KELLY Scissors

PSI-61-141

Gum Scissors
Sharp points, angled on side



**KAYE Blepharoplasty And Dissecting
Scissors**

PSI-61-142

Gum Scissors
One serrated blade, ribbon type



DEAN Dissecting Scissors

PSI-61-143

Gum Scissors

Blades angled on flat, one serrated blade



KAYE Dissecting Scissors

PSI-61-144

Gum Scissors

Curved, one serrated blade



WAGNER Plastic Surgery Scissors

PSI-61-145

Gum Scissors

Straight, sharp-sharp points, serrated blade



WAGNER Plastic Surgery Scissors

PSI-61-146

Gum Scissors

Straight, sharp-sharp points, serrated blade



WAGNER Plastic Surgery Scissors

PSI-61-147

Gum Scissors

Straight, sharp-blunt points



WAGNER Plastic Surgery Scissors

PSI-61-148

Gum Scissors

Straight, sharp-blunt points, serrated blade



WAGNER Plastic Surgery Scissors

PSI-61-149

Gum Scissors

Straight, blunt-blunt points



WAGNER Plastic Surgery Scissors

PSI-61-150

Gum Scissors

Straight, blunt-blunt points, serrated blade



WAGNER Plastic Surgery Scissors

PSI-61-151

Gum Scissors

Curved, sharp-sharp points



WAGNER Plastic Surgery Scissors

PSI-61-152

Gum Scissors

Curved, sharp-sharp points, serrated blade



WAGNER Plastic Surgery Scissors

PSI-61-153

Gum Scissors

Curved, sharp-blunt points



WAGNER Plastic Surgery Scissors

PSI-61-154

Gum Scissors

Curved, sharp-blunt points, serrated blade



WAGNER Plastic Surgery Scissors

PSI-61-155

Gum Scissors

Curved, blunt-blunt points



WAGNER Plastic Surgery Scissors

PSI-61-156

Gum Scissors

Curved, blunt-blunt points, serrated blade



WAGNER Plastic Surgery Scissors

PSI-61-157

Gum Scissors

Straight, sharp-sharp points



WAGNER Plastic Surgery Scissors

PSI-61-158

Gum Scissors

Straight, sharp-sharp point, serrated blade



Delicate Pattern METZENBAUM Scissors

PSI-61-159

Gum Scissors

Curved



Iris Scissors

PSI-61-160

Gum Scissors

Straight



Iris Scissors

PSI-61-161

Gum Scissors

Curved



Iris Scissors

PSI-61-162

Gum Scissors

Straight



Iris Scissors

PSI-61-163

Gum Scissors

Straight



Iris Scissors

PSI-61-164

Gum Scissors

Curved



Iris Scissors

PSI-61-165

Gum Scissors

Curved



Iris Scissors

PSI-61-166

Gum Scissors

Angled on side



BROPHY Scissors

PSI-61-167

Gum Scissors

Straight, sharp points



BROPHY Scissors

PSI-61-168

Gum Scissors

Curved, sharp points



GOLDMAN-FOX Scissors

PSI-61-169

Gum Scissors

Curved fine tips, one serrated blade



GOLDMAN-FOX Scissors

PSI-61-170

Gum Scissors

Curved fine tips, one serrated blade



KELLY Scissors

PSI-61-171

Gum Scissors

Sharp points, straight, one serrated blade



KELLY Scissors

PSI-61-172

Gum Scissors

Sharp points, curved, one serrated blade



KELLY Scissors

PSI-61-173

Gum Scissors

Sharp points, angular, one serrated blade



Iris Operating Scissors

PSI-61-174

Gum Scissors

Curved sideways



GOLDMAN-FOX Scissors

PSI-61-175

Gum Scissors

Curved, one serrated blade, angled shank



LA GRANGE Scissors

PSI-61-176

Gum Scissors

Curved, one serrated blade, angled shank



BROPHY Operating Scissors

PSI-61-177

Gum Scissors

Curved, sharp/sharp, with one serrated blade



LOCKLIN Operating Scissors

PSI-61-178

Gum Scissors

Angled on side 25 degrees, one serrated blade



LOCKLIN Operating Scissors

PSI-61-179

Gum Scissors

Curved shank, angled on side 25 degrees, one serrated blade



**MILTEX SuperCut GOLDMAN-FOX
Gum Scissors**

PSI-61-180

Gum Scissors

Curved



HEATH Suture Scissors

PSI-61-181

Gum Scissors

Serrated blade



Iris Scissors

PSI-61-182

Gum Scissors

Straight, with 20 mm blades, delicate



Iris Scissors

PSI-61-183

Gum Scissors

Curved, with 20 mm blades, delicate



NOYES (ROSS) Iris Scissors

PSI-61-184

Gum Scissors

Curved, sharp/sharp points



CASTROVIEJO Corneal Scissors

PSI-61-185

Gum Scissors

Curved, sharp points



QUIMBY Gum Scissors

PSI-61-186

Gum Scissors

Strongly curved and pointed, smooth blades 15 mm



JOSEPH Scissors

PSI-61-187

Gum Scissors

Straight



JOSEPH Scissors

PSI-61-188

Gum Scissors

Curved



Matrix Retainer Tofflemire

PSI-80-101

MATRIX BAND RETAINER TOFFLEMIRE.

AVAILABLE IN STRAIGHT & CONTRA. STAINLESS

STEEL



Tofflemire Matrix Retainer Junior / Child

PSI-80-102

MATRIX BAND RETAINER TOFFLEMIRE JUNIOR /

CHILD. AVAILABLE IN STRAIGHT & CONTRA.

STAINLESS ST



Tofflemire Matrix Retainer Senior / Adult

PSI-80-103

MATRIX BAND RETAINER TOFFLEMIRE SENIOR /

CHILD. AVAILABLE IN STRAIGHT & CONTRA.

STAINLESS ST



Tofflemire Matrix Retainer Universal

PSI-80-104

MATRIX BAND RETAINER TOFFLEMIRE

UNIVERSAL. AVAILABLE IN STRAIGHT & CONTRA.

STAINLESS STEEL



Matrix Band Retainer Ivory 8

PSI-80-105

MATRIX BAND RETAINER IVORY 8, AVAIALBE IN

5MM, 6MM, 7MM. STAINLESS STEEL



Matrix Band Retainer Ivory Plain

PSI-80-106

MATRIX RETAINER IVORY PLAIN / WITHOUT

LATERAL SHIELD (JAW). STAINLESS STEEL



Matrix Retainer Ivory With Shield

PSI-80-107

MATRIX RETAINER IVORY WITH LATERAL SHIELD
(JAW). STAINLESS STEEL



Matrix Retainer Cheek Protector

PSI-80-108

MATRIX BAND RETAINER CHEEK PROTECTOR.
STAINLESS STEEL



Matrix Band Retainer Nystrom Left

PSI-80-109

MATRIX BAND RETAINER NYSTROM LEFT.
STAINLESS STEEL



**Matrix Band Retainer Nystrom
Right**

PSI-80-110

MATRIX BAND RETAINER NYSTROM RIGHT.
STAINLESS STEEL



**Matrix Band Retainer Siqueland
(Ash Narrow)**

PSI-80-111

MATRIX BAND RETAINER SIQUELAND (ASH
NARROW). STAINLESS STEEL



**Matrix Band Retainer Siqueland
(Ash Wide)**

PSI-80-112

MATRIX BAND RETAINER SIQUELAND (ASH WIDE).
STAINLESS STEEL



**Matrix Band Retainer Ivory Didner
(Adjustable)**

PSI-80-113

Matrix Band Retainer Ivory Didner (Adjustable)



Matrix Retainer Ivory Separator

PSI-80-114

MATRIX BAND RETAINER IVORY SEPARATOR.
STAINLESS STEEL



Matrix Retainer Elliott Separator

PSI-80-115

MATRIX RETAINER ELLIOTE SEPARATOR.
STAINLESS STEEL



Matrix Retainer Ivory 8 N

PSI-80-116

MATRIX BAND RETAINER IVORY 8N. MADE OF
STAINLESS STEEL



Matrix Retainer Didner 8 P

PSI-80-117

MATRIX BAND RETAINER IVORY 8P. MADE OF
STAINLESS STEEL



Heister

PSI-63-141

Mouth Gags,



MOLT PEDIATRIC

PSI-63-142

Mouth Gags,



MOLT CHILD

PSI-63-143

Mouth Gags,



MOLT ADULT

PSI-63-144

Mouth Gags,
140 mm, 5"



FERGUSSON-ACKLAND

PSI-63-145

Mouth Gags,
145 mm, 5"



DENHART

PSI-63-146

Mouth Gags,
5"



ROSER-KONIG

PSI-63-147

Mouth Gags,



ROSER-KONIG

PSI-63-148

Mouth Gags,
185 mm, 7



LANGENBECK

PSI-63-149

Finger Protectors
185 mm, 7



**Tongue Depressor And Cheek
Retractors**

PSI-63-150

Tongue Depressor and Cheek Retractors

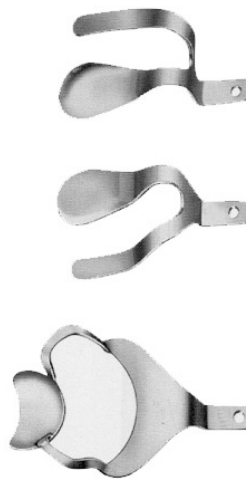

Retractor

PSI-63-151

Mouth Gags,



HARTMANN

PSI-63-152

Retractors
145 mm, 5"



Retractor

PSI-63-153

Mouth Gags,
140 mm, 5"



SCHMID

PSI-63-154

Mouth Gags,
140 mm, 5"



Retractor

PSI-63-155

Mouth Props
140 mm, 5"



Retractor

PSI-63-156

Retractors
6"



VESTIBULUM RETRACTOR

PSI-63-157

Retractors
140 mm, 5"



STERNBERG

PSI-63-158

Retractors



ROUX
PSI-63-159
Retractors



ROUX
PSI-63-160
Retractors



ROUX
PSI-63-161
Retractors



MIDDELDORPF
PSI-63-162
Retractors
200 mm, 8"



MIDDELDORPF
PSI-63-163
Retractors
8"



MIDDELDORPF
PSI-63-164
Cheek Retractors



Gauze Case

PSI-63-165

Gauze Case

9



Retractor

PSI-63-166

Retractors

6



Retractor

PSI-63-167

Retractor

6



Retractor

PSI-63-168

Retractor

6



Retractor

PSI-63-169

Retractor

6



Retractor

PSI-63-170

Retractor

6



Retractor

PSI-63-171

Retractor

6



Retractor

PSI-63-172

Retractors

6



Retractor

PSI-63-173

Retractors

6



Retractor

PSI-63-174

Retractors

6



Retractor

PSI-63-175

Retractors

6



LANGENBECK-GREEN

PSI-63-176

Retractors



Fig. 79
135/162
Kirkland

Kirkland

PSI-64-101

Periodontia Instruments



Fig. 172
Orban

Orban

PSI-64-102

Periodontia Instruments



Fig. 172
Orban

Orban

PSI-64-104

Periodontia Instruments



Fig. 7
Goldman-Fox

Goldman-Fox

PSI-64-105

Periodontia Instruments



Fig. 8
Goldman-Fox

Goldman-Fox

PSI-64-106

Periodontia Instruments



Fig. 9
Goldman-Fox

Goldman-Fox

PSI-64-107

Periodontia Instruments



Fig. 1/2
PSI-64-103
Kirkland

Kirkland

PSI-64-103

Periodontia Instruments



Fig. 11
Goldman-Fox

Goldman-Fox

PSI-64-108

Periodontia Instruments

Fig. 11



Fig. 3/4
Buck

Buck

PSI-64-109

Periodontia Instruments

Fig- 3/4



Fig. 5/6
Buck

Buck

PSI-64-110

Periodontia Instruments

Fig- 5/6



Fig. 7
Goldman-Fox

Goldman-Fox

PSI-64-111

Periodontia Instruments



Fig. 9
Goldman-Fox

Goldman-Fox

PSI-64-112

Periodontia Instruments



Fig. 9
Goldman-Fox

Goldman-Fox

PSI-64-113

Periodontia Instruments



Fig. 11
Goldman-Fox

Goldman-Fox

PSI-64-114

Periodontia Instruments

Fig. 11



Fig. 3/4
Buck

Buck

PSI-64-115

Periodontia Instruments

Fig- 3/4



Fig. 5/6
Buck

Buck

PSI-64-116

Periodontia Instruments

Fig- 5/6



Fig. 1/2
Sanders

Sanders

PSI-64-117

Periodontia Instruments



Fig. 4/5
Sanders

Sanders

PSI-64-118

Periodontia Instruments



Fig. 18/20

OCHSENBEIN CHISEL NO 4

PSI-64-119

Periodontia Instruments



Fig. 5/6
Buck

Crane-Kaplan

PSI-64-120

Periodontia Instruments



Fig. 11/2
Sander

Sanders

PSI-64-121

Periodontia Instruments



Fig. 4/5
Sander

Sanders

PSI-64-122

Periodontia Instruments



Fig. 19/20

OCHSENBEIN CHISEL NO 4

PSI-64-123

Periodontal Instruments



Fig. CK3
Crane-Kaplan

Crane-Kaplan

PSI-64-124

Periodontia Instruments



Fig. HU 1/2
Curette

Curette

PSI-64-125

Periodontia Instruments



Fig. 2R/2L
Columbia

Columbia

PSI-64-126

Periodontia Instruments



Fig. 4R/4L
Columbia

Columbia

PSI-64-127

Periodontia Instruments



Fig. 13/14
Columbia

Columbia

PSI-64-128

Periodontia Instruments



Fig. 411/412

Periodontia Instruments

PSI-64-129

Periodontia Instruments



Fig. 413/414

Periodontia Instruments

PSI-64-130

Periodontia Instruments



Zerling-Chiles

Zerling-Chiles

PSI-64-131

Periodontia Instruments



Fig. HJ 1/2
Curette

Curette

PSI-64-132

Periodontia Instruments



Fig. 29/2L
Columbia

Columbia

PSI-64-133

Periodontia Instruments



Fig. 4R/4L
Columbia

Columbia

PSI-64-134

Periodontia Instruments



Fig. 13/14
Columbia

Columbia

PSI-64-135

Periodontia Instruments



Fig. 1/2
Langer

Langer

PSI-64-136

Periodontia Instruments



Fig. 3/4
Langer

Langer

PSI-64-137

Periodontia Instruments

Fig- 3/4



Fig. 1/2
Barnhart

Barnhart

PSI-64-138

Periodontia Instruments



Fig. 5/6
Barnhart

Barnhart

PSI-64-139

Periodontia Instruments

Fig- 5/6



Fig. ME-1
(10/11)

Periodontia Instruments

PSI-64-140

Periodontia Instruments



Fig. 3/4
P/6 (23/24)

Periodontia Instruments

PSI-64-141

Periodontia Instruments

Fig- 3/4



Fig. 1/2
Langer

Langer

PSI-64-142

Periodontia Instruments



Fig. 3/4
Langer

Langer

PSI-64-143

Periodontia Instruments

Fig- 3/4



Fig. 1/2
Barnhart

Barnhart

PSI-64-144

Periodontia Instruments



Fig. 5/6
Barnhart

Barnhart

PSI-64-145

Periodontia Instruments

Fig- 5/6



Fig. ME-1
[10/11]

Periodontia Instruments

PSI-64-146

Periodontia Instruments



Fig. 3/4
Rue [23/24]

Periodontia Instruments

PSI-64-147

Periodontia Instruments

Fig- 3/4



Fig. 1/2
Gracey

Gracey

PSI-64-148

Periodontia Instruments



Fig. 3/4
Gracey

Gracey

PSI-64-149

Periodontia Instruments

Fig- 3/4



Fig. 5/6
Gracey

Gracey

PSI-64-150

Periodontia Instruments

Fig- 5/6



Fig. 7/8
Gracey

Gracey

PSI-64-151

Periodontia Instruments



Fig. 9/10
Gracey

Gracey

PSI-64-152

Periodontia Instruments



Fig. 11/12
Gracey

Gracey

PSI-64-153

Periodontia Instruments



Fig. 13/14
Gracey

Gracey

PSI-64-154

Periodontia Instruments



Fig. 1/2
Gracey

Gracey

PSI-64-155

Periodontia Instruments



Fig. 3/4
Gracey

Gracey

PSI-64-156

Periodontia Instruments

Fig- 3/4



Fig. 5/6
Gracey

Gracey

PSI-64-157

Periodontia Instruments

Fig- 5/6



Fig. 7/8
Gracey

Gracey

PSI-64-158

Periodontia Instruments



Fig. 9/10
Gracey

Gracey

PSI-64-159

Periodontia Instruments



Fig. 11/12
Gracey

Gracey

PSI-64-160

Periodontia Instruments



Fig. 13/14
Gracey

Gracey

PSI-64-161

Periodontia Instruments



Fig. 11/14
Gracey

Gracey

PSI-64-162

Periodontia Instruments



Fig. 12/13
Gracey

Gracey

PSI-64-163

Periodontia Instruments



Fig. 1
De Marco

Ce Marco

PSI-64-164

Periodontia Instruments

Fig- 1



Fig. 2
De Marco

De Marco

PSI-64-165

Periodontia Instruments



Fig. 13/14
Anterior

Anterior

PSI-64-166

Periodontia Instruments



Fig. 17/18
Posterior

Posterior

PSI-64-167

Periodontia Instruments



Fig. 11/14
Gracey

Gracey

PSI-64-168

Periodontia Instruments



Fig. 12/13
Gracey

Gracey

PSI-64-169

Periodontia Instruments



Fig. 1
De Marco

De Marco

PSI-64-170

Periodontia Instruments

Fig- 1



Fig. 2
De Marco

De Marco

PSI-64-171

Periodontia Instruments



Fig. 13/14
Anterior

Anterior

PSI-64-172

Periodontia Instruments



Fig. 17/18
Posierior

Posierior

PSI-64-173

Periodontia Instruments



Fig. 1
Goldman-Fox

Goldman-Fox

PSI-64-174

Periodontia Instruments

Fig- 1



Fig. 2
Goldman-Fox

Goldman-Fox

PSI-64-175

Periodontia Instruments



Fig. 3
Goldman-Fox

Goldman-Fox

PSI-64-176

Periodontia Instruments



Fig. 4
Goldman-Fox

Goldman-Fox

PSI-64-177

Periodontia Instruments



Fig. 5
Goldman-Fox

Goldman-Fox

PSI-64-178

Periodontia Instruments



Fig. 6
Goldman-Fox

Goldman-Fox

PSI-64-179

Periodontia Instruments



Fig. 71
Goldman-Fox

Goldman-Fox

PSI-64-180

Periodontia Instruments



Fig. 1
Goldman-Fox

Goldman-Fox

PSI-64-181

Periodontia Instruments

Fig- 1



Fig. 2
Goldman-Fox

Goldman-Fox

PSI-64-182

Periodontia Instruments



Fig. 3
Goldman-Fox

Goldman-Fox

PSI-64-183

Goldman-Fox



Fig. 4
Goldman-Fox

Goldman-Fox

PSI-64-184

Periodontia Instruments



Fig. 5
Goldman-Fox

Goldman-Fox

PSI-64-185

Periodontia Instruments



Fig. 6
Goldman-Fox

Goldman-Fox

PSI-64-186

Periodontia Instruments



Fig. 21
Goldman-Fox

Goldman-Fox

PSI-64-187

Periodontia Instruments



Fig. 11/12
Mc Call

Mc Call

PSI-64-188

Periodontia Instruments



Fig. 11A/12A
Mc Call

Mc Call

PSI-64-189

Periodontia Instruments



Fig. 13/14
Mc Call

Mc Call

PSI-64-190

Periodontia Instruments



Fig. 135/145
Mc Call

Mc Call

PSI-64-191

Periodontia Instruments



Fig. 175/185
Mc Call

Mc Call

PSI-64-192

Periodontia Instruments



Fig. 19/20
Mc Call

Mc Call

PSI-64-193

Periodontia Instruments



Fig. 11/12
Mc Call

Mc Call

PSI-64-194

Periodontia Instruments



Fig. 11A/12A
Mc Call

Mc Call

PSI-64-195

Periodontia Instruments



Fig. 13/14
Mc Call

Mc Call

PSI-64-196

Periodontia Instruments



Fig. 135/145
Mc Call

Mc Call

PSI-64-197

Periodontia Instruments



Fig. 175/185
Mc Call

Mc Call

PSI-64-198

Periodontia Instruments



Fig. 19/20
Mc Call

Mc Call

PSI-64-199

Periodontia Instruments



Fig. 2/3
Taylor

Taylor

PSI-64-200

Periodontia Instruments



Fig. 204

Periodontia Instruments

PSI-64-201

Periodontia Instruments



Fig. 204S

Periodontia Instruments

PSI-64-202

Periodontia Instruments



Fig. 204S

Periodontia Instruments

PSI-64-203

Periodontia Instruments



Fig. 6
Crane-Kaplan

Crane-Kaplan

PSI-64-204

Periodontia Instruments



Fig. 7/8
Younger-Good

Younger-Good

PSI-64-205

Periodontia Instruments



Fig. 273
Taylor

Taylor

PSI-64-206

Periodontia Instruments



Fig. 204

Periodontia Instruments

PSI-64-207

Periodontia Instruments



Fig. 204S

Periodontia Instruments

PSI-64-208

Periodontia Instruments



Fig. 204S

Periodontia Instruments

PSI-64-209

Periodontia Instruments



Fig. 5
Crane-Kaplan

Crane-Kaplan

PSI-64-210

Periodontia Instruments



Fig. 7/8
Younger-Good

Younger-Good

PSI-64-211

Periodontia Instruments



Fig. 3/7
Hirschfeld

Hirschfeld

PSI-64-212

Periodontia Instruments



Fig. 28/31
Jaquette

Jaquette

PSI-64-213

Periodontia Instruments



Fig. 31/32
Jaquette

Jaquette

PSI-64-214

Periodontia Instruments



Fig. 31/32
Jaquette

Jaquette

PSI-64-215

Periodontia Instruments



Fig. 317
Hirschfeld

Hirschfeld

PSI-64-216

Periodontia Instruments



Fig. 30/33
Jaquette

Jaquette

PSI-64-217

Periodontia Instruments



Fig. 31/32
Jaquette

Jaquette

PSI-64-218

Periodontia Instruments



Fig. 34/35
Hirschfeld

Jaquette

PSI-64-219

Periodontia Instruments



Fig. 37/38
Jaquette

Jaquette

PSI-64-220

Periodontia Instruments



Fig. 1
Ochsenbein

Ochsenbein

PSI-64-221

Periodontia Instruments

Fig- 1



Fig. 2
Ochsenbein

Ochsenbein

PSI-64-222

Periodontia Instruments



Fig. 1
Gardner

Gardner

PSI-64-223

Periodontia Instruments

Fig- 1



Fig. 2
Gardner

Gardner

PSI-64-224

Periodontia Instruments



Fig. 5
Gardner

Gardner

PSI-64-225

Periodontia Instruments



Fig. 5R
Gardner

Gardner

PSI-64-226

Periodontia Instruments



Fig. 6
Gardner

Gardner

PSI-64-227

Periodontia Instruments



Fig. 1W
Wakefield

Wake Old

PSI-64-228

Periodontia Instruments



Fig. 2W
Wakefield

Wake Old

PSI-64-229

Periodontia Instruments



Fig. 3
Buckley

Buckley

PSI-64-230

Periodontia Instruments



Fig. MB
Molt

Molt

PSI-64-231

Periodontia Instruments



Fig. PR3
Prichard

Prichard

PSI-64-232

Periodontia Instruments



Fig. 1
Hopkins

Hopkins

PSI-64-233

Periodontia Instruments

Fig- 1



Fig. 2
Hopkins

Hopkins

PSI-64-234

Periodontia Instruments



Fig. 5
Frerr

Frerr

PSI-64-235

Periodontia Instruments



Fig. 16
Frerr

Frerr

PSI-64-236

Periodontia Instruments



Fig. 3
Mead

Mead

PSI-64-237

Periodontia Instruments



Fig. 23
Seldin Retractor

Seldin Retractor

PSI-64-238

Periodontia Instruments



Williger
cm. 17

Williger

PSI-64-239

Periodontia Instruments



Williger
cm. 16

Williger

PSI-64-240

Periodontia Instruments



Williger
cm. 16

Williger

PSI-64-241

Periodontia Instruments



Williger
cm. 13

Williger

PSI-64-242

Periodontia Instruments



Fig. 1S/2S
Sugarman

Sugarman

PSI-64-243

Periodontia Instruments



Fig. 3S/4S
Sugarman

Sugarman

PSI-64-244

Periodontia Instruments



Fig. 1/2
TG Chisel

TG Chsel

PSI-64-245

Periodontia Instruments



Fig. 1/2
TG Chisel

TG Chsel

PSI-64-246

Periodontia Instruments



Fig. 1
TG Chisel

TG Chsel

PSI-64-247

Periodontia Instruments

Fig- 1



Fig. 2
TG Chisel

TG Chsel

PSI-64-248

Periodontia Instruments



Fig. 1
(15K)
Kirkland

Kirkland

PSI-64-249

Periodontia Instruments

Fig- 1



Fig. 2
(16K)
Kirkland

Kirkland

PSI-64-250

Periodontia Instruments



Fig. 1
Orban

Orban

PSI-64-251

Periodontia Instruments

Fig- 1



Fig. 2
Orban

Orban

PSI-64-252

Periodontia Instruments

Contact Us For Superior Service

 Airport Road, Opposite. PSO Petrol Pump, 51340, Sialkot-Pakistan.

 +92 52 4263703

 +92 52 4291383

 info@psislk.com

 +92 333 8566685

 Laryngoscope2



CONTACT US