





Plastic Body, Mini Fiber Optic (2.5 V)
Standard illumination

PSI-201 Black, PSI-202 Blue, PSI-203 Green, PSI-204 Red, With 08 disposable specula, supplied in

Plastic Body, Mini Standard (2.5 V)
Standard illumination

PSI-205 Black, PSI-206 Blue, PSI-207 Green, PSI-208 Red, With 08 disposable specula, supplied in



Metal Body, Fiber Optic (2.5 V)
Standard illumination

PSI-217, Complete with handle and 08 disposable specula, 01 Spare Halogen lamps, supplied in hard



Metal Body, Fiber Optic (2.5 V)
Standard illumination

PSI-219, Complete with handle and 08 disposable specula, 01 Spare Halogen lamps, supplied in hard



Plastic Body, Mini Fiber Optic (2.5 V)
Standard illumination

PSI-209 Black, PSI-210 Blue, PSI-211 Green, PSI-212 Red, With 08 disposable specula, supplied in

Plastic Body, Mini Standard (2.5 V)
Standard illumination

PSI-213 Black, PSI-214 Blue, PSI-215 Green, PSI-216 Red, With 08 disposable specula, supplied in

MEGALIGHT F.O.



Macintosh blades with *integrated* fibre-optic illumination
Macintosh Spatel mit *integrierter* Fiber Optik

Neu
Jetzt 25% mehr Licht
durch XENON-Lampe

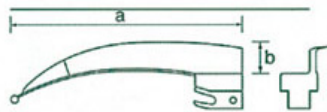

MEGALIGHT

Size	REF	mm
0	0001	83 x 14
1	0002	93 x 15
2	0003	119 x 20
3	0004	133 x 20
4	0005	155 x 20



PSI laryngoscopes are modern, extremely reliable and durable quality instruments and correspond to international standard DIN 58870. An efficient 4.5 mm **Xenon** light guarantees an excellent illumination. The Xenon lamp is integrated in the handle of all *PSI* fibre-optic laryngoscopes. A good visibility increases the security for doctor and patients at the intubation process. A wide range of blades of various sizes enables the adaptation to most difficult anatomical circumstances.



Die *PSI* Laryngoskope sind moderne, äußerst zuverlässige und langlebige Qualitäts-instrumente und entsprechen dem internationalen Standard DIN 58870. Ein leistungsstarkes 4,5-mm-**Xenon**licht gewährleistet eine hervorragende Ausleuchtung. Bei allen *PSI* Fiber Optik-Laryngoskopen ist die **Xenon**lampe im Griff integriert. Gute Sicht erhöht die Sicherheit für Arzt und patienten beim intubationsvorgang. Ein umfangreiches Sortiment von Spateln verschiedener Größen ermöglicht die Anpassung an schwierigste anatomische Verhältnisse.

①

Macintosh blades with *replaceable* fibre-optics
Macintosh Spatel mit *auswechselbarer* Fiber Optik

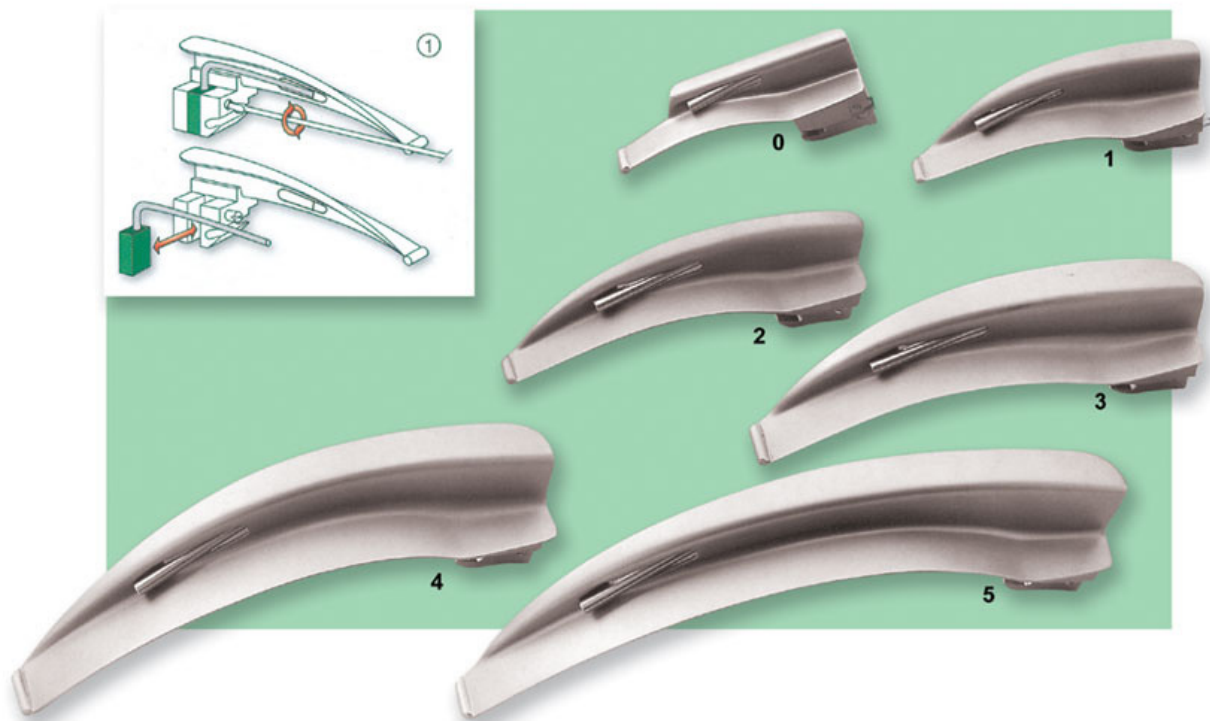

Die Alternative: Statt der Neuanschaffung eines Spatels wechseln Sie im Bedarfsfall lediglich den Lichtleiter aus.



The alternative: Instead of buying a new blade, you only change the light guide, if necessary.

① Einfaches Wechseln des Lichtleiters

① Easy replacement of the light guide

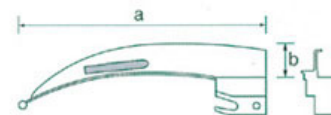

Macintosh

Size	REF	mm
0	0007	79 x 13
1	0008	92 x 18
2	0009	112 x 19
3	0010	133 x 22
4	0011	153 x 21
5	0012	176 x 23

FLAPLIGHT F.O.

Flaplight F.O. Blades

Flaplight F.O. Spatel



Flaplight F.O.

Size	REF	mm
3	0013	130 x 22
4	0014	150 x 25



FlapLight F.O., Macintosh with replaceable fibre-optics. The movable blade tip facilitates lifting of the epiglottis and enables a good visibility at the intubation process even in case of difficult anatomical conditions. An improved visibility and a lower lever action reduce the risk of injury of the larynx and the teeth. The replacement of the fibre-optic light guide cannot be made personally, but the blade has to be returned to **PSI**!

FlapLight case, only, for 2 blades and 1 handle
blades sizes 3 + 4
REF 28 802



FlapLight F.O., Macintosh mit auswechselbarer Fiber Optik. Die bewegliche Spatelspitze erleichtert das Anheben der Epiglottis und ermöglicht auch bei schwierigen anatomischen Verhältnissen die Intubation unter Sicht. Bessere Sicht und weniger Hebelwirkung reduzieren das Verletzungsrisiko für Larynx und Zähne. Das Auswechseln der Fiber Optik kann nicht selbst vorgenommen werden. Der Spatel muss daher an **PSI** eingesandt werden!

FlapLight -Koffer, allein, für 2 Spatel und 1 Griff
Spatel Größe 3 + 4
REF 28 802

Miller blades with *replaceable* fibre-optics
Miller Spatel mit *auswechselbarer* Fiber Optik

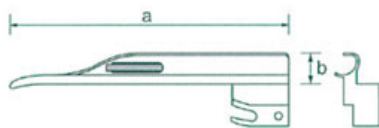

Size	REF	mm
00	0015	65 x 15
0	0016	79 x 13
1	0017	103 x 15
2	0018	156 x 15
3	0019	196 x 22
4	0020	204 x 20

Miller

Laryngoscope handles F.O. 2.5 V with **Xenon** illumination
 Batteriegriffe F.O. 2,5 V mit **Xenon**beleuchtung



*25% more light !
 25% mehr licht !*



Battery/recharging handle, small
 2.5 V (AA) - Mignon
 Ø 19 mm
 REF 0021

Battery/recharging handle, medium
 2.5 V (C) - Baby
 Ø 28 mm
 REF 0022

Battery handle, large
 2.5 V (C) - Baby
 Ø 32 mm
 REF 0023

Battery handle, short
 2.5 V (AA) - Mignon
 Ø 32 mm
 REF 0024



Batterie-/Ladegriff, klein
 2.5 V (AA) - Mignon
 Ø 19 mm
 REF 0021

Batterie-/Ladegriff, mittel
 2,5 V (C) - Baby
 Ø 28 mm
 REF 0022

Batteriegriff, groß
 2,5 V (C) - Baby
 Ø 32 mm
 REF 0023

Batteriegriff, kurz
 2,5 V (AA) - Mignon
 Ø 32 mm
 REF 0024

* Batteries not included in scope of supply !!
 * Batterien nicht im Lieferumfang enthalten !!



Halogen bulb, 2.5 V

Halogenbirne, 2,5 V



Xenon bulb, 2.5 V

Xenonbirne, 2,5 V

Accessories for fibre-optic and conventional laryngoscopes
Zubehör für Fiberoptik- und konventionelle larygoskope



Laryngoscope case only*,
for 3 blades and 1 handle
Macintosh, size 0, 1, 2, 3, 4
Miller, size 00, 0, 1
Foregger, size 0, 1
REF 0025

Laryngoscope case only*,
for 5 blades and 1 handle
Macintosh, size 0, 1, 2, 3, 4
Miller, size 00, 0, 1
Foregger, size 0, 1
REF 0026

Rescue bag only*,
for 4 blades and 1 handle
REF 0027



Laryngoskope-Koffer allein*,
für 3 Spatel und 1 Griff
Macintosh, Größe 0, 1, 2, 3, 4
Miller, Größe 00, 0, 1
Foregger, Größe 0, 1
REF 0025

Laryngoskope-Koffer allein*,
für 5 Spatel und 1 Griff
Macintosh, Größe 0, 1, 2, 3, 4, 5
Miller, Größe 00, 0, 1
Foregger, Größe 0, 1
REF 0026

Notfalltasche allein*,
für 4 Spatel und 1 Griff
REF 0027

FLAPLIGHT C.

Flaplight C. Blades, conventional

Flaplight C. Spatel, konventionell



Flaplight C.

Size	REF	mm
3	0028	130 x 22
4	0029	150 x 25



FlapLight C, Macintosh for difficult anatomical intubations. Quick and efficient work will be guaranteed (see the text of out Flaplight F.O. blades).



FlapLight C, Macintosh für schwierige, anatomische Intubationen. Ein schnelles und effizientes Arbeiten wird garantiert (siehe Flaplight F.O. Spatel).

FlapLight case, only, for 2 blades and 1 handle
blade sizes 3 + 4

FlapLight -Koffer, allein, für 2 Spatel und 1 Griff
Spatel Größe 3 + 4

Conventional laryngoscopes Konventionelle Laryngoskope



Macintosh blades, conventional
Macintosh Spatel, konventionell



PSI provide a versatile range of conventional warmlight laryngoscopes. These instruments are of the same high and robust quality than the fibre-optic programme. The conventional *PSI* laryngoscopes have proved to be extremely reliable, precise and safe in practice for a long time. They guarantee an easy handling and a quick changing of the blade.



PSI bietet ein vielseitiges Sortiment an konventionellen Warmlicht-Laryngoskopen. Dies sind ebenso hochwertige, robuste Qualitätsinstrumente wie das Fiber-optikprogramm. Die Konventionellen *PSI* Laryngoskope haben sich seit langem in der Praxis als äußerst verlässlich, präzise und sicher bewährt. Sie garantieren eine leichte Handhabung und ein schnelles Wechseln der Spatel.

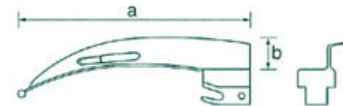

Size	REF	mm
0	0030	80 x 13
1	0031	92 x 18
2	0032	112 x 20
3	0033	133 x 21
4	0034	153 x 21
5	0035	176 x 23

Macintosh

Miller blades, conventional
Miller Spatel, konventionell

Foregger blades, conventional
Foregger Spatel, konventionell

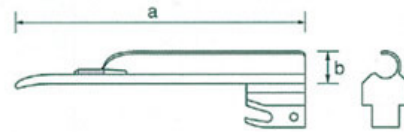
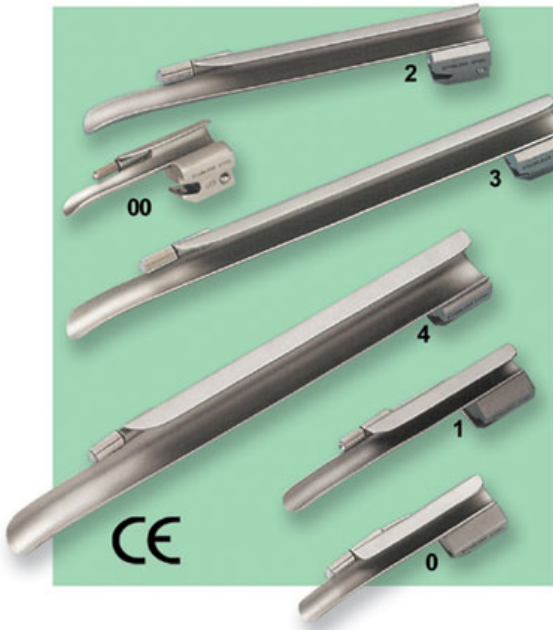

Miller

Size	REF	mm
00	0036	65 x 10
0	0037	79 x 10
1	0038	103 x 10
2	0039	157 x 12
3	0040	196 x 12
4	0041	205 x 16

Foregger

Size	REF	mm
0	0042	77 x 10
1	0043	92 x 12
2	0044	112 x 14
3	0045	132 x 16
4	0046	157 x 18

Polio

Polio **Macintosh** blades, conventional
Polio **Macintosh** spatel, konventionell

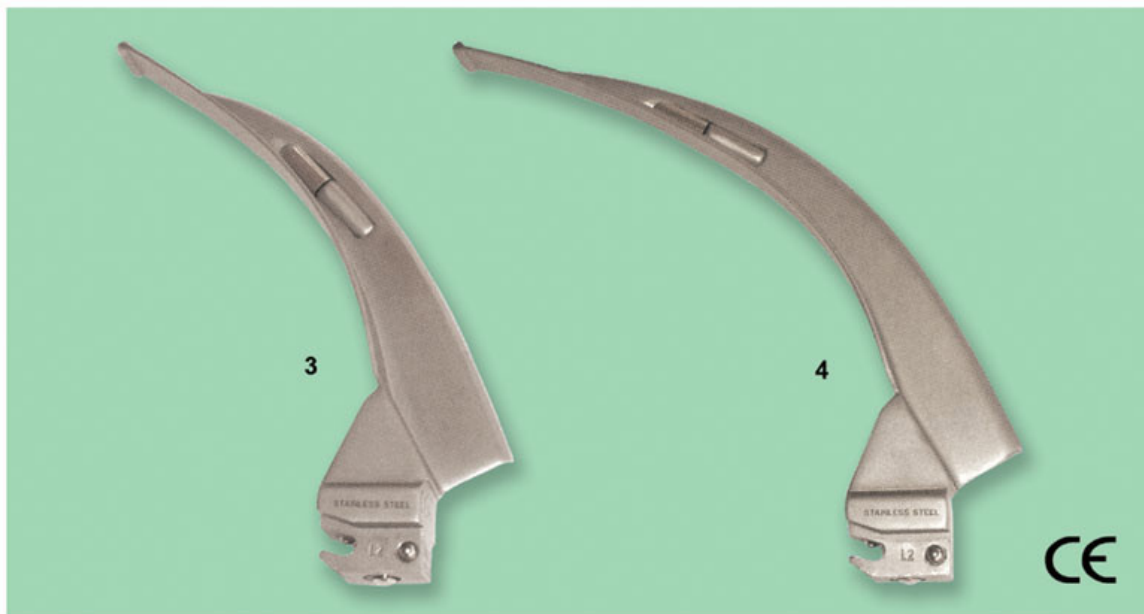

Polio-Macintosh

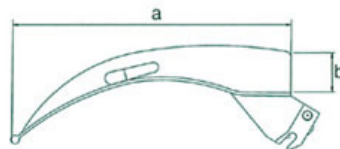

Size	REF	mm
3	0047	130 x 20
4	0048	160 x 20

Foregger blades
with *replaceable* fibre-optics

Foregger Spatel
mit *auswechselbarer* Fiber Optik

Polio Macintosh blades
with *replaceable* fibre-optics

Polio Macintosh Spatel
mit *auswechselbarer* Fiber Optik

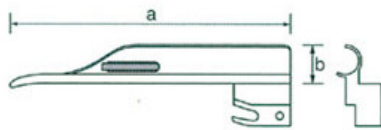

Foregger

Size	REF	mm
0	0049	77 x 13
1	0050	94 x 16
2	0051	113 x 17
3	0052	134 x 22
4	0053	158 x 22

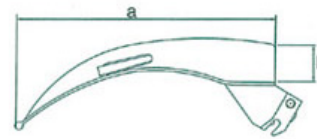

Polio-Macintosh

Size	REF	mm	Replaceable light guide F.O.
3	0054	130 x 20	28 683
4	0055	160 x 20	28 684

ECONOMY



Macintosh blades, conventional
Macintosh spatel, konventionell

Miller blades, conventional
Miller spatel, konventionell

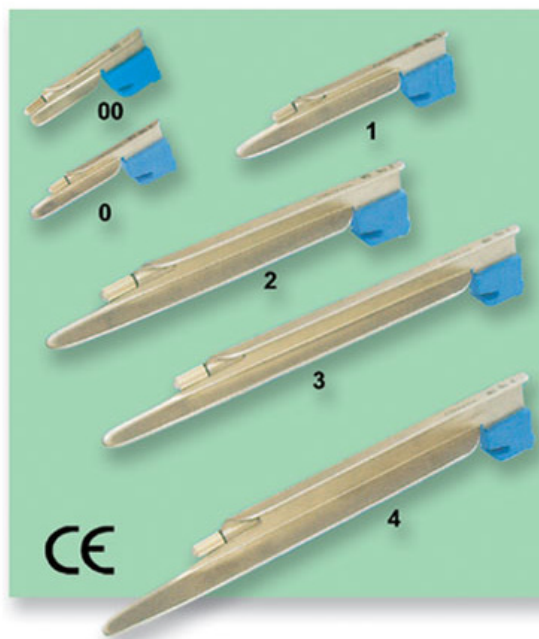
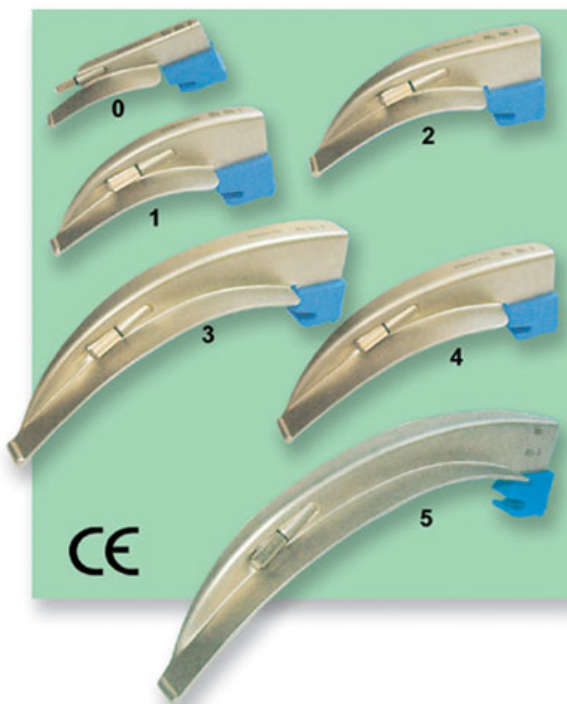

Size	REF	mm
0	0056	80 x 13
1	0057	92 x 18
2	0058	112 x 20
3	0059	133 x 21
4	0060	153 x 21
5	0061	176 x 23

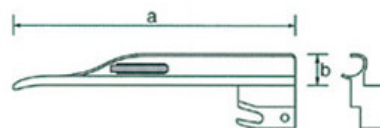

Size	REF	mm
00	0062	65 x 15
0	0063	79 x 13
1	0064	103 x 15
2	0065	156 x 15
3	0066	196 x 22
4	0067	204 x 20

Laryngoscope handles F.O. 3.5 V with **Xenon** illumination
Kaltlicht-Ladegriff F.O. 3,5 V mit **Xenon**beleuchtung



F.O. recharging handle, medium
3.5 V / 240 V, with accumulator (C) rechargeable in the socket
Euro-version
REF 0068

F.O. recharging handle, medium
3.5 V / 120 V, with accumulator (C) rechargeable in the socket
US-version
REF 0069

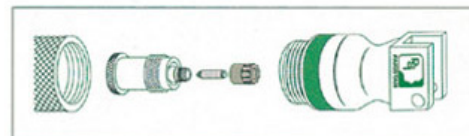

Kaltlicht-/Ladegriff, mittel
3,5 V / 240 V, mit Akku (C) aufladbar in der Steckdose
Euro-Version
REF 0068

Kaltlicht-/Ladegriff, mittel
3,5 V / 120 V, mit Akku (C) aufladbar in der Steckdose
US-Version
REF 0069



Xenon bulb, 3.5 V

Xenonbirne, 3,5 V



Halogen bulb, 3.5 V

Halogenbirne, 3,5 V

Laryngoscope handles, conventional
Batteriegriffe, konventionell



Battery/recharging handle, small
2.5 V (AA) - Mignon
Ø 19 mm
REF 0070

Battery/recharging handle, medium
2.5 V (C) - Baby
Ø 28 mm
REF 0071

Battery handle, large
2.5 V (C) - Baby
Ø 32 mm
REF 0072

Battery handle, short
2.5 V (AA) - Mignon
Ø 32 mm
REF 0073



Batterie-/Ladegriff, klein
2,5 V (AA) - Mignon
Ø 19 mm
REF 0070

Batterie-/Ladegriff, mittel
2,5 V (C) - Baby
Ø 28 mm
REF 0071

Batteriegriff, groß
2,5 V (C) - Baby
Ø 32 mm
REF 0072

Batteriegriff, kurz
2,5 V (AA) - Mignon
Ø 32 mm
REF 0073

* Batteries not included in scope of supply !!
* Batterien nicht im Lieferumfang enthalten !!

Compatible



Kompatibel



Krypton bulb, small,
2.5V,
for blade sizes no. 00, 0, 1

Kryptonbirne, klein
2,5 V,
für Spatelgröße 00, 0, 1

Krypton bulb, large,
2.5V,
for blade sizes no. 2, 3, 4, 5

Kryptonbirne, große
2,5 V,
für Spatelgröße 2, 3, 4, 5

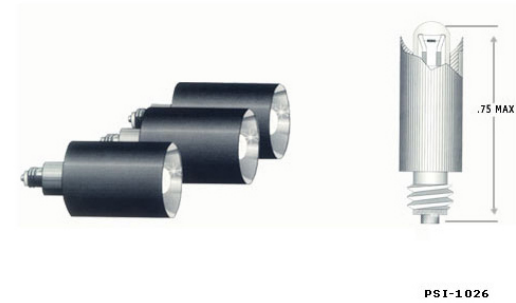
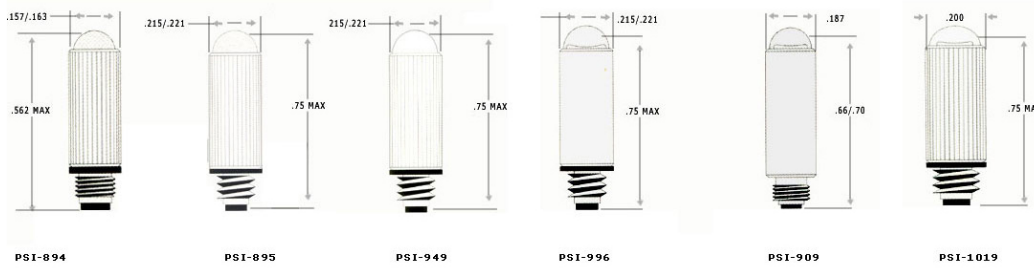

PSI Conventional Vacuum Medical Lamps

Fiberoptic Medical Lamps

PSI-894 Frosted, PSI-904 Clear, 1-8 72NS3 Thread 2.5V .28A 20 Hour Life, Nickel Plated Vacuum, T-

PSI Conventional Vacuum Medical Lamps

Fiberoptic Medical Lamps

PSI-996, 8-32 UNC 2A Thread 2.5V .35A 15 Hour, Life Nickel Plated Vacuum, TL-1 1/2 Lamp, PSI-909,

PSI Conventional Vacuum Medical Lamps

Fiberoptic Medical Lamps

PSI-1026, Mediflector 8-32 UNC 2A Thread 2.5V .30A 15 Hour Life Nickel Plated Vacuum TL-1 1/4 Lam

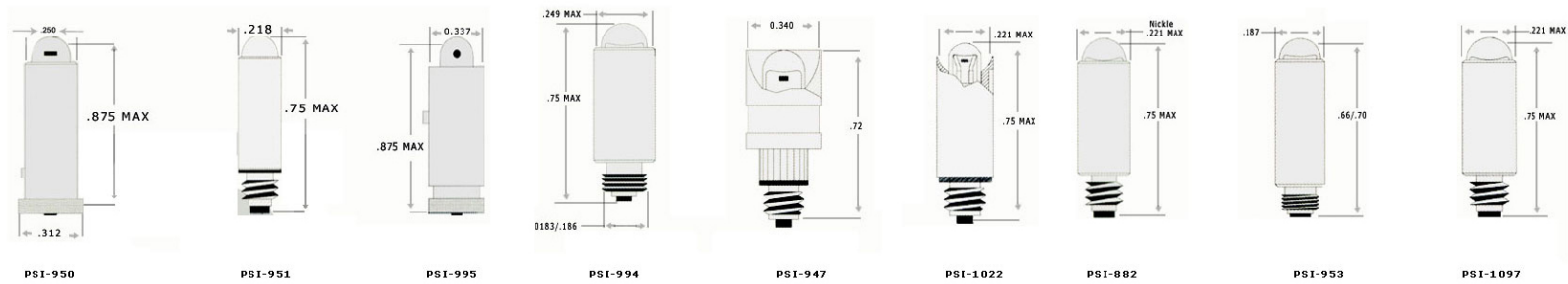

PSI Fiberoptic Gas Filled Medical Lamps
Fiberoptic Medical Lamps

PSI-950, 3.5V .7A 15 Hour Life Nickel Plated Xenon Filled T-1 1/2 Lamps, PSI-951, 10-32 thread 2.

PSI Fiberoptic Gas Filled Medical Lamps
Fiberoptic Medical Lamps

PSI-994, 48 Grooves Per inch 3.5V .72A 20 Hour Life Nickel Plated Xenon Filled TL-1 1/2 Lamp, PSI

PSI Fiberoptic Gas Filled Medical Lamps
Fiberoptic Medical Lamps

PSI-882 & Gold, PSI-883 Nicke, 8-32 UNC 2A thread 2.7V .70A 20 Hour Life(PSI-882/883) 3.5v .7



Metal Body, Fiber Optic (2.5 V)..

Diagnostic Set + Ophthalmoscope Set

PSI-220, Ophthalmoscope & Otoscope Head, Nasal Specula, Dental Mirror,
Reusable Specula, L Pi



Plastic Body Mini Ophthalmoscopes

Diagnostic Set + Ophthalmoscope Set

PSI-221 Black, PSI-222 Blue, PSI-223 Green, PSI-224 Red, PSI
Ophthalmoscopes with superior aspher



Heavy Duty Tongue Depressor Holder

Pen Torch

PSI-224 Black, PSI-225 Blue, PSI-226 Green, PSI-227 Red, This Heavy Duty
Tongue Depressor Holder



Heavy Duty Pen Torch

Pen Torch

This is Heavy Duty Pen Torch All purpose illuminator. Supplied in Soft
Fabric Case.



Soft Packing & Box

Soft Packing & Box

PSI-234 Metal Otoscope Leather Case

PSI-235 Mini Otoscope Soft Case

PSI-236 Ophthalgo



Disposable Spatulas For Otoscopes

Reusable Tips for Otoscopes

PSI-232 ..Size: 4mm

PSI-233 ..Size: 2.8mm



PSI-STETHOSCOPE, DUAL HEAD

PSI-01-101

PSI-STETHOSCOPE, DUAL HEAD

Stethoscope, dual head, 1 ea.

Spectrum® dual head stethoscope:<



PSI-SPRAGUE STETHOSCOPE

PSI-01-102

Features dual 22" PVC tubing for clear

sound transmission and threaded soft

ear tips.

Red



**PSI-Sprague Rappaport Type
Stethoscope**

PSI-01-103

A) Silver color head, transparent tube

accessories and replacement parts



**PSI-Sprague Rappaport Type
Stethoscope**

PSI-01-104

B) Comes complete with a clear multi - pocket bag for

relevant

accessories and replacement parts



Buck

PSI-1-101-18

Percussion Hammer

18.5 cm



Buck

PSI-1-102-18

20cm

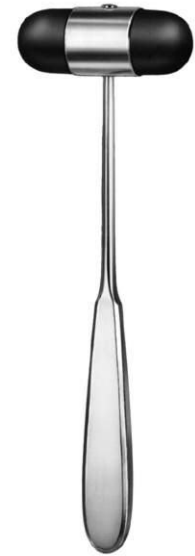

Dejerine

PSI-1-103-20

Percussion Hammer

20cm



Dejerine

PSI-1-104-21

Percussion Hammer

21cm



Taylor Mod. USA

PSI-1-105-20

Percussion Hammer

20cm



Wartenberg

PSI-1-106-19

Pinwheel

18 cm



Pinard

PSI-1-107-18

Stethoscope

18 cm



Pinard

PSI-1-108-15

Stethoscope

15cm



Magill

PSI-2-101-15

Catheter Introducing Forceps
14.5 cm, 20 cm, 25 cm



Miller

PSI-1-101-18

Laryngoscope Sets



Miller-Baby

PSI-2-103-00

Laryngoscope Sets



Miller

PSI-2-104-00

Laryngoscope Blade
Fig. 0, Fig. 1, Fig. 2, Fig. 3, Fig. 4



Guedel-Negus

PSI-2-105-00

Laryngoscope Sets
Fig. 2, Fig. 3, Fig. 4



Guedel-Negus

PSI-2-106-00

Laryngoscope Sets
Fig. 1, Fig. 2, Fig. 3, Fig. 4



Guedel-Negus

PSI-2-107-01

Laryngoscope Blades
Fig. 1, Fig. 2, Fig. 3, Fig. 4



McIntosh

PSI-2-108-00

McIntosh



McIntosh

PSI-2-109-0

Laryngoscope Blades
Fig. 0, Fig. 1, Fig. 2, Fig. 3, Fig. 4



McIntosh

PSI-2-110-00

Laryngoscope Sets
Fig. 1, Fig. 2, Fig. 3, Fig. 4



Foregger

PSI-2-111-01

Laryngoscope Blades
Fig. 1, Fig. 2, Fig. 3, Fig. 4



Battery Handle

PSI-2-112-00

Battery Handle



McIntosh

PSI-2-114-00

Laryngoscope Sets fiber optic

Fig. 1, Fig. 2, Fig. 3



McIntosh

PSI-2-115-00

Laryngoscope Sets fiber optic

Fig. 1, Fig. 2, Fig. 3



McIntosh

PSI-2-116-00

Laryngoscope Sets fiber optic

Fig. 1, Fig. 2, Fig. 3



McIntosh

PSI-2-113-00

Laryngoscope Sets

Fig. 1, Fig. 2, Fig. 3, Fig. 4



Universal

PSI-3-101-04

Trocar
14 cm



Nelson

PSI-3-102-07

Trocar
20cm



Lichtwitz

PSI-3-103-19

Antrum Trocar
18.5 cm



Adson

PSI-3-104-21

Suction Cannula
20cm



Frazier

PSI-3-105-10

Suction Cannula
24 cm



Frazier

PSI-3-106-06

Suction Cannula
19.5 cm



Poppen

PSI-3-107-06

Suction Cannula
18 cm



Luer

PSI-3-108-30

Suction Tube working length 110 mm



Yasargil

PSI-3-109-15

Suction Tube working length 150 mm with Luer
hub



Yankauer

PSI-3-110-27

Suction Tube complete with suction tip and
connector
31 cm



Yankauer

PSI-3-111-00

Suction Tube
31 cm , 15 cm, 2.5 cm, 10 cm



Poole

PSI-3-112-22

Suction Tube
22cm



Poole
PSI-3-113-22
Suction Tube
22.5 cm



Nuboer
PSI-3-114-21
Suction Tube
21cm



Nuboer
PSI-3-115-21
Suction Tube
21cm



Quinke
PSI-3-116-10
Lumbar Puncture Needle



Tuohy
PSI-3-117-12
Lumbar Puncture Needle Luer Lock connection
with special tip



Verres
PSI-3-118-20
Insufflation Cannula Luer Lock connection
15 cm



Verres

PSI-3-119-20

Insufflation Cannula Luer Lock connection

17 cm



Kalt

PSI-4-105-14

Needle Holder

13.5 cm



Barraquer-Troutman

PSI-4-106-10

Micro Needle Holder

10 cm , 10.5 cm



Arruga

PSI-4-107-14

Micro Needle Holder

13.5 cm



Barraquer-Troutman

PSI-4-108-10

Micro Needle Holder

10.5 cm , 11.5cm



Barraquer

PSI-4-109-11

Micro Needle Holder

11.5cm, 13.5 cm , 14 cm



Barraquer

PSI-4-110-13

Micro Needle Holder

13.5 cm



Castroviejo-Fino

PSI-4-111-01

Micro Needle Holder

13cm



Castroviejo-Fino

PSI-4-112-01

Micro Needle Holder

13cm



Castroviejo-Fino

PSI-4-113-01

very delicate jaw with lock

13cm



Castroviejo

PSI-4-114-14

Micro Needle Holde

Fig.65, Fig.69, Fig.88 L, 14 cm



Castroviejo

PSI-4-115-14

Micro Needle Holde

14 cm



Castroviejo

PSI-4-121-14

Micro Needle Holde

14 cm



Castroviejo

PSI-4-122-14

Micro Needle Holder

14 cm



Castroviejo

PSI-4-124-13

Micro Needle Holder with lock

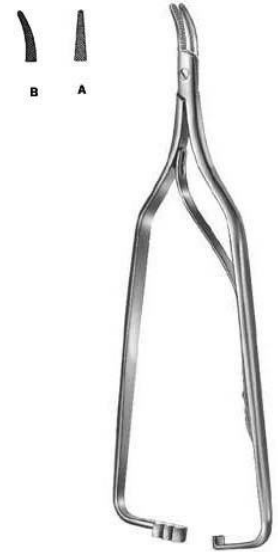

Arruga

PSI-4-123-16

Needle Holder delicate

16 cm



Castroviejo

PSI-4-125-12

Micro Needle Holder with lock

12 cm



Derf

PSI-4-126-12

Needle Holder

12 cm, 13cm

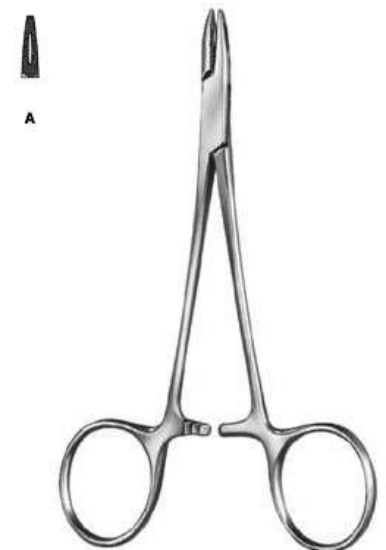

Collier

PSI-4-127-12

Needle Holder

12.5 cm



Webster

PSI-4-128-13

Needle Holder

13cm



Halsey

PSI-4-129-13

Needle Holder

13.5 cm

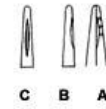

Neivert

PSI-4-130-13

Neivert

12.5 cm



Metzenbaum

PSI-4-141-18

Needle Holder one grooved and fenestrated jaw

18.5 cm



M. G. Hospital

PSI-4-142-17

Needle Holder

17.5 cm



Mayo-Hegar

PSI-4-143-14

Needle Holder

14.5 cm , 16 cm , 18.5 cm , 24 cm



Adson

PSI-4-140-18

Needle Holder one fenestrated jaw
18 cm



Metzenbaum

PSI-4-141-18

Needle Holder one grooved and fenestrated jaw
18.5 cm



M. G. Hospital

PSI-4-142-17

Needle Holder
17.5 cm

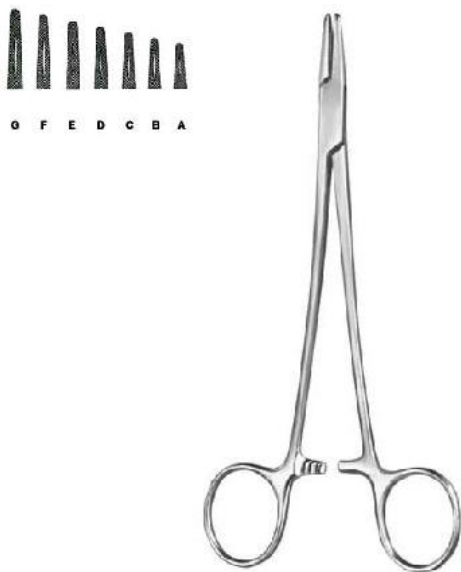

Mayo-Hegar

PSI-4-143-14

Needle Holder

14.5 cm , 16 cm , 18.5 cm , 20.5 cm , 24 cm , 26.5 cm

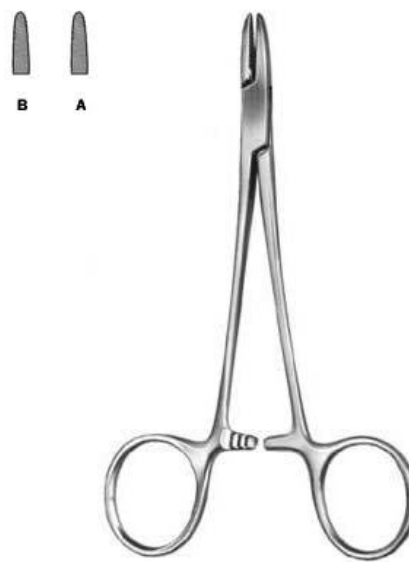

Brown

PSI-4-145-13

Needle Holder

13cm, 18 cm



Mayo Hegar

PSI-4-144-16

Needle Holder

16 cm , 18.5 cm , 20.5 cm

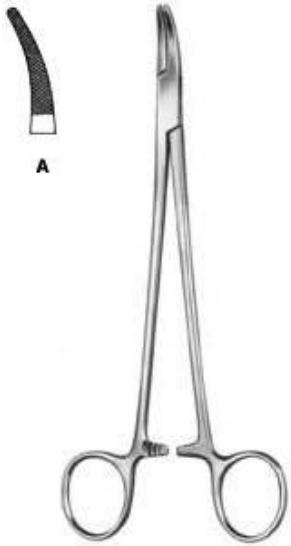

Heaney
PSI-4-146-21
Needle Holder
20.5 cm

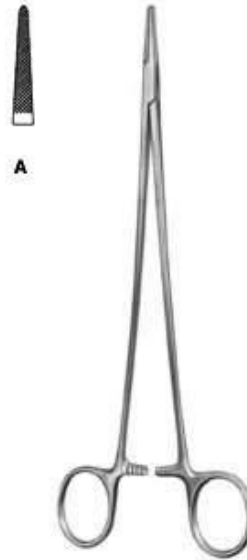

Jamison
PSI-4-147-23
Needle Holder
23.5 cm



Masson
PSI-4-148-27
Needle Holder
26.5 cm

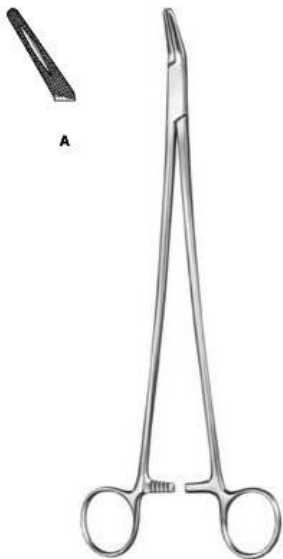

Finochietto
PSI-4-149-27
Needle Holder
26.5 cm



Wangensteen
PSI-4-150-27
Needle Holder
26.5 cm

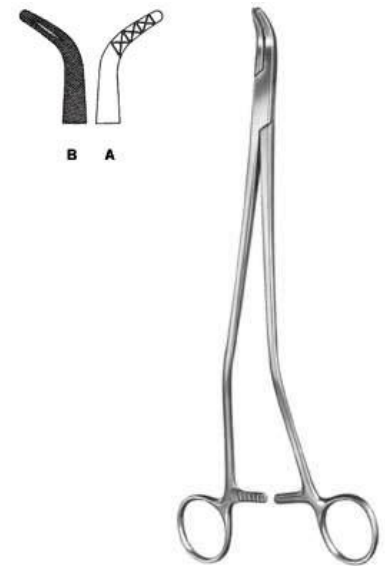

Johnson
PSI-4-151-27
Needle Holder
27 cm

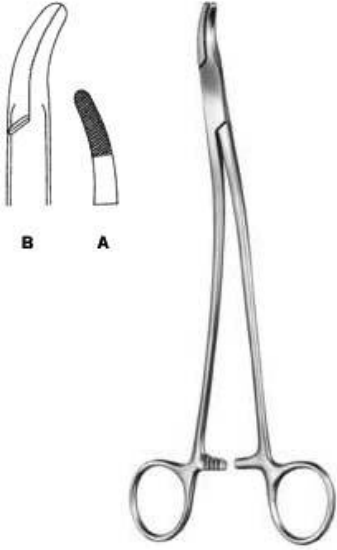

Stratte

PSI-4-152-23

Needle Holder

23 cm

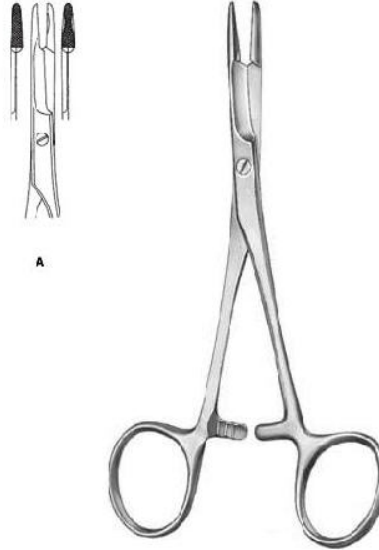

Olsen-Hegar

PSI-4-153-14

Needle Holder

14 cm

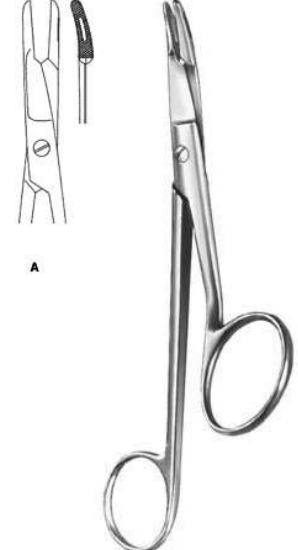

Gillies

PSI-4-154-16

Needle Holder

16 cm



Crile

PSI--155-15

Needle Holder

15 cm



Mathieu

PSI-4-156-14

Needle Holder

14 cm, 17 cm , 20cm



Mathieu

PSI-4-157-14

Needle Holder

16.5 cm



Toennis

PSI-4-158-18

Needle Holder

18.5 cm



Lichtenberg

PSI-4-159-20

Needle Holder

20cm



Micro Needle Holder

PSI-4-160-16

Micro Needle Holder

16 cm

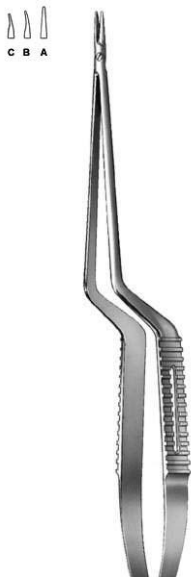

Micro Needle Holder

PSI-4-161

Micro Needle Holder

19 cm



Hepp-Scheidel

PSI-4-162-18

Micro Needle Holder smooth jaw

18 cm

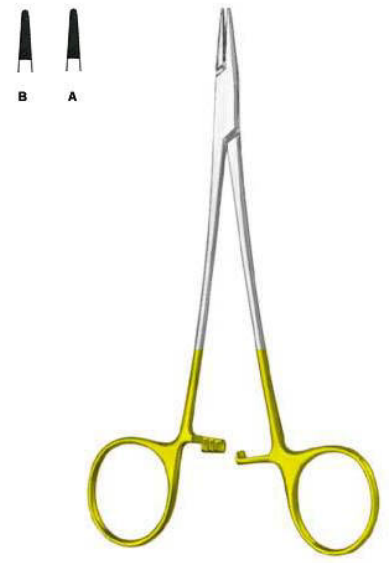

Webster

PSI-4-163-13

Needle Holder with automatic release ratchet
also for lefthanders

Fig.233, 16 cm , 12 cm , 13cm, 15 cm



Micro Needle Holder

PSI-4-164-15

Micro Needle Holder
15 cm, 18 cm, 21cm, 23 cm



JABOMA

PSI-4-165-18

Micro Needle Holder
18 cm



Castroviejo

PSI-4-166

Micro Needle Holder
Fig.233, 16 cm , 12 cm, Fig.18 L, 14.5 cm , 18 cm,
21cm



Arruga

PSI-4-167

Needle Holder
Fig.233, 16 cm , 12 cm, Fig.18 L, 16 cm



Castroviejo

PSI-4-168-13

Micro Needle Holder
12.5 cm



Barraquer

PSI-4-169-13

13 cm



Barraquer

PSI-4-170-13

Micro Needle Holder

13 cm



Webster

PSI-4-171-13

Needle Holder

13 cm



Derf

PSI-4-173-12

Needle Holder

12 cm

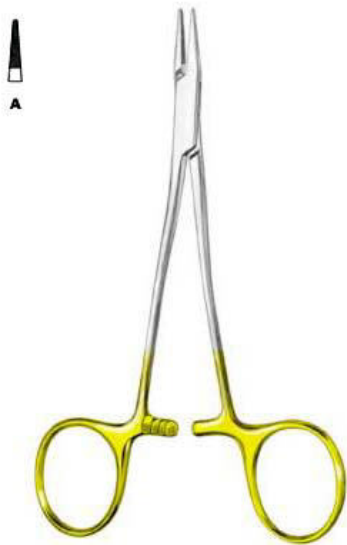

Kilner

PSI-4-172-13

13 cm



Hegar-Baumgartner

PSI-4-174-13

Needle Holder

13 cm , 14.5 cm



Halsey

PSI-4-175-12

Needle Holder

13 cm , 12 cm



Crile-Wood

PSI-4-176-15

Needle Holder
15 cm



Sarot

PSI-4-177-18

Needle Holder
18 cm, 20 cm, 26 cm

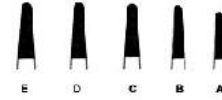

Mayo-Hegar

PSI-4-178-16

Needle Holder standard profile
16 cm, 18 cm, 20 cm, 24 cm, 26 cm, 30 cm



Heaney

PSI-4-179-20

Needle Holder
20 cm, 24 cm, 26 cm

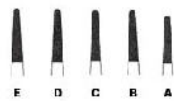

DeBakey

PSI-4-180-18

Needle Holder delicate pattern mini profile
18 cm, 20 cm, 23 cm, 26 cm, 31 cm



Masson

PSI-4-181-27

Needle Holder
26.5 cm



Ryder (Martin)

PSI-4-182-13

Needle Holder

12.5 cm, 15 cm, 18 cm, 20 cm, 23 cm, 26 cm



Martin

PSI-4-183-15

Needle Holder mini profile elastic type

15 cm, 17 cm, 20 cm



Wangensteen

PSI-4-184-27

Needle Holder standard profile

27 cm



Hegar-Vascular

PSI-4-185-14

Needle Holder micro profile

14 cm, 18.5 cm, 20.5 cm, 23 cm

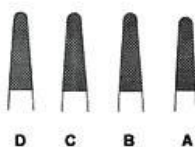

Bozemann

PSI-4-186-20

Needle Holder standard profile

20.5 cm, 24 cm, 26.5 cm, 29 cm



Hegar

PSI-4-187-20

Needle Holder standard profile

20 cm, 23.5 cm



Stratte

PSI-4-188-22

Needle Holder standard profile
23 cm

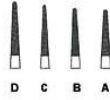

Microvascular

PSI-4-189-00

Needle Holder slender pattern micro profile
14 cm, 17.5 cm, 20 cm, 23 cm



Mathieu

PSI-4-190-14

Needle Holder
14 cm, 17 cm, 20 cm



Mathieu

PSI-4-191-14

Needle Holder
14 cm, 17 cm, 20 cm



Mathieu

PSI-4-192-17

Needle Holder standard profile with interior
ratchet
17 cm, 20 cm, 23 cm



Toennis

PSI-4-193-18

Needle Holder
18.5 cm



Lichtenberg
PSI-4-194-20

Needle Holder lightweight model standard profile
20 cm



Langenbeck
PSI-4-195-18

Needle Holder
18 cm, 20.5 cm, 23 cm



Zweifel
PSI-4-196-20

Needle Holder with hinged ratchet standard
profile
20.5 cm, 23 cm



Reverdin
PSI-4-197-15

Reverdin Needle short
14 cm Fig. 1, 14 cm Fig. 2, 14 cm Fig. 3, 14 cm
Fig. 4

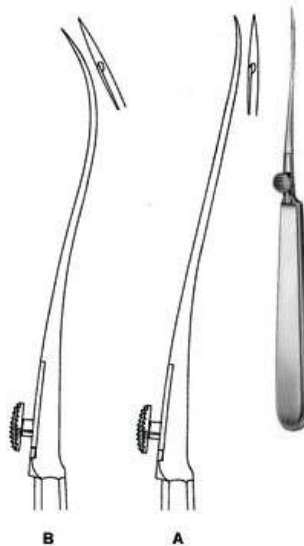

Reverdin
PSI-4-198-19

Reverdin Needle medium
19.5 cm Fig. 1, 19.5 cm Fig. 2, 19.5 cm Fig. 3, 19.5
cm Fig. 4

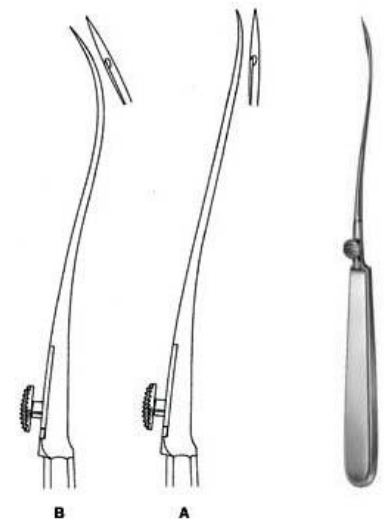

Reverdin
PSI-4-199-23

Reverdin Needle long
23 cm Fig. 1, 23 cm Fig. 2, 23 cm Fig. 3, 23 cm Fig.
4

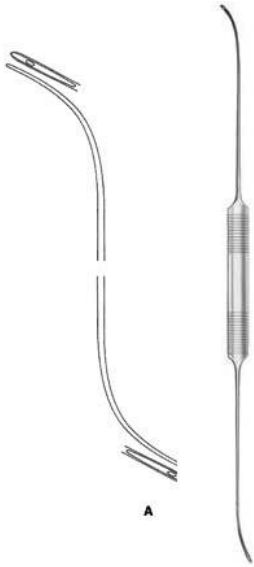

Schmieden-Dick

PSI-4-201-01

Ligature Needle malleable
29 cm

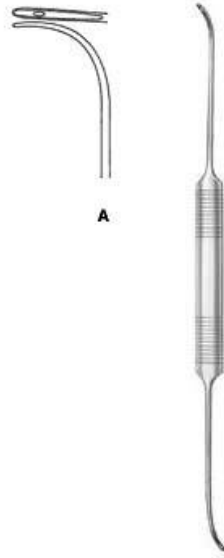

Schmieden

PSI-4-202-21

Ligature Needle
24 cm



Ligature Needle Malleable

PSI-4-203-20

Ligature Needle malleable
20.5 cm

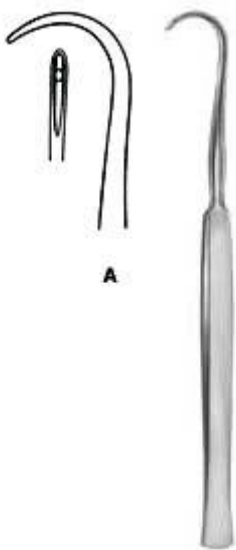

Cooper

PSI-4-204-19

Ligature Needle
18.5 cm



Kronecker

PSI-4-205-13

Ligature Needle delicate for right hand
12.5 cm

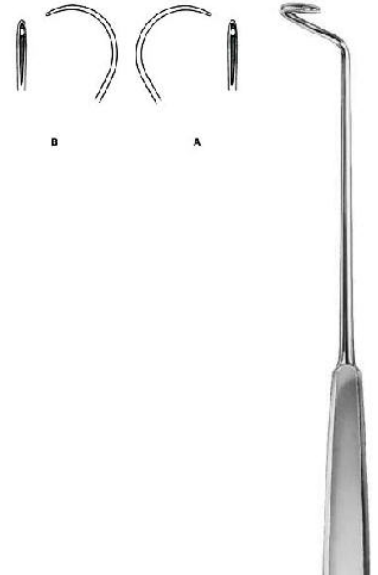

Deschamps

PSI-4-206-24

24 cm

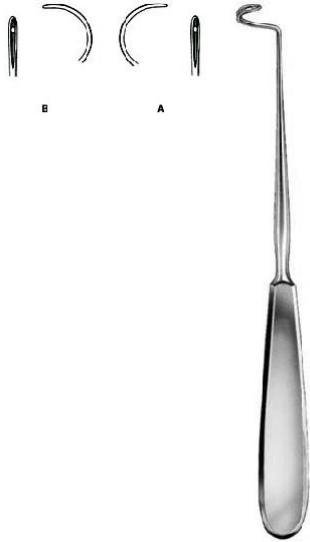

Deschamps

PSI-4-207-20

Ligature Needle blunt for right hand
20 cm

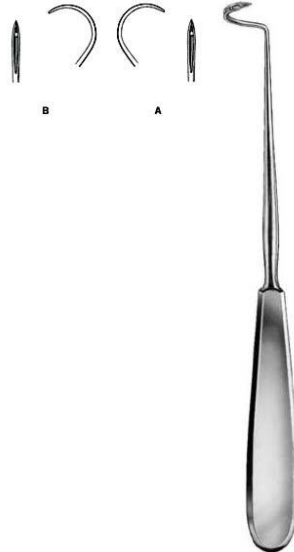

Deschamps

PSI-4-208-20

Ligature Needle sharp for right hand
20 cm

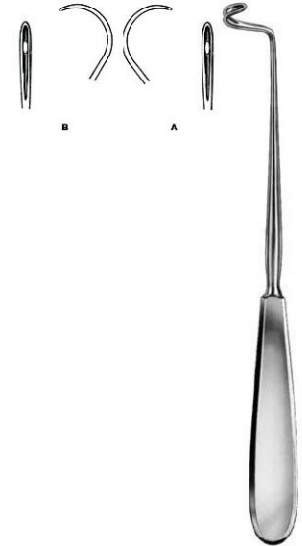

Deschamps

PSI-4-209-21

Ligature Needle blunt for right hand
20 cm

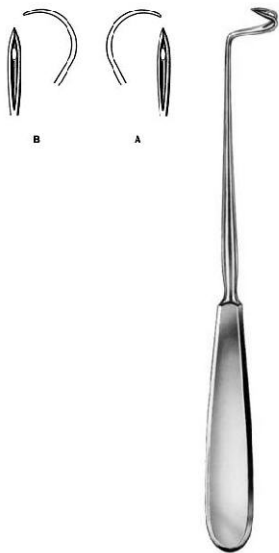

Deschamps

PSI-4-210-21

Ligature Needle sharp for right hand
20 cm

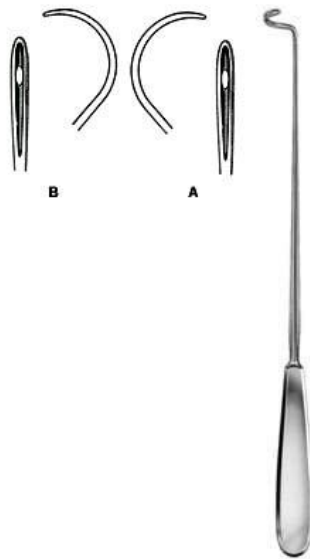

Deschamps

PSI-4-211-27

Ligature Needle blunt for right hand
27 cm

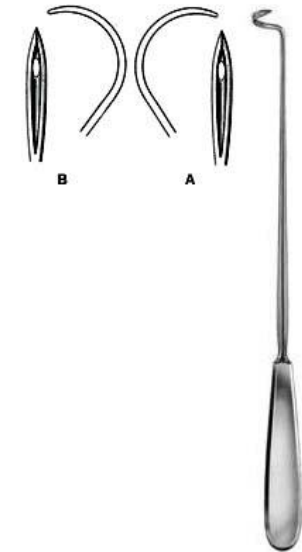

Deschamps

PSI-4-212-27

Ligature Needle sharp for right hand
27 cm

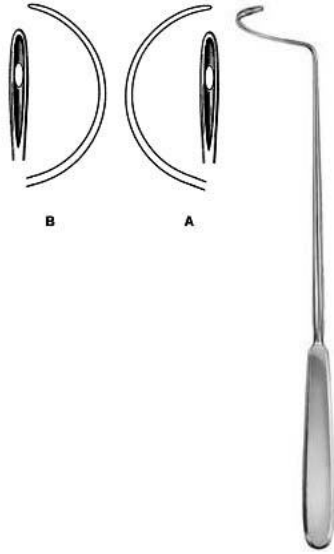

Deschamps

PSI-4-213-28

28 cm

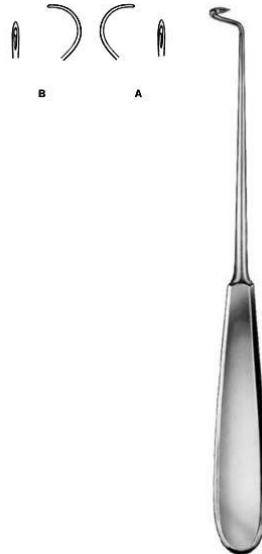

Deschamps

PSI-4-214-20

Ligature Needle sharp for right hand

20 cm



Deschamps

PSI-4-215-20

Ligature Needle blunt for right hand

20 cm



Deschamps

PSI-4-216-20

Ligature Needle blunt for right hand

21 cm

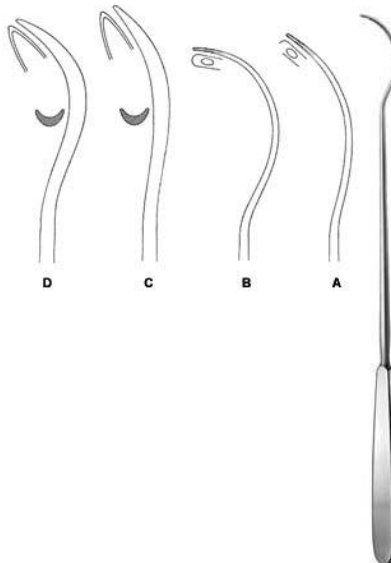

Brunner

PSI-4-217-30

Ligature Needle

21 cm



Kirschner

PSI-4-218-25

Ligature Conductor

25.5 cm

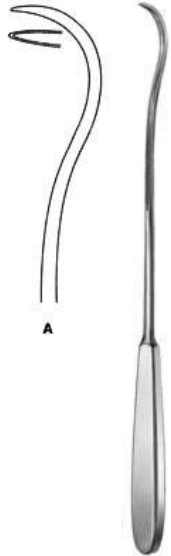

Ligature Conductor

PSI-4-219-28

Ligature Conductor
28 cm



Modell Wien

PSI-4-220-23

Ligature Catcher
23.5 cm



Michel

PSI-4-221-12

Clip Applying Forceps
12 cm



Hegenbarth

PSI-4-222-12

Clip Applying Forceps
12 cm



Dissecting Knife

PSI-5-101-01

D

15 cm, 15.5 cm, 16 cm, 17 cm



Autopsy Knife

PSI-5-102-10

A

25.5 cm

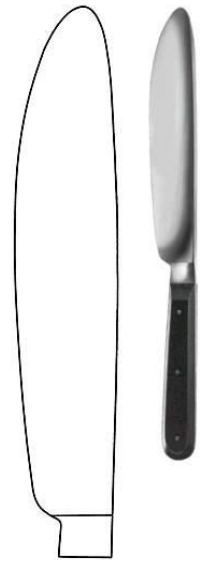

Walb

PSI-5-104-17

Post Mortem Knife<

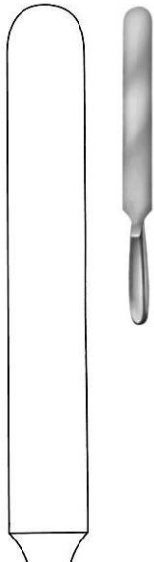

Virchow

PSI-5-105-20

28.5 cm, 33.5 cm, 38 cm



Scalpel Handle

PSI-5-108-04

Scalpel Handle

13.5 cm



Scalpel Handle

PSI-5-109-34

Scalpel Handle

16 cm



Scalpel Handle

PSI-5-110-41

Scalpel Handle

21cm



Scalpel Handle

PSI-5-111-45

Scalpel Handle

21cm



Collin

PSI-5-112-08

Scalpel Handle wit

13.5 cm



Collin

PSI-5-113-09

S

14.5 cm



Scalpel Handle

PSI-5-114-03

S

12 cm



Scalpel Handle

PSI-5-115-04

S

12 cm



Scalpel Handle

PSI-5-116-05

S

12 cm



Scalpel Handle

PSI-5-117-31

S

21.5 cm



Scalpel Handle

PSI-5-118-35

S

21cm



Scalpel Handle

PSI-5-119-07

S

16 cm



Scalpel Handle

PSI-5-120-71

S

12.5 cm



Scalpel Handle

PSI-5-121-03

S

15.5 cm



Amputation Knife

PSI-5-127-16

A
29 cm



Amputation Knife

PSI-5-128-19

A
32.5 cm



Catlin

PSI-5-129-16

I
29 cm



Resection Knife

PSI-5-130-06

R
18 cm



Langenbeck

PSI-5-131-05

R
18 cm



Langenbeck

PSI-5-132-05

18 cm



Standard BL / BL Straight

PSI-5-201-13

Operating Scissor Special Price: \$1.25

12 cm, 13cm, 14.5 cm , 16.5 cm , 18.5 cm , 20.5 cm



Standard SH / BL STR

PSI-5-202-13

Operating Scissors

12 cm, 13cm, 14.5 cm , 16.5 cm, 18.5 cm , 20.5 cm



Standard SH / SH STR

PSI-5-204-13

Operating Scissors

12 cm, 13cm, 14.5 cm , 16.5 cm



Standard BL / BL Curved

PSI-5-205-13

Operating Scissors

12 cm, 13cm, 14.5 cm , 16.5 cm, 18.5 cm , 20.5 cm

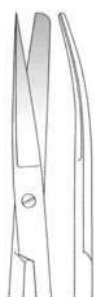

Standard SH / BL Curved

PSI-5-206-13

Operating Scissors

12 cm, 13cm, 14.5 cm , 16.5 cm, 18.5 cm , 20.5 cm

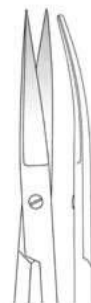

Standard SH / SH Curved

PSI-5-207-13

Operating Scissors

12 cm, 13cm, 14.5 cm , 16.5 cm



Standard BL / BL Curved

PSI-5-208-14

Operating Scissors delicate
14.5 cm



Incision Scissor

PSI-5-209-14

Operating Scissor
14.5 cm



Deaver

PSI-5-210-14

Operating Scissor



Mayo

PSI-5-211-15

Dissecting Scissors
14.5 cm , 15 cm , 17 cm , 23.5 cm



Mayo

PSI-5-212-23

Dissecting Scissors
23 cm , 22.5 cm , 28 cm



Mayo-Harrington

PSI-5-213-22

Dissecting Scissors
23 cm , 22.5 cm , 28 cm

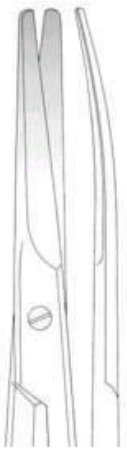

Mayo-Harrington

PSI-5-214-22

Dissecting Scissors cur
22.5 cm, 23 cm, 28 cm



Mayo-Stille

PSI-5-215-17

Dissecting Scissors str
15 cm, 17 cm



Mayo-Stille

PSI-5-216-15

Dissecting Scissors cur
15 cm, 17 cm



Mayo-Stille

PSI-5-217-19

Dissecting Scissors cur
16 cm, 19.5 cm, 21.5 cm



Mayo-Stille

PSI-5-218-16

Dissecting Scissors cur
16 cm, 19.5 cm, 21.5 cm



Mayo-Noble

PSI-5-219-17

Gynecological Scissors
16.5 cm

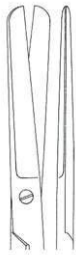

Sims

PSI-5-220-23

Gynecological Scissors str
20cm, 23 cm

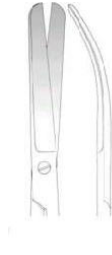

Sims

PSI-5-221-20

Gynecological Scissors cur
20cm, 23 cm



Kelly

PSI-5-222-16

Operating Scissors
16 cm



Doyen

PSI-5-223-17

Gynecological Scissors
18.5 cm



Sims-Siebold

PSI-5-224-24

24.5 cm



Sims-Siebold

PSI-5-225-24

Gynecological Scissors
24.5 cm



Wertheim

PSI-5-226-23

Gynecological Scissors
20cm, 23 cm



Metzenbaum

PSI-5-227-11

Dissecting Scissors
11



Metzenbaum

PSI-5-228-14

Dissecting Scissors
14.5 cm



Metzenbaum

PSI-5-229-15

Dissecting Scissors
15.5 cm



Metzenbaum-Nelson

PSI-5-230-20

Dissecting Scissors
18 cm, 20.5 cm, 23 cm , 26 cm, 28.5 cm, 31 cm



Metzenbaum-Nelson

PSI-5-231-20

Dissecting Scissors
18 cm, 20.5 cm



Metzenbaum-Nelson

PSI-5-232-20

Dissecting Scissors

18 cm, 20.5 cm, 23 cm, 26 cm, 28.5 cm, 31 cm



Metzenbaum

PSI-5-233-14

Dissecting Scissors toothed

14.5 cm



Nerve Operating Scissor

PSI-5-234-15

Dissecting Scissors

15.5 cm

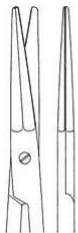

Gorney

PSI-5-235-19

Face-lift Scissors str

12.5 cm, 19.5 cm



Gorney

PSI-5-236-19

Face-lift Scissors cur

19.5 cm



Aston

PSI-5-237-17

Face-lift Scissors

17 cm



Lexer

PSI-5-238-16

Dissecting Scissors
16 cm



Cinelli

PSI-5-239-14

Nasal Scissors
11.5cm, 14 cm



Thorek

PSI-5-240-19

Dissecting Scissors
18.5 cm



Lexer-Baby

PSI-5-241-10

Dissecting Scissors
10 cm



Lexer-Fino

PSI-5-242-16

Delicate Dissecting Scissors slender pattern
16.5 cm



Metzenbaum-Fino

PSI-5-243-14

Delicate Dissecting Scissors slender pattern
14.5 cm





Metzenbaum-Fino

PSI-5-244-14

Delicate Dissecting Scissors
14.5 cm



Metzenbaum-Fino

PSI-5-245-14

Delicate Dissecting Scissors
14.5 cm



Metzenbaum-Fino

PSI-5-246-14

Delicate Dissecting Scissors
14.5 cm

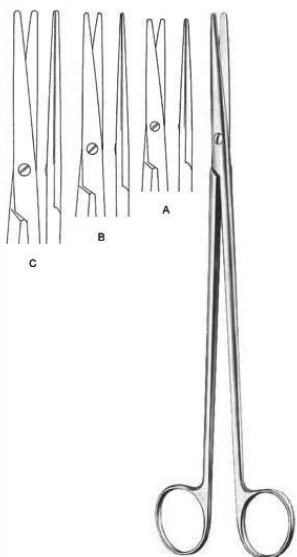

Metzenbaum-Fino

PSI-5-247-18

Delicate Dissecting Scissors slender pattern
18 cm, 20cm, 23 cm

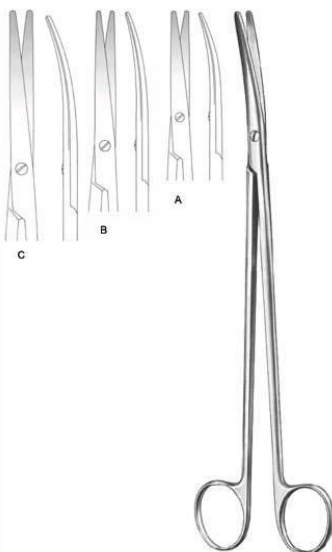

Metzenbaum-Fino

PSI-5-248-18

Delicate Dissecting Scissors slender pattern
18 cm, 20cm, 23 cm

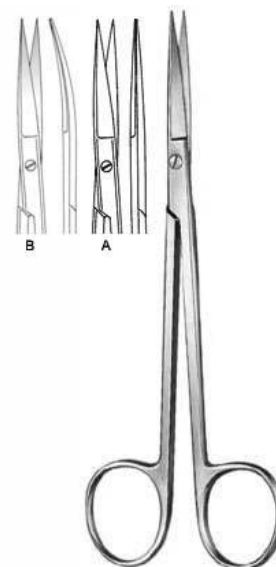

Sanvenero

PSI-5-250-14

Operating Scissors
14 cm

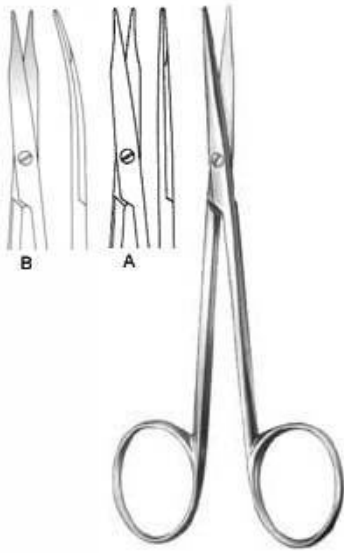

Fine Operating Scissors

PSI-5-251-11

Fine Operating Scissors
11.5cm

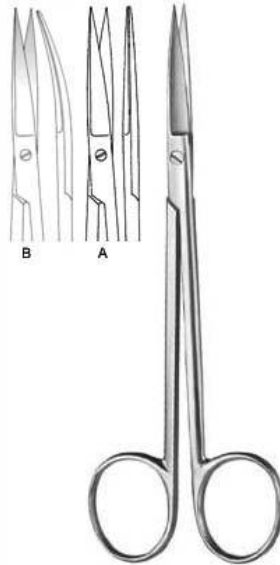

Joseph

PSI-5-252-14

Operating Scissors
14.5 cm

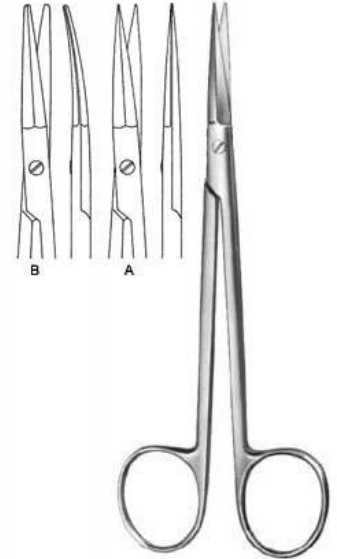

Peck-Joseph

PSI-5-253-14

Face-lift Scissors
14.5 cm

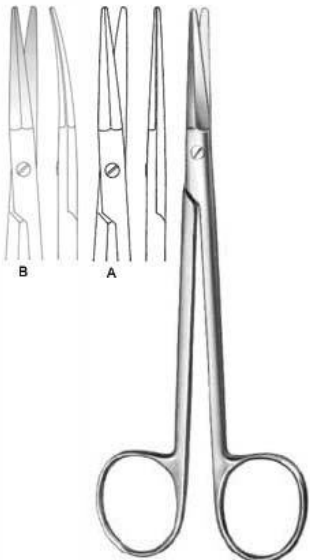

Peck-Joseph

PSI-5-254-14

Face-lift Scissors
14.5 cm



Shea Vein Graft

PSI-5-255-12

Dissecting Scissors
12 cm

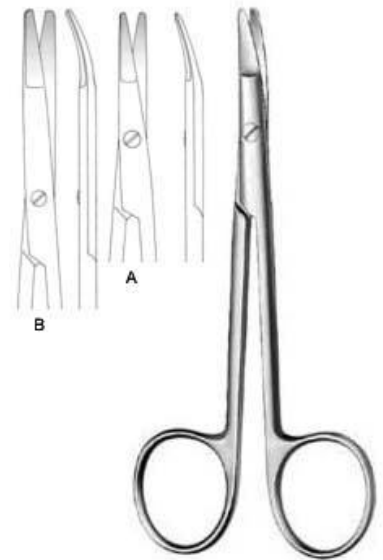

Kilner

PSI-5-256-12

Dissecting Scissors
12 cm, 15 cm

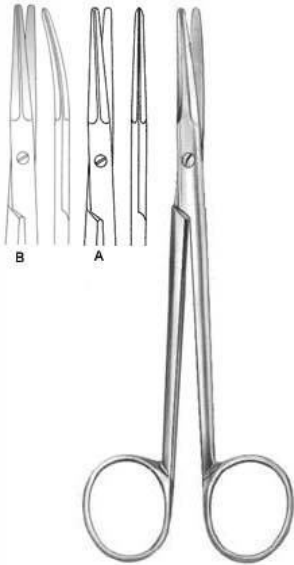

Dissecting Scissors

PSI-5-257-14

14.5 cm

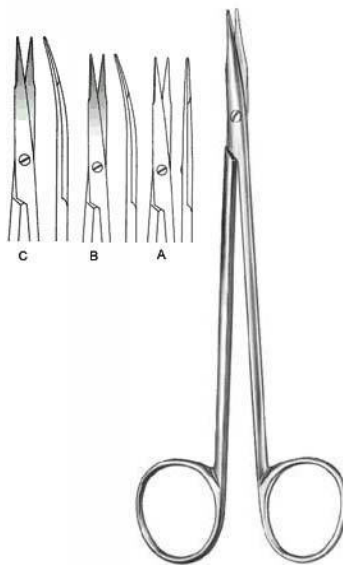

Reynolds

PSI-5-258-15

Dissecting Scissors
15.5 cm, 18 cm



Jameson

PSI-5-259-14

Dissecting Scissors
15.5 cm



Jameson

PSI-5-260-14

Dissecting Scissors
15.5 cm



Vascular Scissors

PSI-5-261-19

19 cm

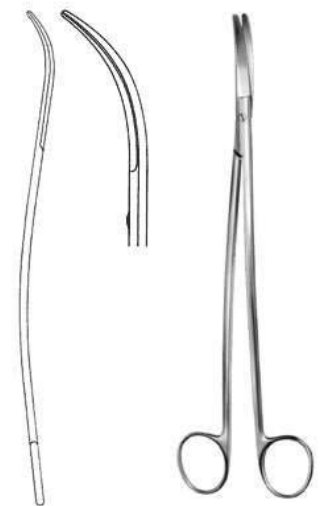

Vascular Scissors

PSI-5-262-24

19 cm , 25.5 cm

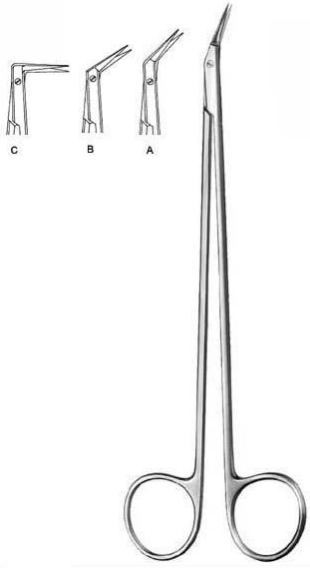

Diethrich

PSI-5-263-25

ascular Scissors
17.5 cm, 18.5 cm, 19 cm

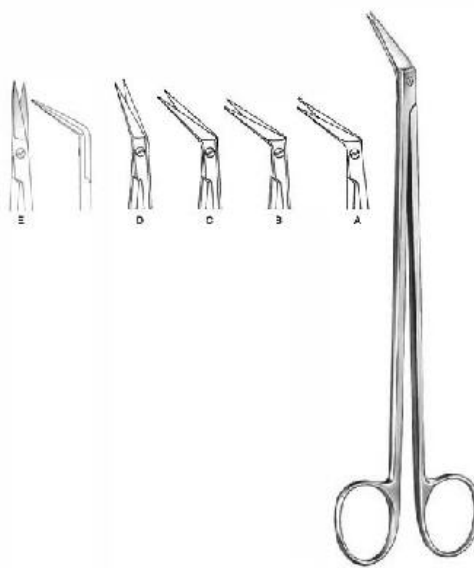

DeBakey

PSI-5-264-45

ascular Scissors
16 cm, 16.5 cm

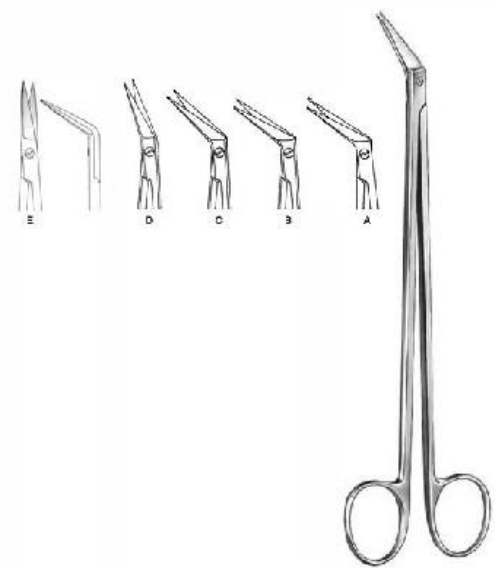

Potts-Smith

PSI-5-265-19

Vascular Scissors
18 cm, 18.5 cm, 19 cm



Coronary Scissors

PSI-5-267-45

Cardiovascular Surgery Scissors
18 cm



Coronary Scissors

PSI-5-267-45

Cardiovascular Surgery Scissors
18 cm



Coronary Scissors

PSI-5-268-60

18 cm



Schmieden-Taylor

PSI-5-275-17

Dura Scissors
15 cm



Strully

PSI-5-276-22

Neurosurgical Scissors
22.5 cm



Toennis-Adson

PSI-5-277-17

Dissecting Scissors
17.5 cm



Good

PSI-5-279-19

Tonsil Scissors
19.5 cm



Fomon

PSI-5-282-15

Nasal Scissors
15 cm



Cottle

PSI-5-283-16

Nasal Scissors
16 cm



Modell USA

PSI-5-290-10

Umbilical Scissors
10.5 cm



Busch

PSI-5-292-16

Umbilical Scissors
16 cm



Goldmann-Fox

PSI-5-293-13

Gum Scissors
13cm



Wagner

PSI-5-294-12

Operating Scissors
12 cm

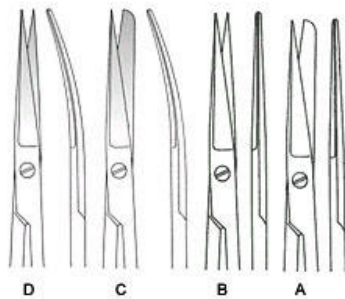

Operating Scissors

PSI-5-295-12

Operating Scissors small model
12 cm

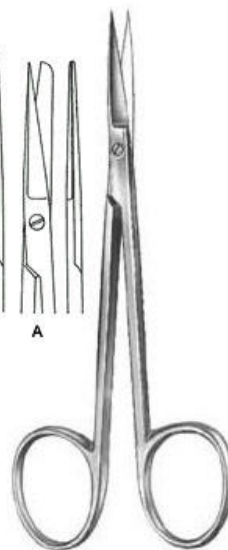

La Grange

PSI-5-296-11

Gum Scissors S-shaped
11.5cm



Dissecting Scissors

PSI-5-297-11

Dissecting Scissors 11.5cm
11.5cm



Locklin

PSI-5-298-16

Gum Scissors 16cm
16 cm



Locklin

PSI-5-299-16

Gum Scissors
16 cm



Operating Scissors

PSI-5-300-08

9

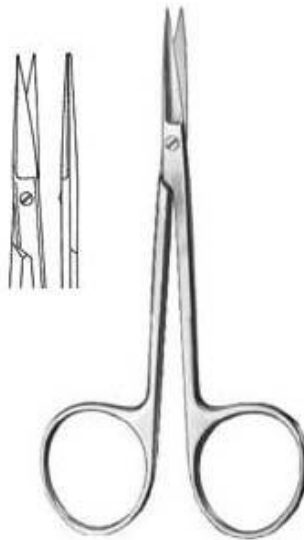

Iris Scissors

PSI-5-301-10

9 cm, 10 cm

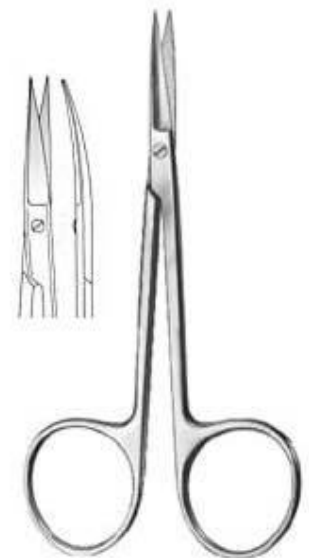

Iris Scissors

PSI-5-302-10

10 cm



Iris Scissors

PSI-5-303-10

10 cm



Bonn

PSI-5-304-09

Iris Scissors



Dean

PSI-5-278-17

Tonsil Scissors 17.5cm

17.5 cm



Spencer Scissor

PSI-0-

Spencer Scissor



Standard

PSI-5-401-10

Dressing Forceps

18.5 cm , 18.5 cm , 13cm, 14.5 cm , 16 cm, 18 cm,
20cm, 23 cm , 25 cm , 30.5 cm



Standard

PSI-5-402-11

Dressing Forceps

12 cm, 13cm, 14.5 cm , 16 cm, 18 cm, 20cm, 25
cm , 30 cm



Dressing Forceps

PSI-5-403-13

D

13cm, 14.5 cm



Stille

PSI-5-404-15

Dressing Forceps

15 cm



Mini-Adson

PSI-5-405-12

Dressing Forceps

12 cm



Adson

PSI-5-406-12

Dressing Forceps

12 cm, 15 cm



McIndoe

PSI-5-405-12

Dressing Forceps

15 cm



Waugh

PSI-5-408-20

Dressing Forceps

20cm



Semken

PSI-5-409-12

Dressing Forceps

12.5 cm, 15 cm



Taylor

PSI-5-410-17

Dressing Forceps

12.5 cm, 15 cm



Taylor

PSI-5-411-17

Dressing Forceps

17 cm



Taylor

PSI-5-412-17

Dressing Forceps

18.5 cm



Dressing Forceps

PSI-5-413-06

Dressing Forceps

15.5 cm



Gerald

PSI-5-414-18

Dressing Forceps

15.5 cm



Cushing

PSI-5-415-17

Dressing Forceps

17.5 cm



Potts-Smith

PSI-5-416-18

Dressing Forceps

18 cm, 21cm, 24.5 cm



Bonney

PSI-5-417-17

Dissecting Forceps

17.5 cm



Gerald

PSI-5-418-17

17.5 cm



Gillies

PSI-5-419-15

Dissecting Forceps
15.5 cm



McIndoe

PSI-5-420-15

Dissecting Forceps
15 cm



Semken

PSI-5-421-16

Dissecting Forceps
15.5 cm, 17.5 cm



Adson-Brown

PSI-5-422-12

Dissecting Forceps
12 cm



Adson

PSI-5-423-12

Dissecting Forceps
12 cm, 15 cm



Adson

PSI-5-424-12

Dressing Forceps
12 cm, 15 cm



Cushing

PSI-5-425-17

Dressing Forceps

17.5 cm



Cushing

PSI-5-426-18

Dressing Forceps

17 cm



Cushing-Taylor

PSI-5-427-18

Dressing Forceps

18.5 cm



Potts-Smith

PSI-5-428-15

Dressing Forceps

16 cm, 18.5 cm, 20cm, 23 cm, 25 cm



Oehler

PSI-5-429-14

Dissecting Forceps

14.5 cm, 16 cm, 18 cm, 20cm, 25 cm



Wangensteen

PSI-5-430-15

Dressing Forceps

15 cm, 23 cm



Dissecting Forceps

PSI-5-437-13

Dissecting Forceps
13 cm , 14.5 cm , 16 cm , 20cm



Dissecting Forceps

PSI-5-438-13

Dissecting Forceps
13 cm , 14.5 cm



Stille

PSI-5-439-15

Dissecting Forceps
15 cm



Stille

PSI-5-440-15

Dissecting Forceps
15 cm



Stone

PSI-5-441-15

Dissecting Forceps
15 cm



Lerche

PSI-5-442-15

Dissecting Forceps
15 cm



Adlerkreutz

PSI-5-443-15

Dissecting Forceps

15.5 cm, 20.5 cm, 16 cm, 20cm, 25 cm

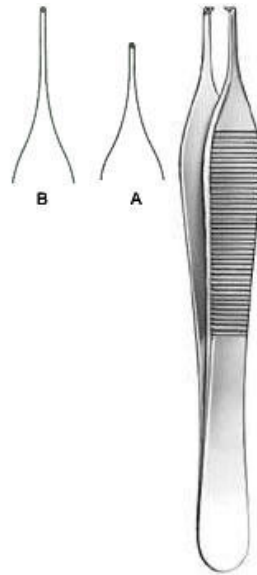

Adson

PSI-5-444-12

Dissecting Forceps

12 cm, 15 cm



Gillies

PSI-5-445-15

Dissecting Forceps

15.5 cm



Waugh

PSI-5-446-20

Dissecting Forceps

20.5 cm



Semken

PSI-5-447-12

Dissecting Forceps

12.5 cm, 15 cm



Taylor

PSI-5-448-17

Dissecting Forceps

17.5 cm



Taylor

PSI-5-449-17

Dissecting Forceps
17 cm



Taylor

PSI-5-450-17

Dissecting Forceps
18.5 cm



Dissecting Forceps

PSI-5-451-06

Dissecting Forceps
15.5 cm



Gerald

PSI-5-452-17

Dissecting Forceps
17.5 cm



Cushing

PSI-5-453-17

Dissecting Forceps
18 cm



Potts-Smith

PSI-5-454-18

Dissecting Forceps
18 cm, 21cm, 24 cm

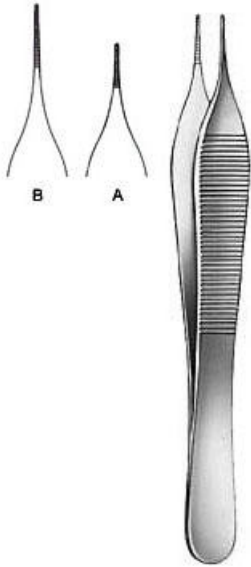

Mikro-Adson

PSI-5-455-12

Dressing Forceps
12 cm, 15 cm

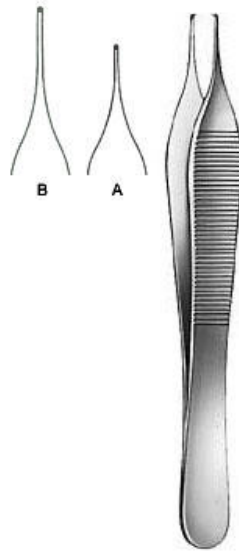

Mikro-Adson

PSI-5-456-12

Dissecting Forceps
12 cm, 15 cm



Dissecting Forceps

PSI-5-457-11

Dissecting Forceps
10.5 cm



Micro Jewelers

PSI-5-458-12

Jeweler Type Forceps
12 cm Fig. 7



Jewelers

PSI-5-459-12

Jeweler Type Forceps
12 cm Fig. 3



Jewelers

PSI-5-460-11

Jeweler Type Forceps
11 cm Fig. 3c



Jewelers

PSI-5-461-11

Jeweler Type Forceps
11 cm Fig. 5



Jewelers

PSI-5-462-11

Jeweler Type Forceps
11 cm Fig. 4



Stille-Barraya

PSI-5-463-18

Dissecting Forceps
18 cm



Bonney

PSI-5-464-18

Dissecting Forceps
17.5 cm



Nelson

PSI-5-465-23

Dissecting Forceps
23 cm



Dressing Forceps

PSI-5-466-10

Dressing Forceps
10 cm , 9.5 cm



Splinter Forceps Smooth Jaw

PSI-5-467-12

Splinter Forceps smooth jaw
12.5 cm



Splinter Forceps Smooth Jaw

PSI-5-468-12

Splinter Forceps smooth jaw
12.5 cm



Splinter Forceps

PSI-5-469-12

Splinter Forceps
12.5 cm



Splinter Forceps

PSI-5-470-12

Splinter Forceps
12.5 cm



Micro Tying Forceps

PSI-5-471-16

Micro Tying Forceps
15.5 cm



**Microscopic Forceps Super Light,
Blunt**

PSI-5-472-10

Microscopic Forceps super light, blunt
10 cm



Microscopic Forceps

PSI-5-473-10

Microscopic Forceps
10 cm



Shaaf

PSI-5-474-09

Splinter Forceps
9.5 cm



Littauer

PSI-5-475-08

Cilia Forceps
8.5 cm



Cilia Forceps

PSI-5-476-09

Cilia Forceps
8.5 cm



Douglas

PSI-5-477-09

Cilia Forceps
9 cm



Douglas

PSI-5-478-09

Cilia Forceps
9 cm



Beer

PSI-5-479-09

Cilia Forceps

9 cm



Phaneuf

PSI-5-501-21

Hysterectomy Forceps
20.5 cm



Wertheim-Cullen

PSI-5-502-21

Vaginal Clamp
21 cm

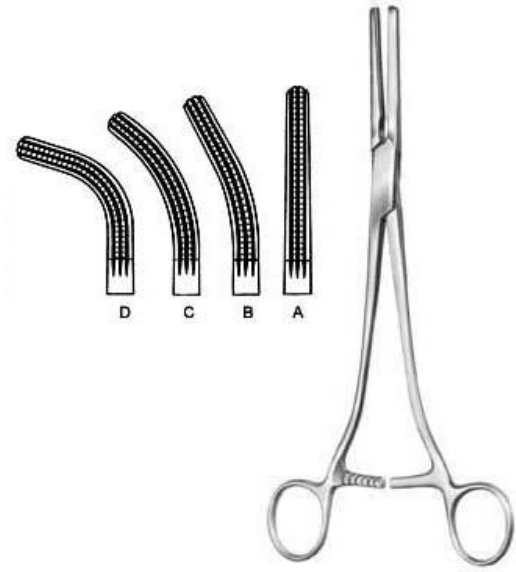

Rogers

PSI-5-503-10

Hysterectomy Forceps
21.5 cm Fig. 1, 21 cm Fig. 2, 20.5 cm Fig. 3, 20 cm Fig. 4



Moynihan

PSI-5-504-23

Hysterectomy Forceps
23 cm



Moynihan

PSI-5-505-24

Hysterectomy Forceps
23.5 cm



Wertheim

PSI-5-506-25

Hysterectomy Forceps
26 cm

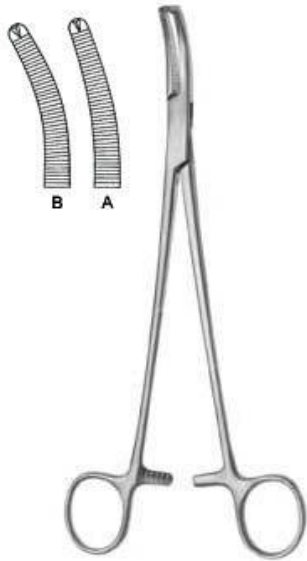

Wertheim

PSI-5-507-22

Hysterectomy Forceps

22.5 cm



Mikulicz, Baby

PSI-5-508-14

Peritoneum Forceps

14.5 cm



Mikulicz

PSI-5-509-18

Peritoneum Forceps

20.5 cm



Mikulicz

PSI-5-510-20

Peritoneum Forceps

18.5 cm



Mikulicz

PSI-5-511-20

Peritoneum Forceps

20cm



Mikulicz

PSI-5-512-21

Peritoneum Forceps

20.5 cm



Faure

PSI-5-513-20

Peritoneum Forceps

21 cm

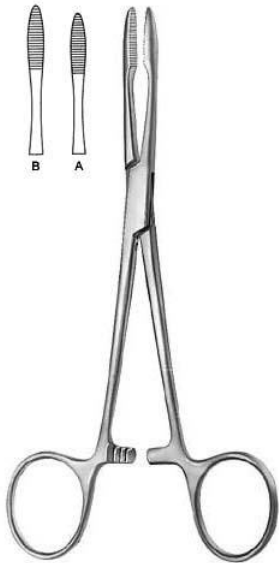

Pean

PSI-5-601-14

Haemostatic Forceps
14.5 cm , 16 cm

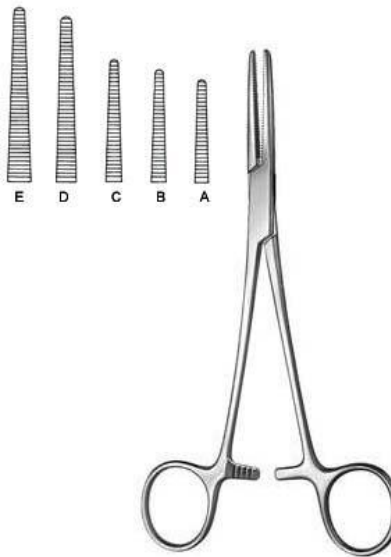

Spencer-Wells

PSI-5-602-13

Haemostatic Forceps
13 cm , 14 cm, 15.5 cm, 18.5 cm , 20 cm

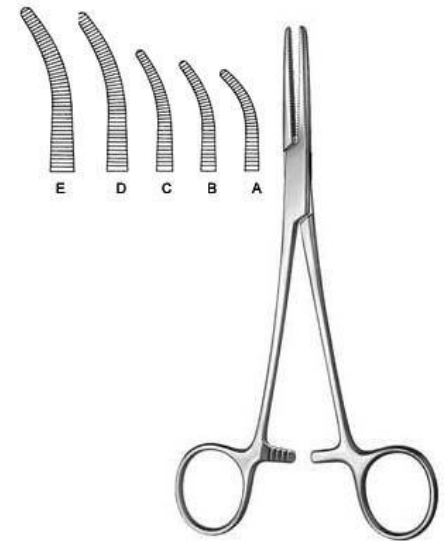

Spencer-Wells

PSI-5-603-13

Haemostatic Forceps
13 cm , 14 cm, 15 cm, 18 cm, 20 cm



Chaput

PSI-5-604-13

Haemostatic Forceps
12.5 cm



Tuffier

PSI-5-605-13

Haemostatic Forceps
12.5 cm

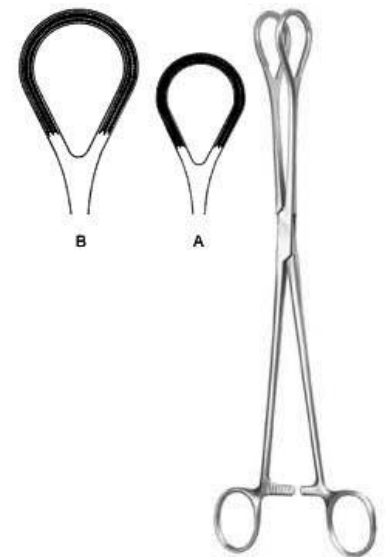

Grasping Forceps

PSI-5-606-25

Organ Grasping For



Collin

PSI-5-607-14

Organ Grasping Forceps
12.5 cm, 21 cm



Collin

PSI-5-608-17

Tumor Grasping Forceps
17 cm



Pennington

PSI-5-609-15

Haemostatic Forceps
15.5 cm



Pratt

PSI-5-610-15

Haemostatic Forceps
15 cm



Martel-Rees

PSI-5-611-14

Face-lift Forceps
13.5 cm



Ligature Forceps

PSI-5-612-12

Ligature Forceps

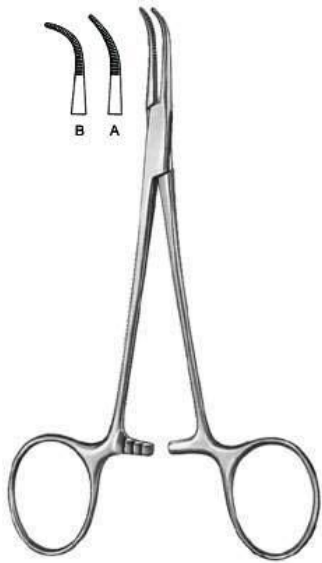

Mixer-Baby

PSI-5-613-01

Dissecting and Ligature Forceps
13 cm , 13.5 cm

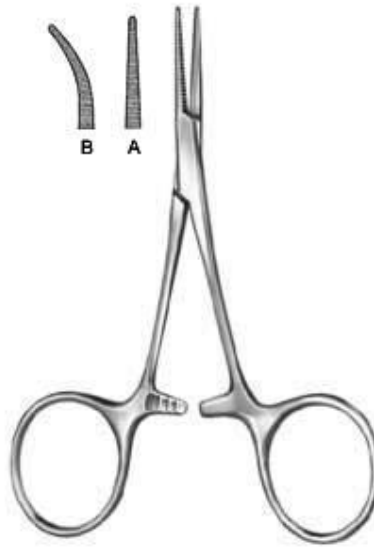

Hartmann

PSI-5-614-10

Haemostatic Forceps
9.5 cm, 10 cm



Ligature Forceps

PSI-5-615-12

Ligature Forceps

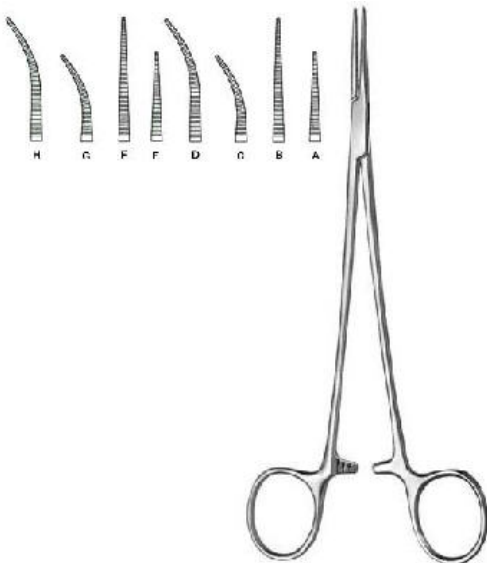

Halsted-Mosquito

PSI-5-616-18

Haemostatic Forceps
12.5 cm, 14 cm, 14.5 cm

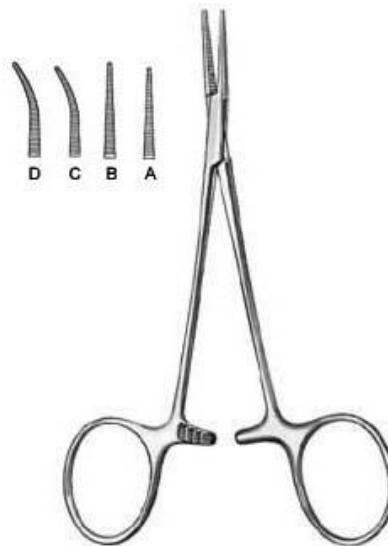

Mikro-Mosquito

PSI-5-617-10

Haemostatic Forceps
9.5 cm, 10 cm , 11.5 cm, 12 cm



Providence-Hospital

PSI-5-618-14

Haemostatic Forceps
14 cm



Leriche

PSI-5-619-15

Haemostatic Forceps
15 cm, 15.5 cm

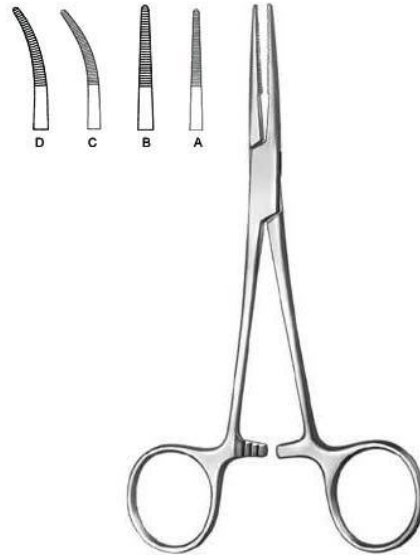

Kelly

PSI-5-620-14

Haemostatic Forceps
14 cm, 14.5 cm

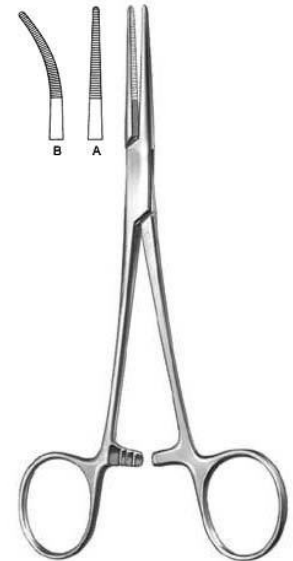

Kelly-Rankin

PSI-5-621-16

Haemostatic Forceps
15.5 cm, 16 cm



Overholt-Baby

PSI-5-622-14

Dissecting and Ligature Forceps
14 cm, 14.5 cm



Crile

PSI-5-623-14

Haemostatic Forceps
14 cm, 14.5 cm



Crile-Rankin

PSI-5-624-16

Haemostatic Forceps
16 cm, 16.5 cm

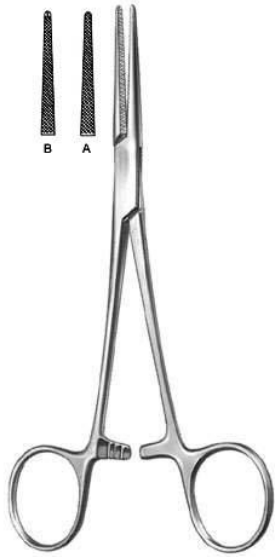

Lovelace

PSI-5-625-15

Haemostatic Forceps

16 cm



Dandy-Mosquito

PSI-5-626-12

Haemostatic Forceps

12 cm

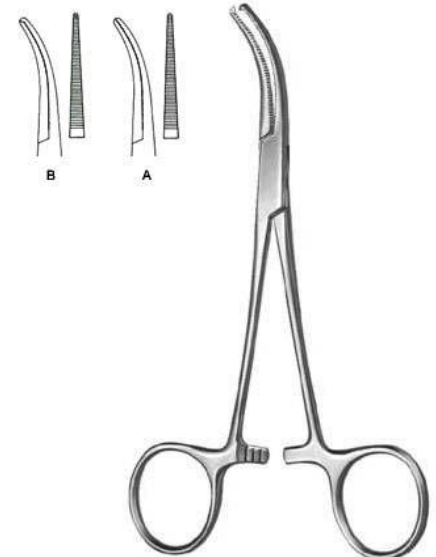

Dandy

PSI-5-627-14

Haemostatic Forceps

14 cm, 14.5 cm



Schmidt

PSI-5-628-18

Dissecting and Ligature Forceps

18.5 cm , 19 cm



Adson

PSI-5-629-18

Dissecting and Ligature Forceps

18.5 cm , 19 cm



Martin-Fuchsig

PSI-5-630-20

Dissecting and Ligature Forceps

20.5 cm

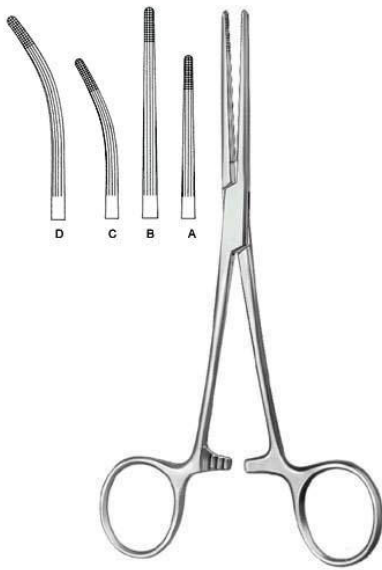

Rochester-Carmalt

PSI-5-631-16

Haemostatic Forceps
16.5 cm , 17 cm , 20 cm , 20.5 cm

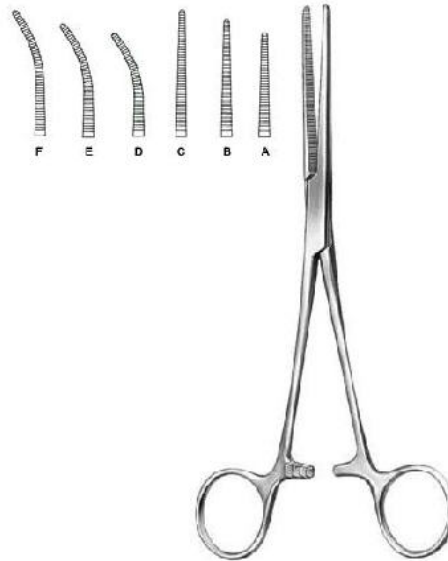

Pean

PSI-5-632-13

Haemostatic Forceps
13 cm , 13.5 cm , 14 cm , 14.5 cm , 16.5 cm , 17 cm

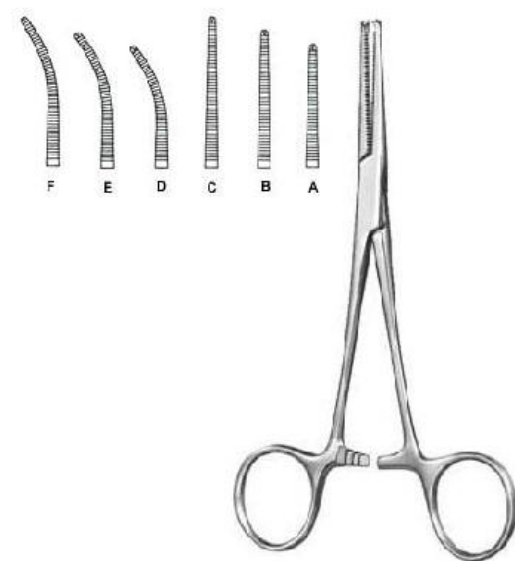

Kocher-Nippon

PSI-5-633-14

Haemostatic Forceps
14.5 cm , 16 cm , 16.5 cm , 18 cm , 18 cm

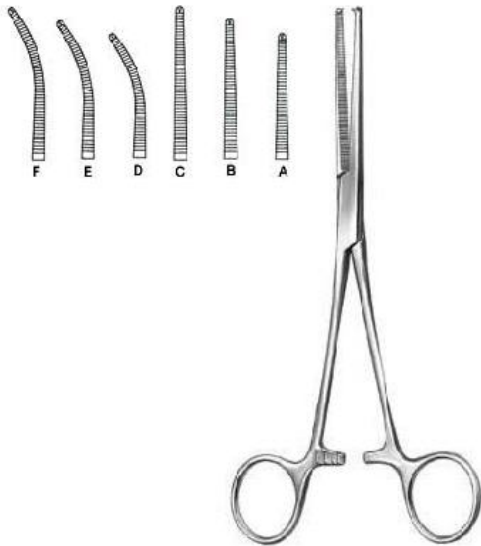

Kocher

PSI-5-635-13

Haemostatic Forceps
13 cm , 14 cm , 16 cm

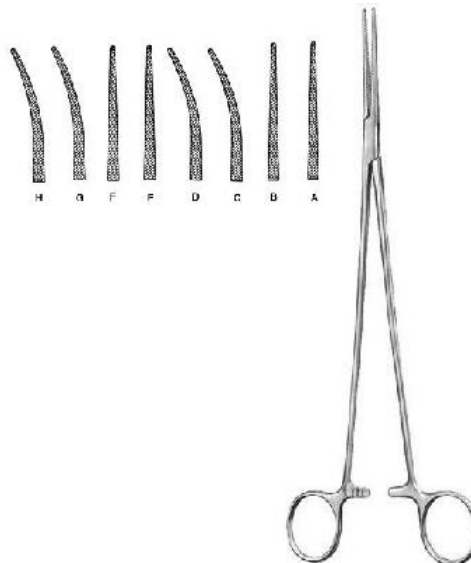

Bengolea

PSI-5-636-20

Haemostatic Forceps
21 cm , 21.5 cm , 26 cm

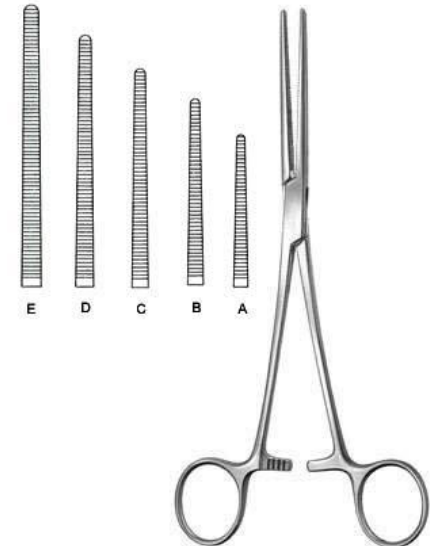

Pean (Rochester)

PSI-5-637-14

Haemostatic Forceps
14 cm , 14.5 cm , 16 cm , 16.5 cm , 18.5 cm , 20.5 cm , 22.5 cm , 24.5 cm , 26 cm , 30.5 cm

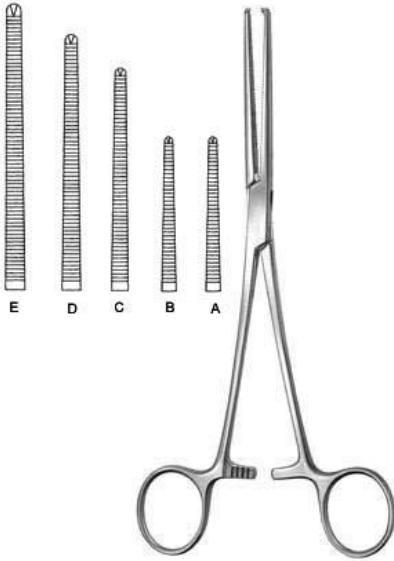

Kocher (Ochsner)

PSI-5-638-14

Haemostatic Forceps

14.5 cm , 16.5 cm , 18.5 cm , 20.5 cm , 22.5 cm ,
24.5 cm , 26 cm , 30.5 cm

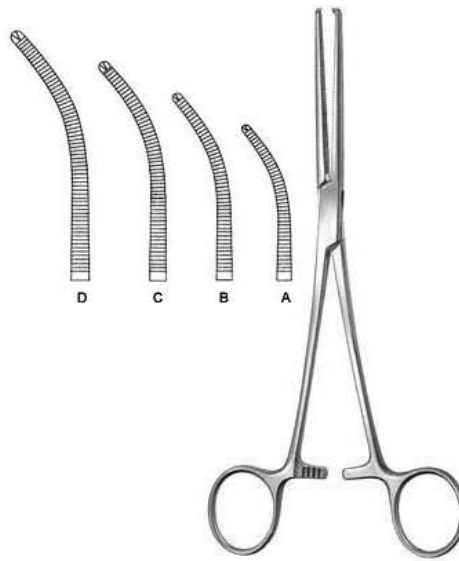

Kocher (Ochsner)

PSI-5-639-14

Haemostatic Forceps

14 cm , 16 cm , 18 cm , 20 cm , 22 cm , 24 cm , 25.5
cm , 30 cm

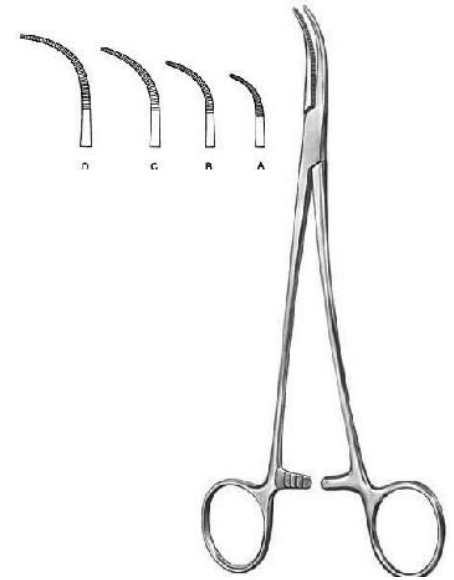

Overholt-Martin

PSI-5-640-01

Dissecting and Ligature Forceps

18.5 cm Fig. 1 , 20.5 cm Fig. 2 , 21 cm Fig. 3 , 21.5
cm Fig. 4 , 24.5 cm Fig. 5



Mixer-Baby

PSI-5-641-18

Dissecting and Ligature Forceps

18.5 cm



Adson-Baby

PSI-5-642-14

Dissecting and Ligature Forceps

14.5 cm , 18 cm



Heiss

PSI-5-643-20

Dissecting and Ligature Forceps

20 cm , 20.5 cm , 21 cm



Overholt-Mixter

PSI-5-644-21

Dissecting and Ligature Forceps
21.5 cm

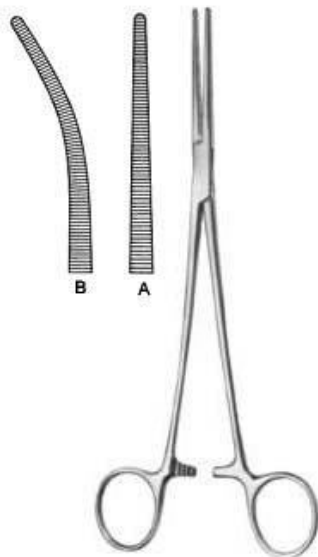

Roberts

PSI-5-645-22

Dissecting and Ligature Forceps
21.5 cm, 22.5 cm

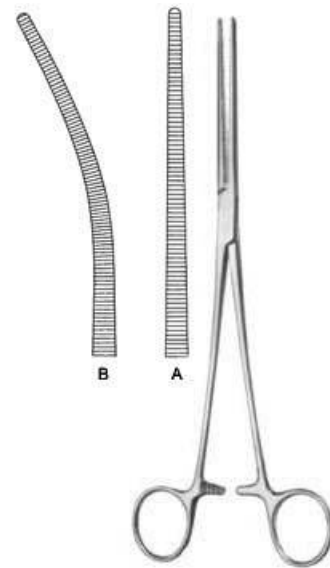

Sarot

PSI-5-646-24

Dissecting and Ligature Forceps
24.5 cm, 25 cm

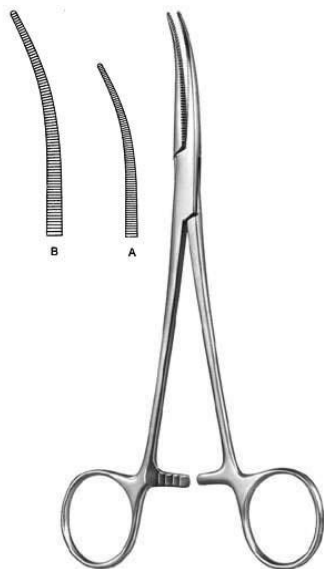

Crafoord

PSI-647-18

Dissecting and Ligature Forceps
18 cm, 24.5 cm

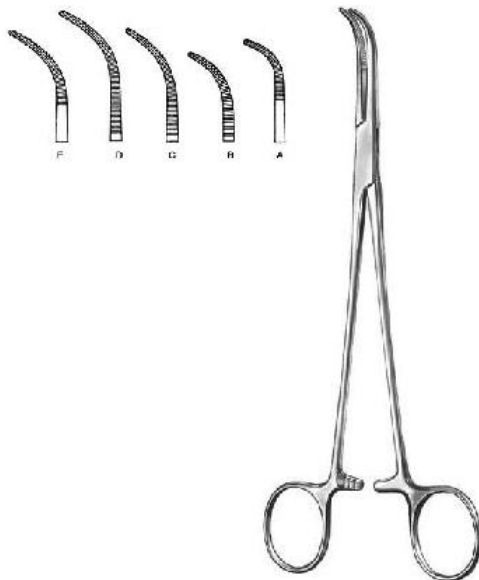

Overholt-Geissendorfer

PSI-5-648-01

Dissecting and Ligature Forceps
20.5 cm Fig. 1, 20 cm Fig. 2, 21.5 cm Fig. 3, 22 cm Fig. 4, 21.5 cm Fig. 5, 22 cm Fig. 6, 27 cm Fig. 1, 26.5 cm Fig. 2, 27.5 cm Fig. 3, 28 cm Fig. 4

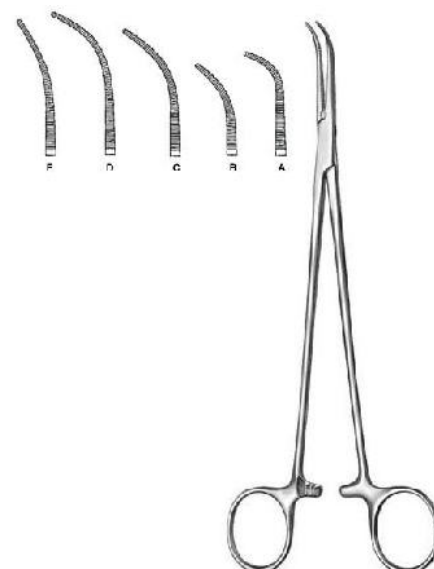

Overholt-Fino

PSI-5-649-00

Dissecting and Ligature Forceps
21 cm, 21.5 cm, 22 cm, 22.5 cm, 23 cm

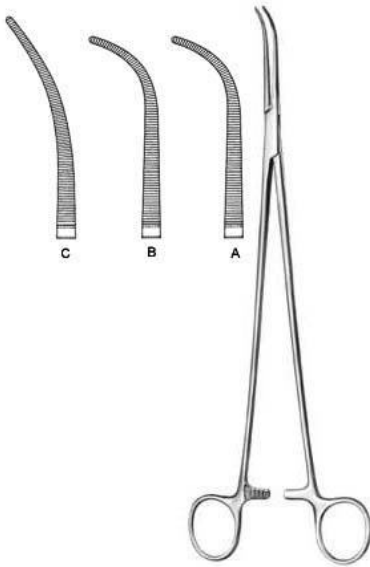

Overholt

PSI-5-650-00

Dissecting and Ligature Forceps
29.5 cm, 30 cm



Overholt-Mini

PSI-5-651-01

Dissecting and Ligature Forceps
15 cm, 20 cm

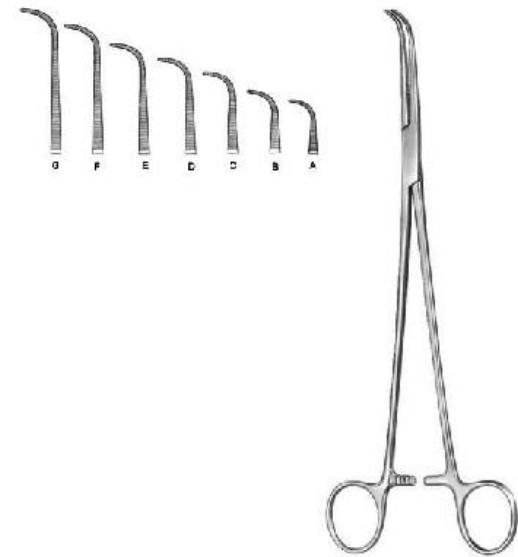

Gemini

PSI-5-652-13

Dissecting and Ligature Forceps
13 cm , 16 cm, 18 cm, 21 cm, 23 cm , 25 cm , 28 cm

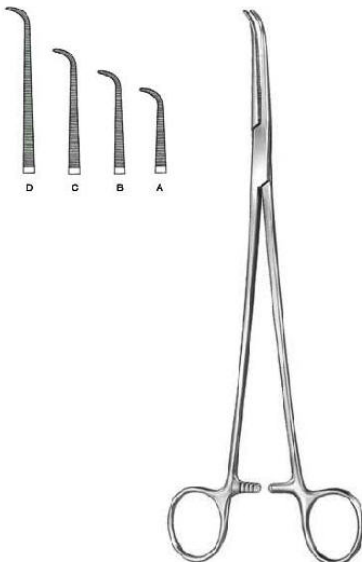

Mini-Gemini

PSI-5-653-18

Dissecting and Ligature Forceps
18 cm, 22.5 cm, 25 cm , 28.5 cm

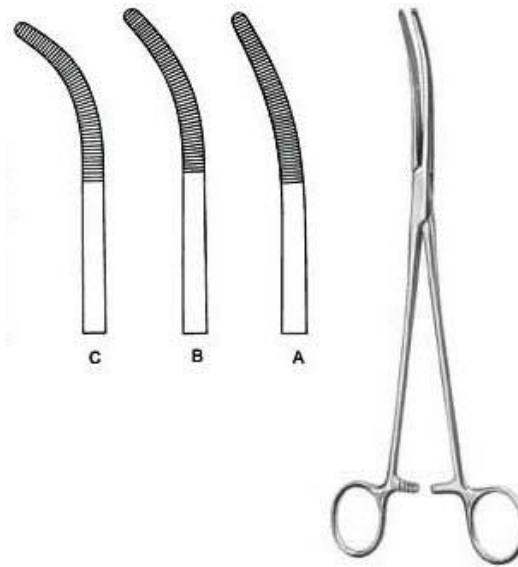

Rumel

PSI-5-654-01

Dissecting and Ligature Forceps
24 cm Fig. 1 , 23.5 cm Fig. 2 , 23 cm Fig. 3, 24 cm Fig. 4
, 23.5 cm Fig. 5

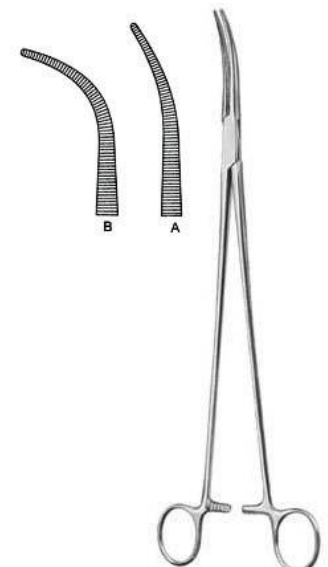

Zenker

PSI-5-655-01

Dissecting and Ligature Forceps
28.5 cm, 29.5 cm



Mixer-Baby

PSI-5-656-14

Dissecting and Ligature Forceps
13.5 cm



Mixer

PSI-5-657-15

Dissecting and Ligature Forceps
16 cm, 18 cm



Mixer-O Shaugnessy

PSI-5-658-19

Dissecting and Ligature Forceps
18 cm



Mixer

PSI-5-659-22

Dissecting and Ligature Forceps
22.5 cm



Mixer

PSI-5-660-23

Dissecting and Ligature Forceps
23 cm



Wickstrom

PSI-5-661-21

Dissecting and Ligature Forceps
21 cm, 24.5 cm

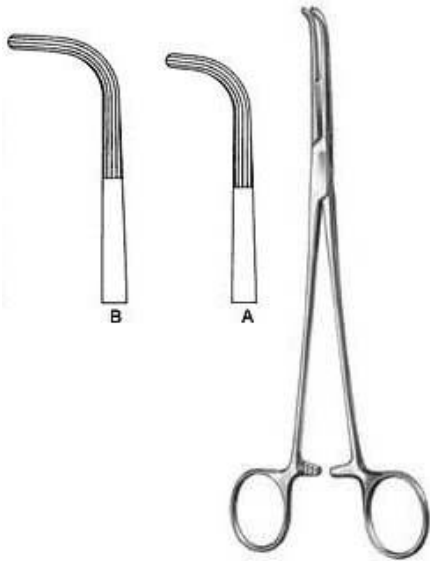

Mixer

PSI-5-662-22

Dissecting and Ligature Forceps
22.5 cm, 26 cm, 28 cm



Mc Quigg-Mixer

PSI-5-663-22

Dissecting and Ligature Forceps
23.5 cm



Lower

PSI-5-664-18

Dissecting and Ligature Forceps
18.5 cm

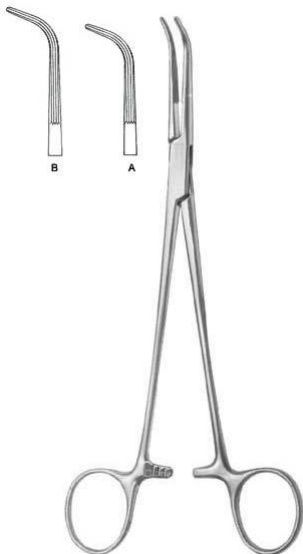

Lahey

PSI-5-665-19

Bile Duct Clamp
19.5 cm, 22.5 cm



Finochietto

PSI-5-666-24

Dissecting and Ligature Forceps
24 cm

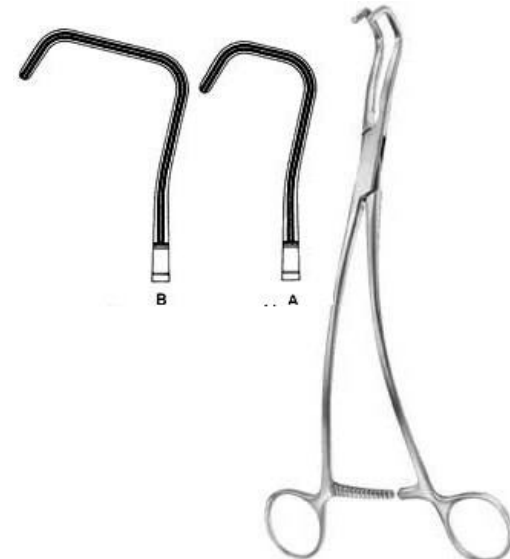

Uro-Tangential

PSI-5-667-01

Tangential Forceps
25 cm, 27 cm

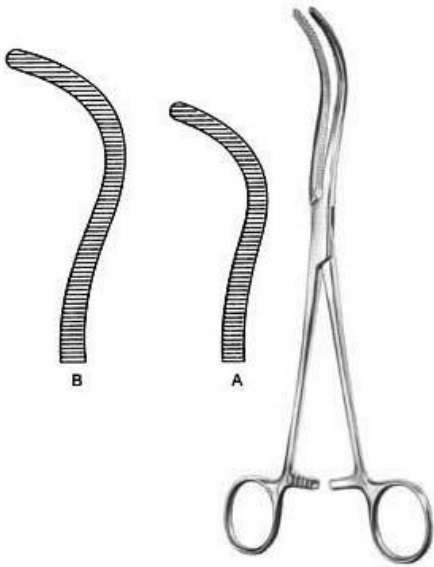

Guyon

PSI-5-668-20

Kidney Pedicle Clamp
23 cm , 24 cm



Guyon

PSI-5-669-23

Kidney Pedicle Clamp
19.5 cm , 21.5 cm, 24 cm



Desjardins

PSI-5-670-21

Bile Duct Clamp
21 cm

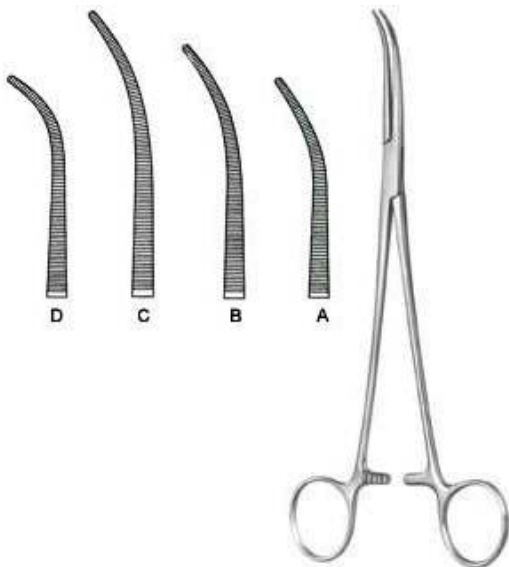

Kelly

PSI-5-671-19

Dissecting and Ligature Forceps
19.5 cm Fig. 1 , 22.5 cm Fig. 1 , 24.5 cm Fig. 1 , 19 cm
Fig. 2 , 22 cm Fig. 2 , 24 cm Fig. 2 , 18.5 cm Fig. 3 , 23.5
cm Fig. 3, 21.5 cm Fig. 3



Lawrence

PSI-5-672-28

Dissecting and Ligature Forceps
28 cm



Meeker

PSI-5-673-28

Dissecting and Ligature Forceps
28 cm



Negus

PSI-5-674-19

Haemostatic Forceps
19.5 cm Fig. 1 , 20 cm Fig. 2



Schaedel

PSI-5-701-09

Towel Clamp sharp
9 cm



Jones

PSI-5-702-05

Towel Clamp sharp
5.5 cm, 8.5 cm



Jones-Martin

PSI-5-703-09

Towel Clamp sharp
8.5 cm



Backhaus

PSI-5-705-11

Towel Clamp
11.5 cm



Backhaus

PSI-5-706-08

Towel Clamp
9 cm, 11.5 cm, 13 cm , 16 cm



Peers-Bertram Modif.

PSI-5-707-15

Towel Clamp wide jaw for tube fixation
15.5 cm



R?Der

PSI-5-708-13

Towel Clamp
13.5 cm

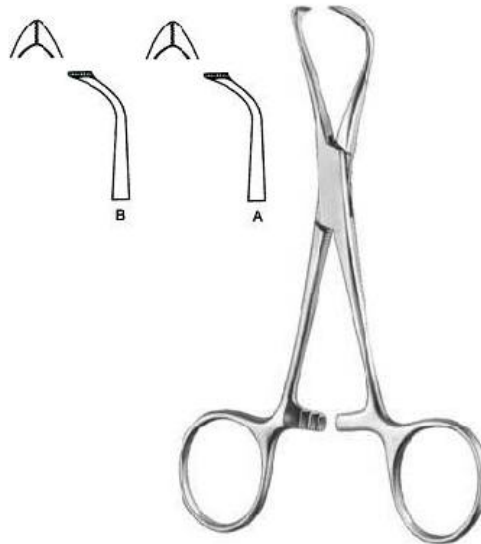

Lorna

PSI-5-709-10

Towel Clamp fine serrated, wide jaw
9.5 cm, 13 cm



Bernhard

PSI-5-710-16

Towel Clamp
16.5 cm

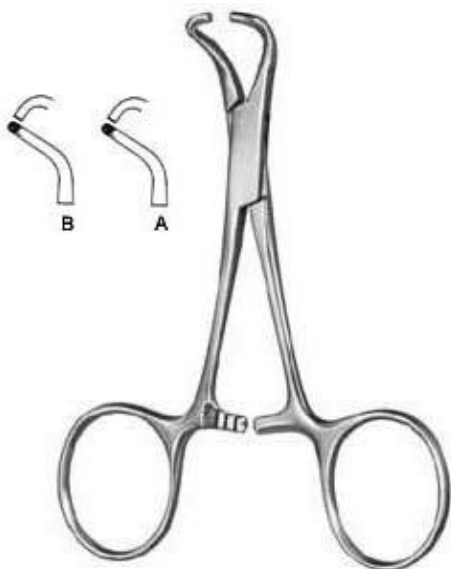

Tohoku

PSI-5-711-10

Towel Clamp
10.5 cm blunt, 13.5 cm blunt, 14.5 cm

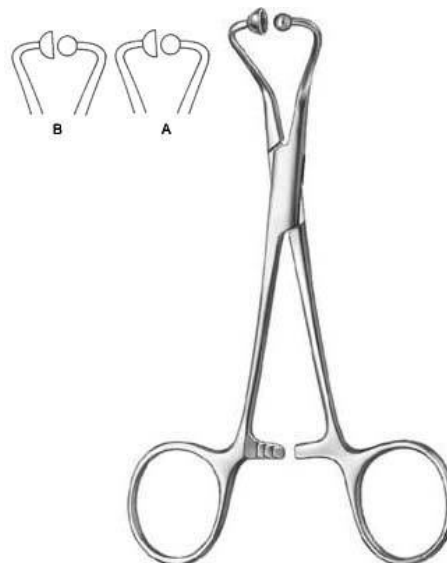

Towel Clamp For Paper Clothes

PSI-5-712-11

Towel Clamp for paper clothes
11.5 cm, 14 cm



Lane

PSI-5-713-20

Lane
19.5 cm



Tube Holder For Fixation Of Six Tubes

PSI-5-714-06

Tube Holder for fixation of six tubes



Tubing Clamp Extra Long Ratchet

PSI-5-715-14

Tubing Clamp extra long ratchet
14 cm



Tubing Clamp

PSI-5-716-16

Tubing Clamp
16.5 cm

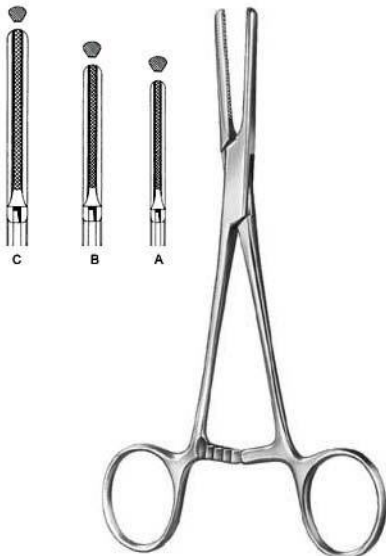

Tubing Clamp

PSI-5-717-15

Tubing Clamp
15.5 cm, 19 cm, 20.5 cm

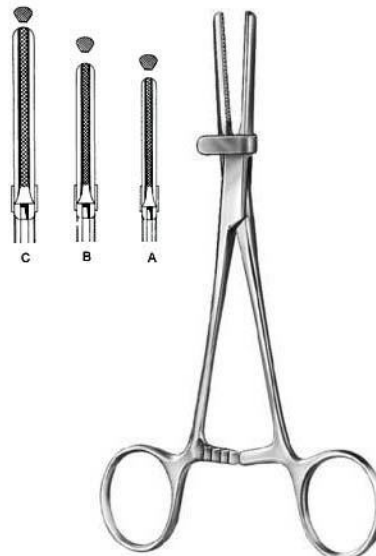

Tubing Clamp With Safety Guard

PSI-5-718-15

Tubing Clamp with safety guard
15.5 cm, 19 cm, 20.5 cm

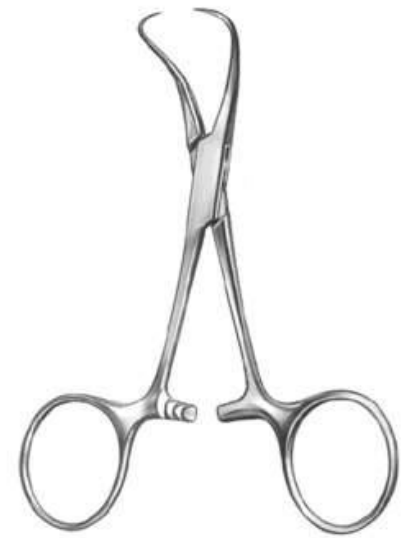

Backhaus

PSI-5-704-11

Towel Clamp
11.5 cm, 13 cm

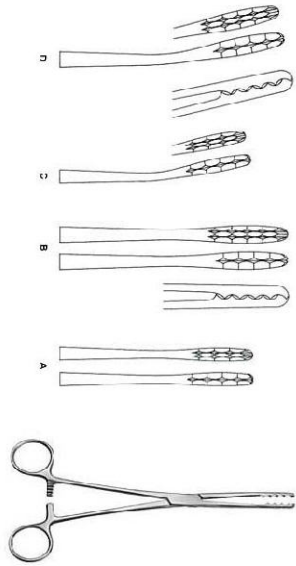

Ulrich

PSI-5-801-22

Dressing Forceps
21.5 cm, 26.5 cm



Lister

PSI-5-802-13

Sinus Forceps
13 cm, 16 cm, 18 cm



Martin

PSI-5-803-17

Dressing Forceps
17.5 cm, 17 cm

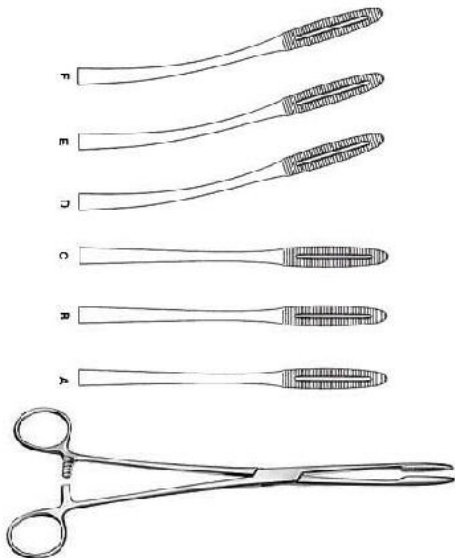

Gross-Maier

PSI-5-804-20

Dressing Forceps
20.5 cm, 22 cm, 26.5 cm, 20 cm, 21.5 cm, 26 cm



Tunneling Forceps

PSI-5-805-40

Tunneling Forceps
39.5 cm



Collin

PSI-5-806-25

Dressing Forceps
25.5 cm

SURGICAL INSTRUMENTS

Dressing & Sponge Forceps



Cheron

PSI-5-807-25

Dressing Forceps
23.5 cm



Bozemann

PSI-5-808-26

Sponge Forceps
26 cm

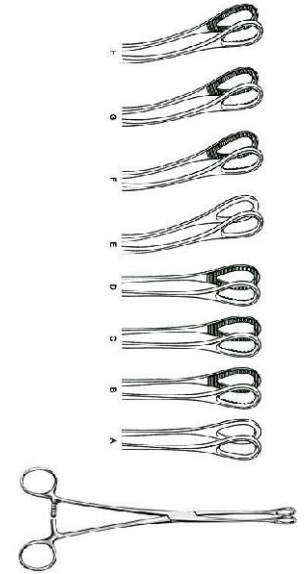

Foerster

PSI-5-809-25

Sponge Forceps
25 cm , 18 cm, 20.5 cm, 24.5 cm, 17.5 cm, 20 cm,
24.5 cm

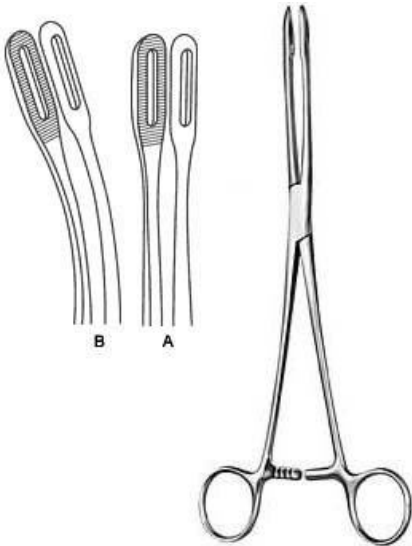

Foerster

PSI-5-810-25

Sponge Forceps
25 cm , 24.5 cm

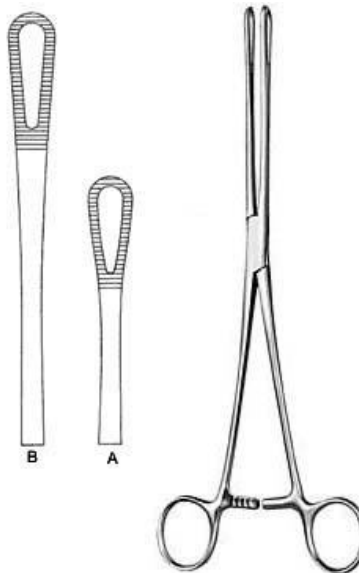

Rampley

PSI-5-811-18

Sponge Forceps
18.5 cm , 24.5 cm



Vickers
PSI-5-901-18
Skin Hooklet
18.5 cm



Vickers
PSI-5-902-01
Bone Hooklet
17 cm



Vickers
PSI-5-903-01
Tendon Hooklet
17 cm



Vickers
PSI-5-904-02
Hooklet
16 cm

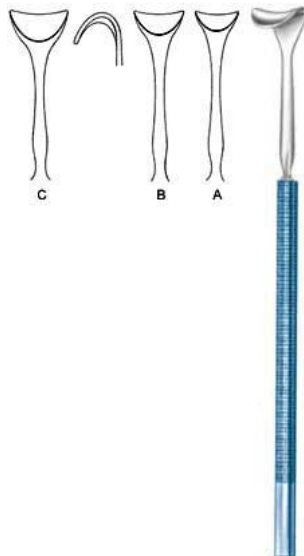

Vickers
PSI-5-905-12
Saddle Hook
14 cm



Graefe
PSI-5-906-01
Micro Hooklet
15 cm

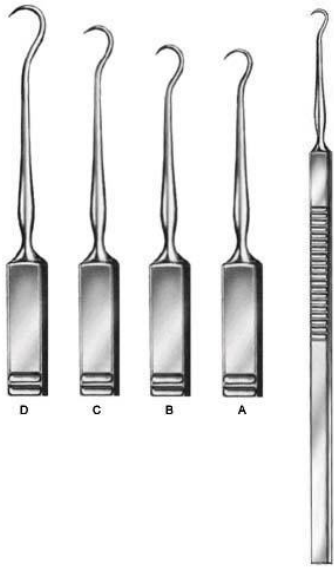

Skin Hook

PSI-5-907-01

Skin Hook

16 cm Fig. 1, 16 cm Fig. 2, 16 cm Fig. 3, 16 cm Fig. 4



O Connor

PSI-5-908-16

Skin Hook

16 cm

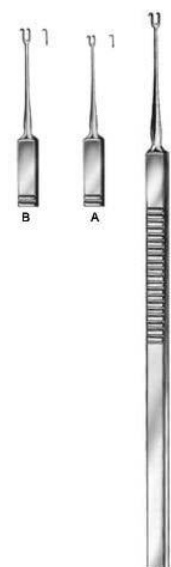

Guthrie

PSI-5-909-01

Skin Hook

15.5 cm

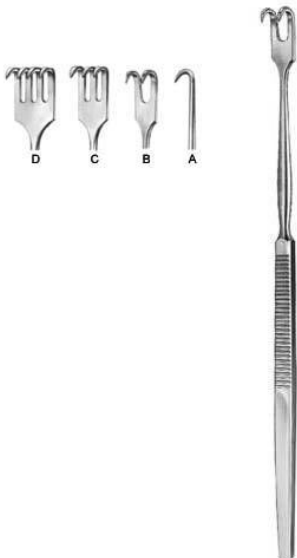

Hooklet

PSI-5-910-01

Hooklet

16.5 cm



Hooklet

PSI-5-911-01

Hooklet

16.5 cm



Hooklet

PSI-5-912-02

Hooklet

16 cm



Hooklet

PSI-5-913-04

Hooklet
16.5 cm



Vessel Hook

PSI-5-914-12

Vessel Hook
12 cm

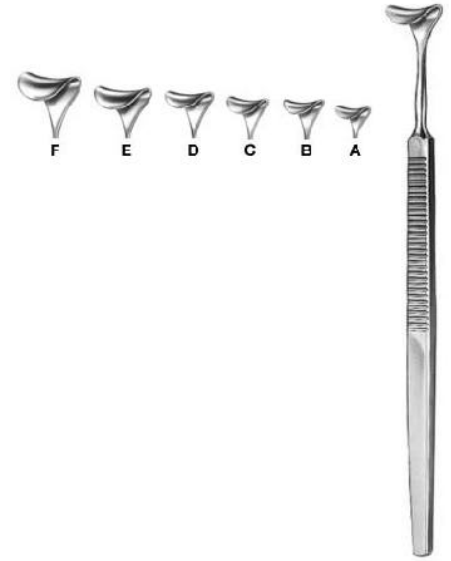

Desmarres

PSI-5-915-08

Saddle Hook
16 cm 8 mm, 16 cm 10 mm, 16 cm 12 mm, 16 cm
14 mm, 16 cm 16 mm, 16 cm 18 mm

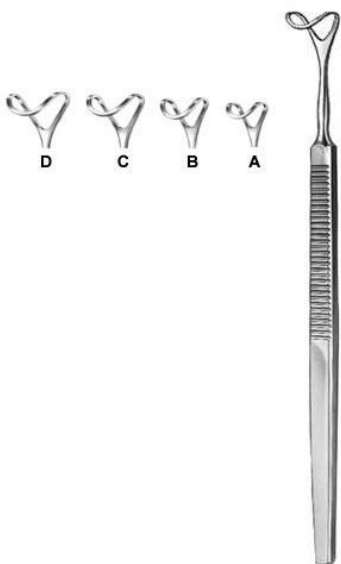

Saddle Hook

PSI-5-916-12

Saddle Hook
16 cm 12 mm, 16 cm 14 mm, 16 cm 16 mm, 16
cm 18 mm

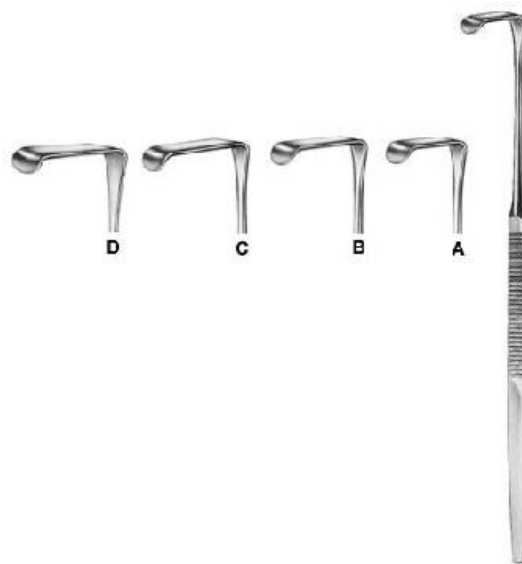

Langenbeck-Mini

PSI-5-917-10

Langenbeck-Mini
16 cm



Hooklet

PSI-5-918-16

Hooklet
16 cm 14 x 8



Hooklet

PSI-5-919-01

Hooklet
16.5 cm



Hooklet

PSI-5-920-01

Hooklet
16.5 cm



Meyerding

PSI-5-921-01

Hooklet
17.5 cm Fig. 1, 17.5 cm Fig. 2, 17.5 cm Fig. 3, 17.5 cm Fig. 4, 17.5 cm Fig. 5, 17.5 cm Fig. 6



Senn-Green

PSI-5-922-01

Hooklet
15 cm Fig. 1, 15 cm Fig. 2



Ragnell-Davis

PSI-5-923-14

Hooklet
14 cm

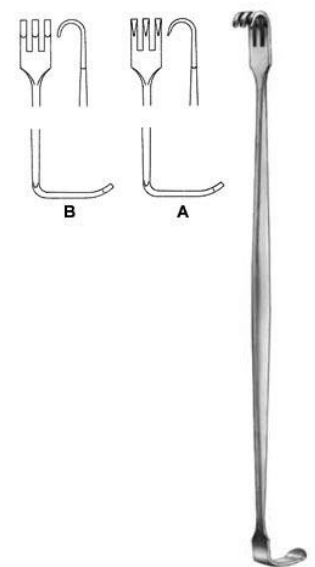

Senn-Miller

PSI-5-924-16

Hooklet
16 cm



Cushing

PSI-5-925-20

Cushing
20.5 cm



Cushing

PSI-5-926-08

Saddle Hook
20.5 cm 8 mm wide, 20.5 cm 10 mm wide, 20.5 cm 12 mm wide, 20.5 cm 14 mm wide, 20.5 cm 16 mm wide, 20.5 cm 18 mm wide

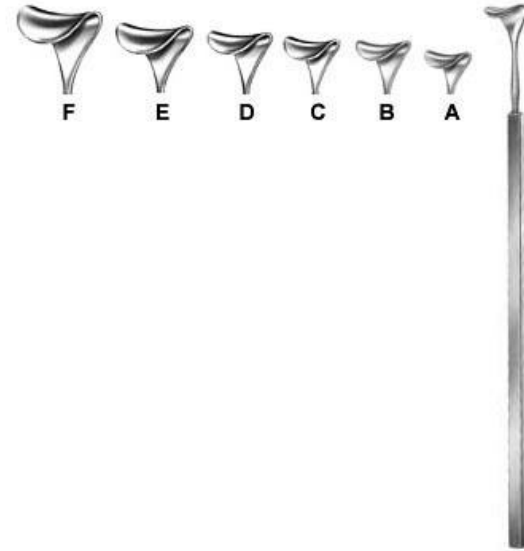

Cushing

PSI-5-927-08

Saddle Hook 8 mm to 18 mm wide
24 cm



Brom

PSI-5-928-01

Vein Hook
19.5 cm



Strandell-Stille

PSI-5-929-01

Strandell-Stille
19 cm Fig. 1, 19 cm Fig. 2

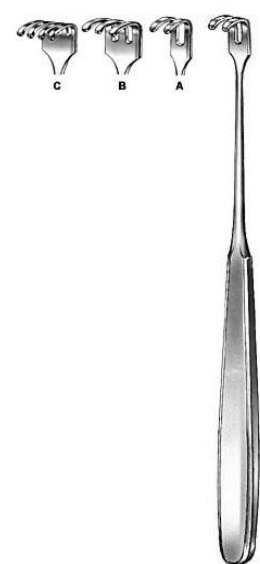

Klapp

PSI-5-930-01

Retractor 12 x 6, 12 x 11, 15 x 11
17.5 cm



Hooklet

PSI-5-931-04

Hooklet
16.5 cm

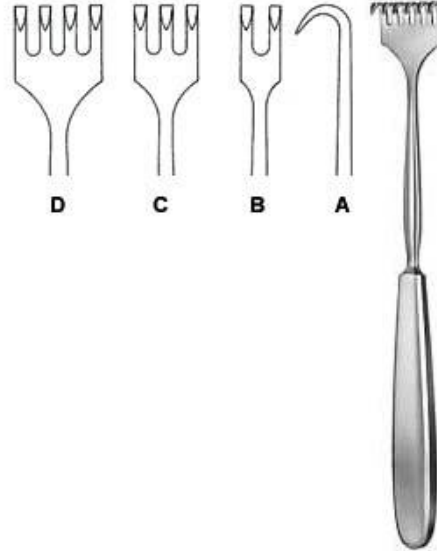

Volkman

PSI-5-932-01

Retractor
21.5 cm

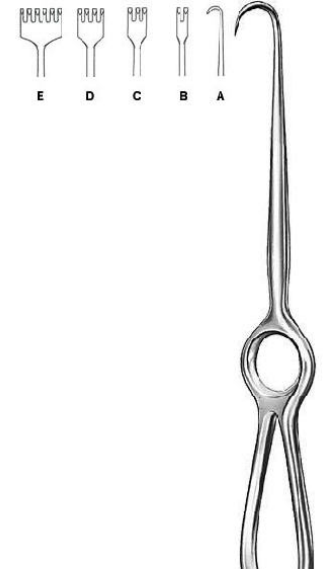

Volkman

PSI-5-933-01

Retractor
22 cm, 21.5 cm

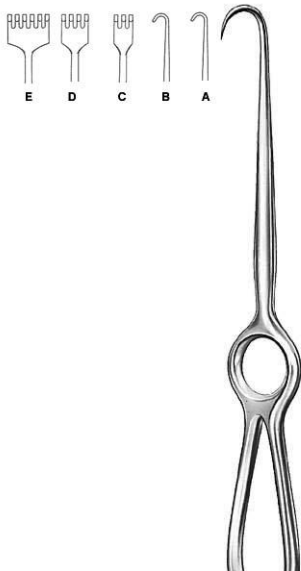

Kocher

PSI-5-934-01

Retractor
22 cm

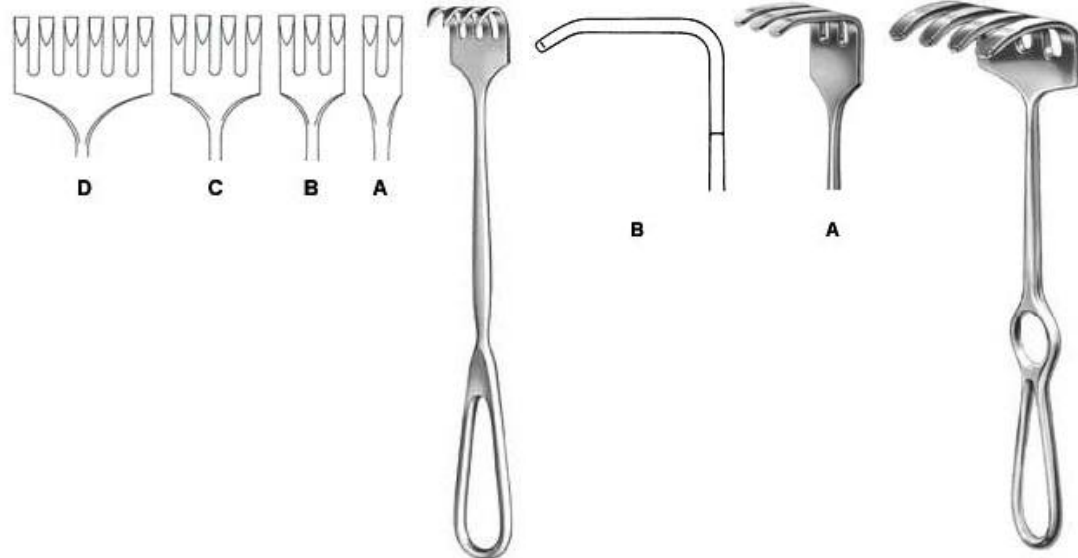

Martin

PSI-5-935-02

Retractor
22.5 cm

Ollier

PSI-5-936-03

Retractor
23 cm 36 x 30, 23 cm 36 x 60



Wassmund

PSI-5-937-02

Retractor
20.5 cm 33 x 21

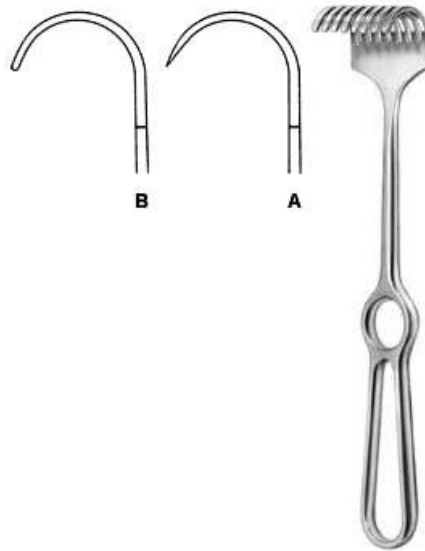

Korte

PSI-5-938-08

Retractor
24.5 cm 40 x 30

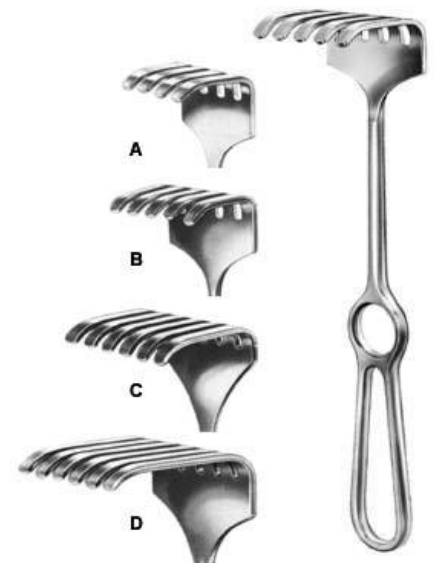

Israel

PSI-5-939-04

Retractor
25.5 cm

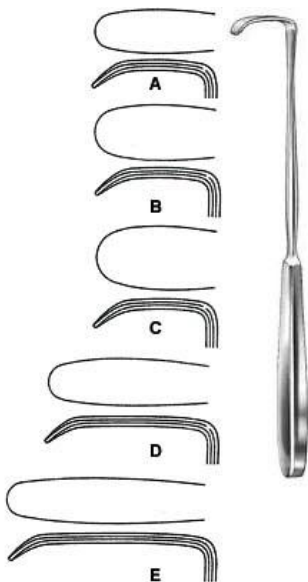

Langenbeck

PSI-5-940-01

Retractor
22.5 cm 30 x 11 mm, 22.5 cm 30 x 14 mm, 22.5
cm 30 x 16 mm, 22.5 cm 40 x 11 mm, 22.5 cm 50
x 11 mm

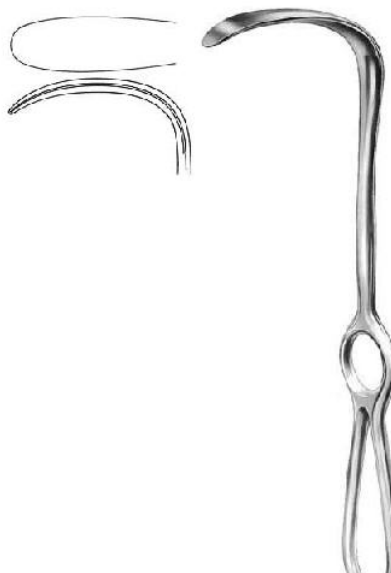

Langenbeck

PSI-5-942-21

Retractor
21 cm 65 x 20 mm

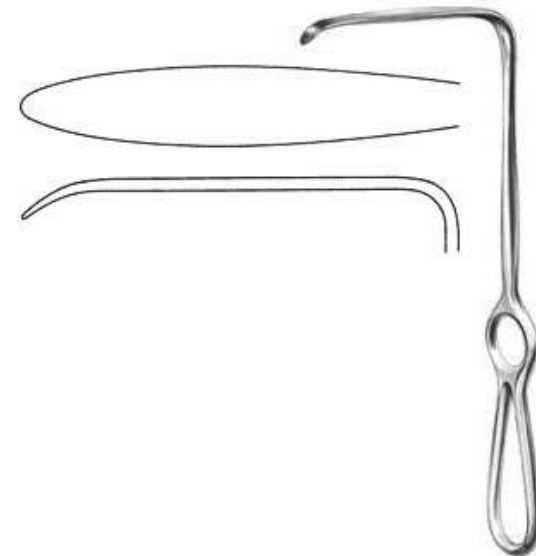

Langenbeck

PSI-5-943-21

Retractor
22.5 cm 85 x 15 mm



Lahey

PSI-5-944-19

Retractor

19.5 cm 36 x 19 mm



Little

PSI-5-945-20

Retractor

20 cm 13 x 15 mm

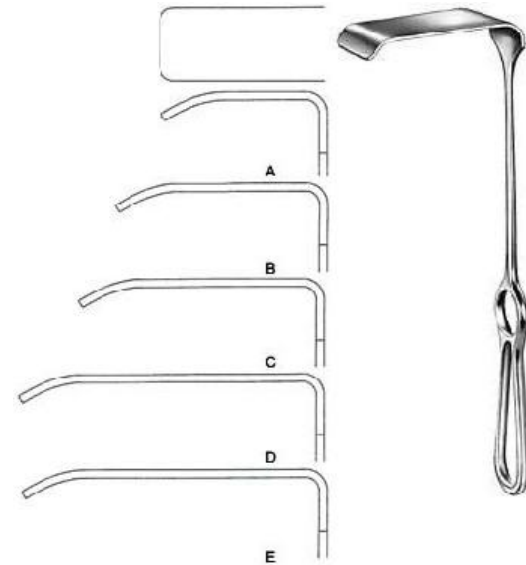

Kocher

PSI-5-946-18

Retractor

23 cm 43 x 18 mm, 23 cm 53 x 20 mm, 23 cm 63 x 25 mm, 23 cm 77 x 30 mm, 23 cm 78 x 40 mm

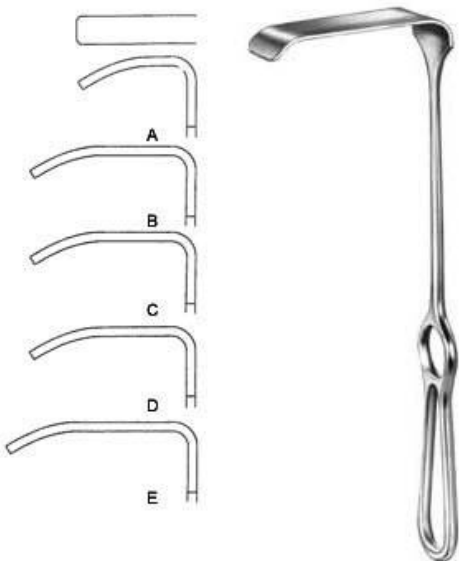

Kocher-Langenbeck

PSI-5-947-01

Retractor

21.5 cm 25 x 6 mm, 21.5 cm 35 x 8 mm, 21.5 cm 35 x 11 mm, 21.5 cm 35 x 15 mm, 21.5 cm 40 x 11 mm, 21.5 cm 55 x 11 mm, 21.5 cm 70 x 14 mm, 21.5 cm 80 x 12 mm

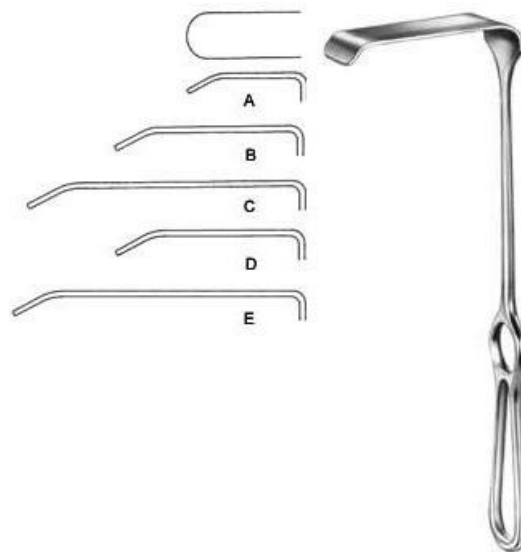

Kocher-Langenbeck

PSI-5-948-01

Retractor

21.5 cm 25 x 10 mm, 21.5 cm 40 x 13 mm, 21.5 cm 60 x 13 mm, 21.5 cm 40 x 18 mm, 21.5 cm 60 x 18 mm, 21.5 cm 85 x 18 mm, 21.5 cm 60 x 25 mm, 21.5 cm 85 x 25 mm

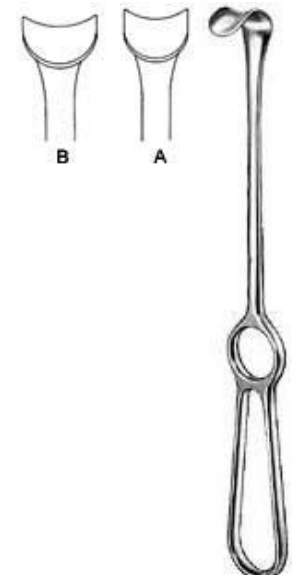

Kocher

PSI-5-949-01

Retractor

21.5 cm 22 x 12, 21.5 cm 24 x 14 mm

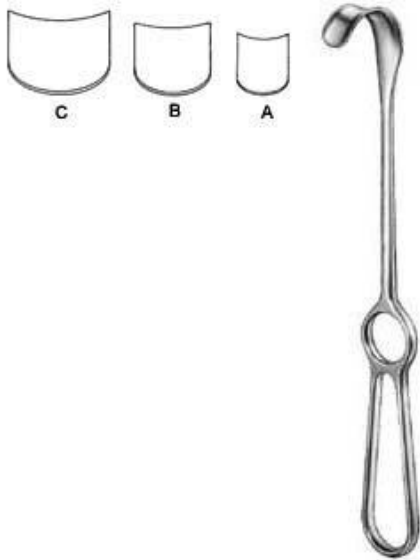

Kocher

PSI-5-950-01

Retractor

22 cm 42 x 10 mm, 22 cm 42 x 15 mm, 22 cm 43 x 20 mm

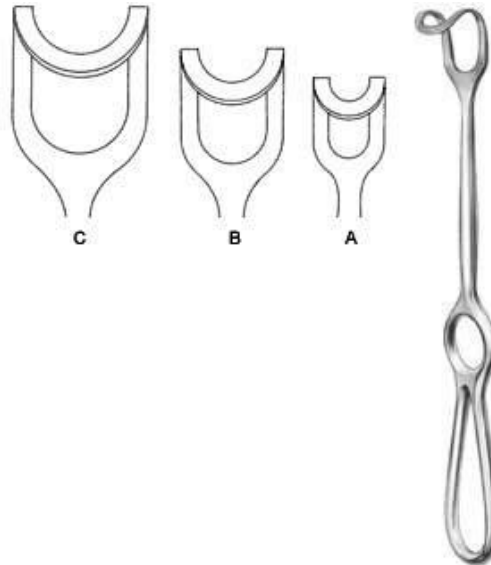

Middeldorpf

PSI-5-951-01

Retractor

21.5 cm 18 x 17 mm, 23 cm 25 x 22 mm, 24.5 cm 30 x 31 mm

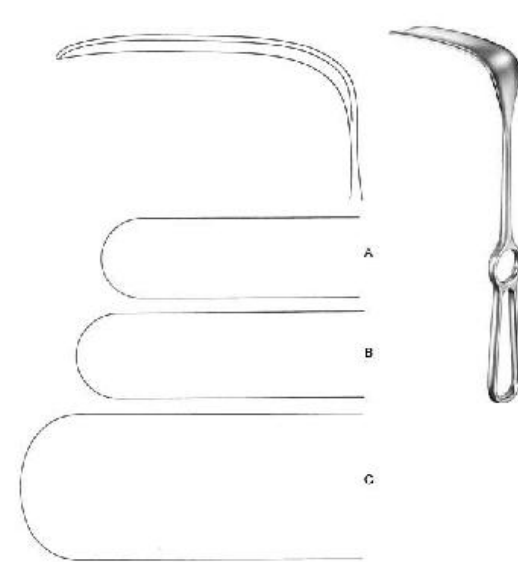

Doyen-Stille

PSI-5-952-01

Retractor

26 cm 97 x 29 mm, 26 cm 101 x 31 mm, 26 cm 127 x 52 mm

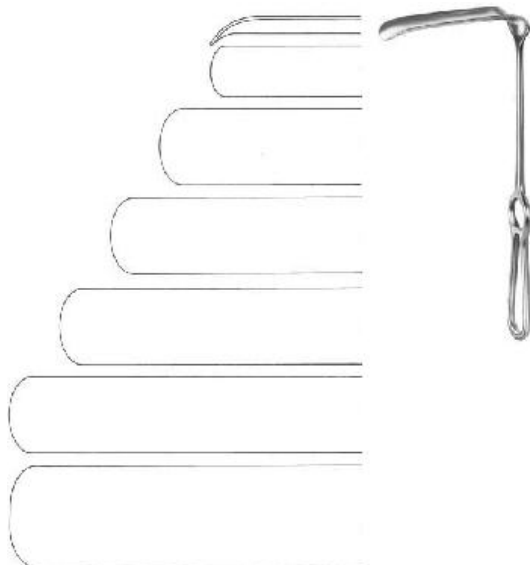

Hosel

PSI-5-953-01

Retractor

26 cm 63 x 21 mm, 26 cm 83 x 30 mm, 26 cm 103 x 30 mm, 26 cm 120 x 30 mm, 26 cm 140 x 30 mm, 26 cm 140 x 40 mm

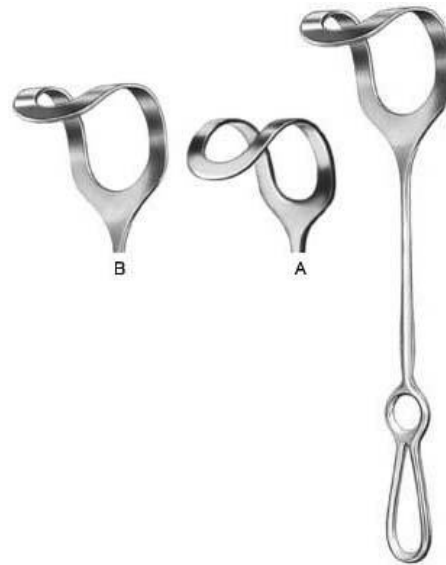

Middeldorpf

PSI-5-954-01

Retractor

27 cm 48 x 45 mm, 27 cm 52 x 50 mm, 27 cm 60 x 70 mm

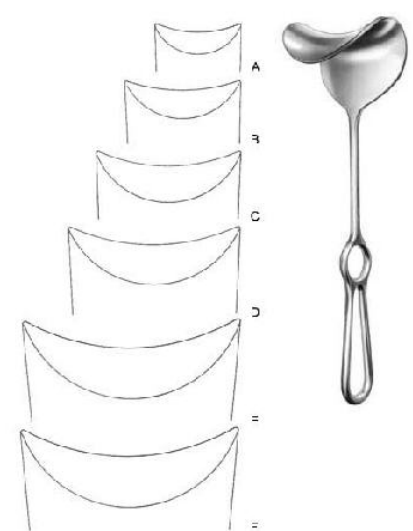

Fritsch

PSI-5-955-00

Retractor

23.5 cm 37 x 31 mm, 24 cm 38 x 40 mm, 25 cm 43 x 51 mm, 25 cm 49 x 61 mm, 25.5 cm 48 x 75 mm, 25.5 cm 65 x 85 mm



Doyen

PSI-5-956-25

Retractor
24 cm 48 x 88 mm



Kocher

PSI-5-957-22

Retractor
24 cm 73 x 25 mm



Kocher

PSI-5-958-01

Retractor
25 cm 80 x 45 mm, 25 cm 80 x 55 mm, 25 cm 80 x 65 mm



Martin

PSI-5-959-25

Retractor
26 cm 110 x 27 mm

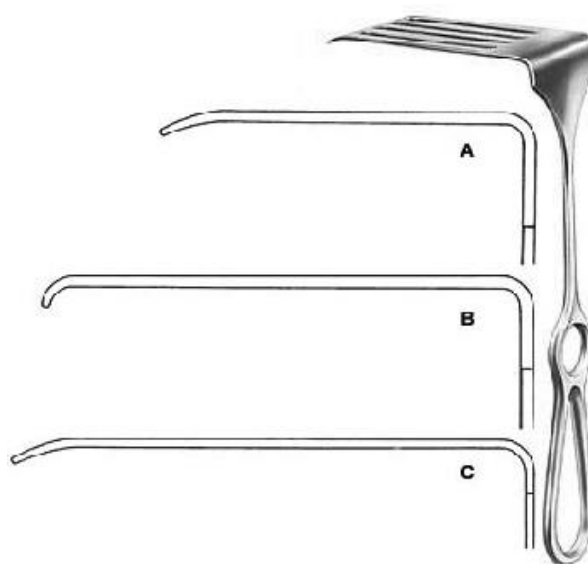

Coryllos

PSI-5-960-01

Retractor
24 cm 85 x 22 mm, 24 cm 108 x 43 mm, 24 cm 119 x 65 mm



Davidson

PSI-5-961-01

Retractor
19 cm 80 x 54 mm, 18.5 cm 80 x 95 mm

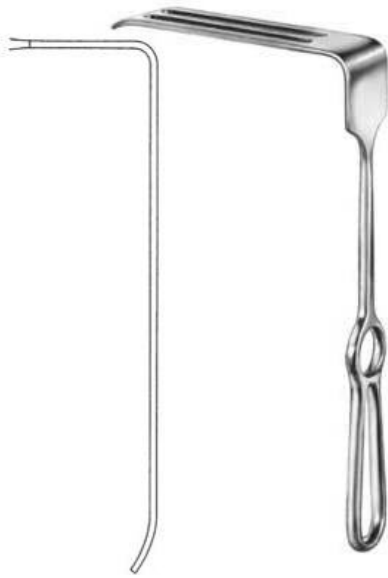

Sauerbruch

PSI-5-962-25

Retractor

25.5 cm 127 x 38 mm

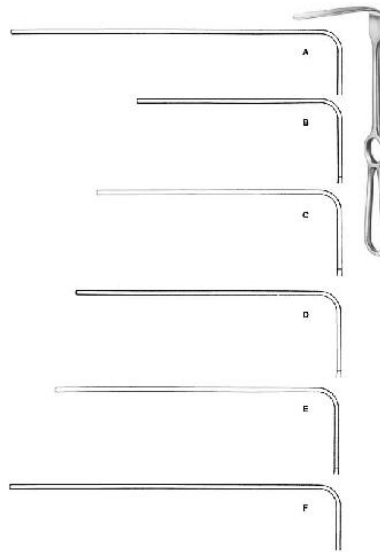

Brunner

PSI-5-963-08

Retractor

25.5 cm 84 x 20 mm, 25.5 cm 104 x 25 mm, 25.5 cm 124 x 30 mm, 25.5 cm 130 x 30 mm, 25.5 cm 144 x 30 mm, 25.5 cm 160 x 30 mm, 25.5 cm 164 x 30 mm

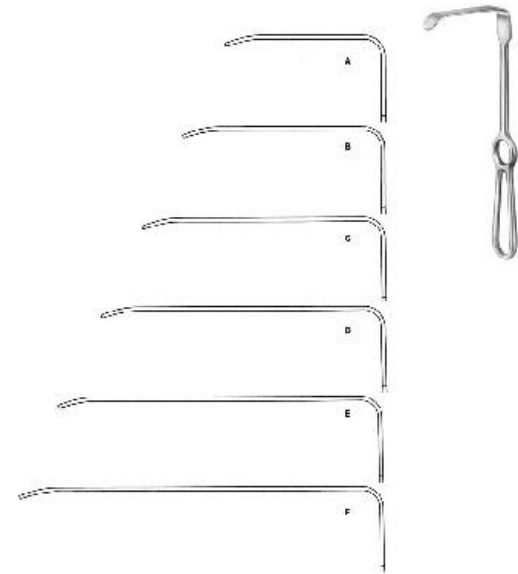

Brunner

PSI-5-964-08

Retractor

25.5 cm 82 x 20 mm, 25.5 cm 102 x 20 mm, 25.5 cm 122 x 25 mm, 25.5 cm 140 x 25 mm, 25.5 cm 162 x 30 mm, 25.5 cm 182 x 30 mm

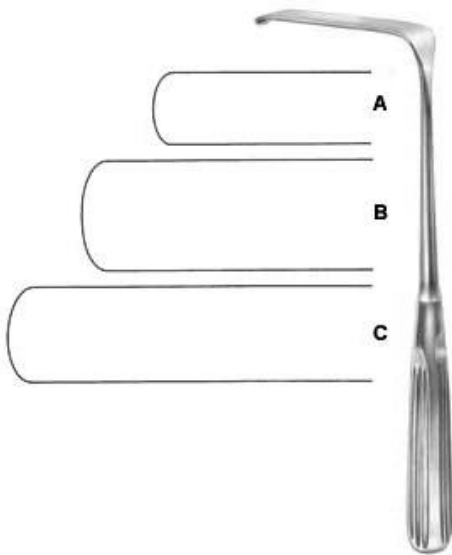

Sauerbruch

PSI-5-965-01

Retractor

22.5 cm 50 x 15 mm, 22.5 cm 63 x 23 mm, 22.5 cm 80 x 20 mm



Deaver

PSI-5-966-01

Retractor

18 cm 19 mm

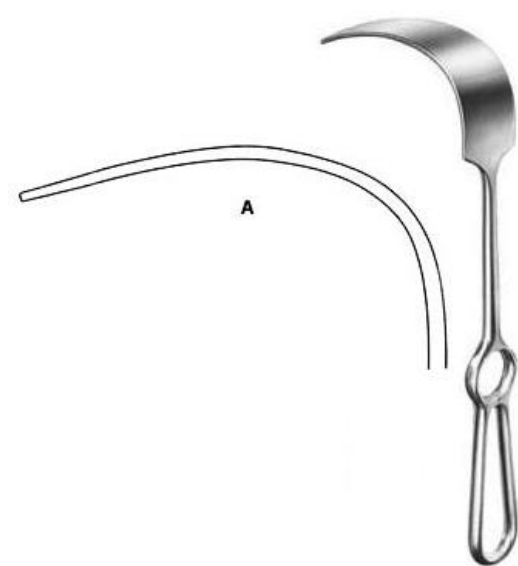

Mikulicz

PSI-5-968-01

Retractor

25 cm 90 x 35 mm, 25 cm 125 x 50 mm, 25 cm 160 x 50 mm



Mikulicz

PSI-5-969-26

Retractor

26 cm 90 x 55 mm

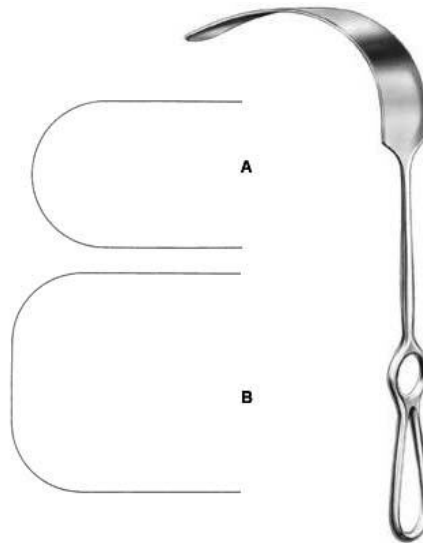

Kelly

PSI-5-970-01

Retractor

27.5 cm 205 x 38 mm, 27.5 cm 205 x 57 mm



Farabeuf

PSI-5-971-00

Retractor

15 cm Fig. 1 = 23 x 16, 15 cm Fig. 1 = 26 x 16, 15 cm Fig. 2 = 27 x 16, 15 cm Fig. 2 = 30 x 16

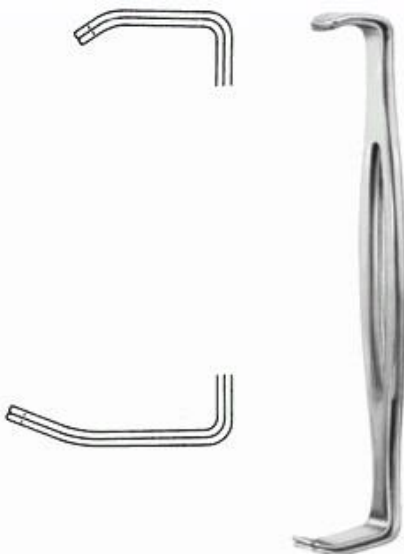

Parker-Langenbeck

PSI-5-972-00

Retractor

21.5 cm Fig. 1 = 21x15 mm, 21.5 cm Fig. 1 = 40x15 mm, 21.5 cm Fig. 2 = 25x15 mm, 21.5 cm Fig. 2 = 45x15 mm



Alm

PSI-5-973-07

Wound Spreaders, self-retaining

7 cm



Alm

PSI-5-974-07

Wound Spreaders, self-retaining

7 cm



Gosset

PSI-5-975-22

Abdominal Retractor
18.5 cm



Balfour-Baby

PSI-5-976-00

Abdominal Retractor spreading 90mm, 1 central
blade 24 x 20 mm
12.5 cm



Balfour

PSI-5-977-00

Abdominal retractor spreading 180 mm, lateral
blades 70 x 35 mm, 1 central blade
20 cm

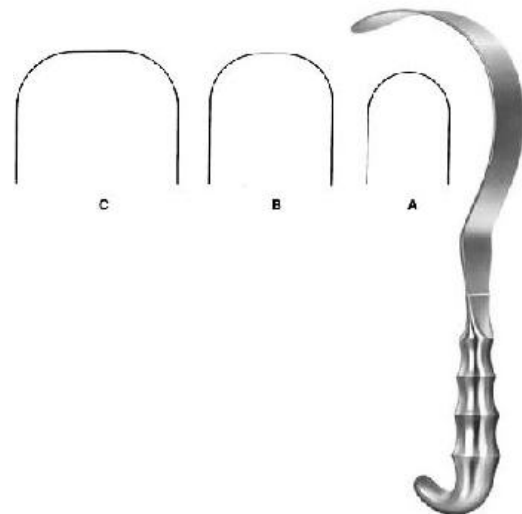

Deaver

PSI-5-967-04

Retractor

31.5 cm 25 mm, 31.5 cm 38 mm, 31.5 cm 50 mm,
31.5 cm 100 mm



Probe

PSI-5-1001-11

Probe

11.5cm, 13 cm , 14.5 cm , 16 cm, 18 cm, 20cm, 25 cm , 30 cm



Probe

PSI-5-1002-11

Probe

11.5 cm, 13 cm , 14.5 cm , 16 cm, 18 cm, 20cm, 25 cm , 30 cm



Probe

PSI-5-1003-13

Probe

13 cm , 14.5 cm , 16 cm, 18 cm, 20 cm, 25 cm



Probe With Eye

PSI-5-1004-13

Probe with eye

13 cm , 14.5 cm , 16 cm

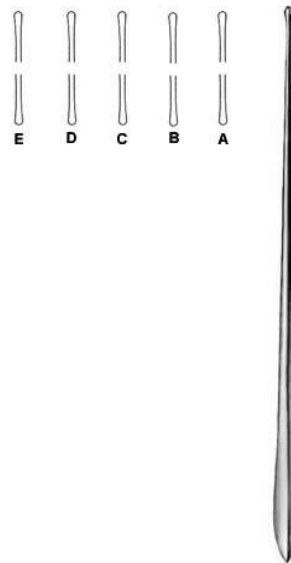

Myrtle Leaf Probe

PSI-5-1006-13

Myrtle Leaf Probe

13 cm , 14.5 cm , 16 cm, 18 cm, 20 cm



Grooved Director

PSI-5-1007-13

Grooved Director

13 cm , 14 cm, 16 cm



Grooved Director

PSI-5-1008-13

Grooved Director
13 cm , 14.5 cm , 16 cm



Doyen

PSI-5-1009-14

Grooved Director
14.5 cm



Nelaton

PSI-5-1010-16

Grooved Director
16 cm

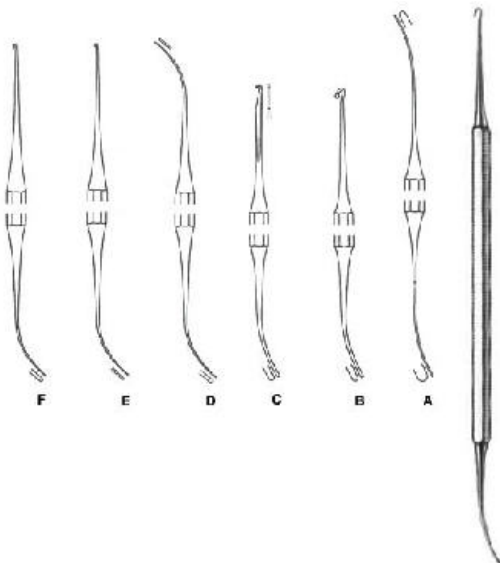

Varady

PSI-5-1011-01

Phlebotomizer
18 cm, 17.5 cm

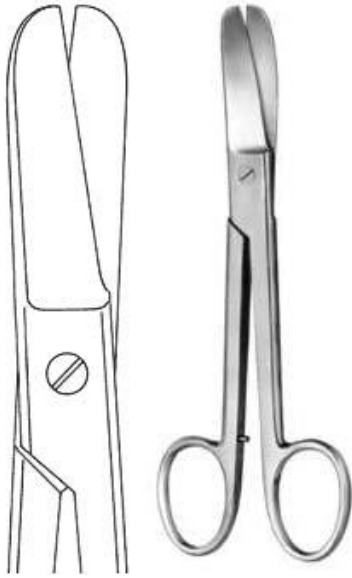

Lorenz

PSI-6-101-23

Bandage Scissors heavy pattern
23 cm

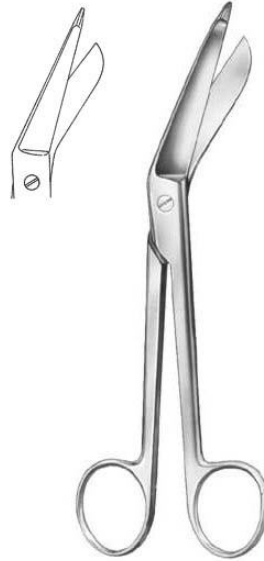

Lister

PSI-6-102-14

Bandage Scissors
14.5 cm , 18.5 cm , 20 cm



Bergmann

PSI-6-103-23

Plaster Shears
23.5 cm



Esmarch

PSI-6-104-20

Plaster Shears heavy pattern, short blades
20 cm



**Bandage Scissors Black Plastic Ring
With Autodavable**

PSI-6-105-15

Bandage Scissors black plastic ring with
autodavable
16 cm, 19 cm



Bandage Scissors Black Plastic Rings

PSI-6-106-18

Bandage Scissors black plastic rings
16 cm, 19 cm

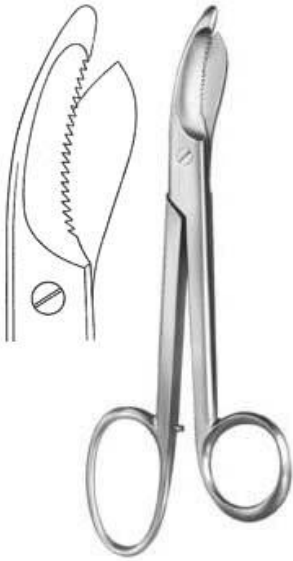

Bruns

PSI-6-107-24
Plaster Scissors
24 cm

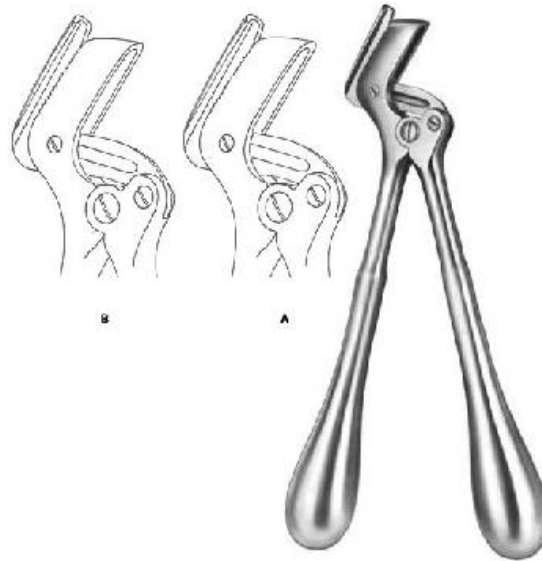

Stille-Martin

PSI-6-108-23
Plaster Shears
23 cm , 27 cm, 38 cm

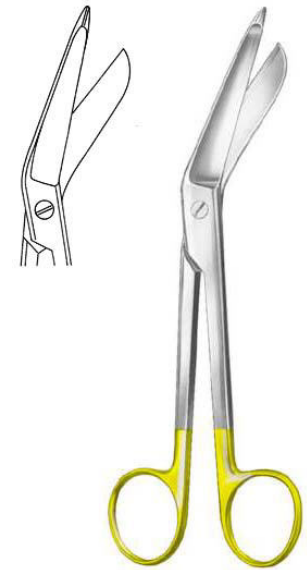

Lister

PSI-6-109-18
Bandage Scissors
18 cm

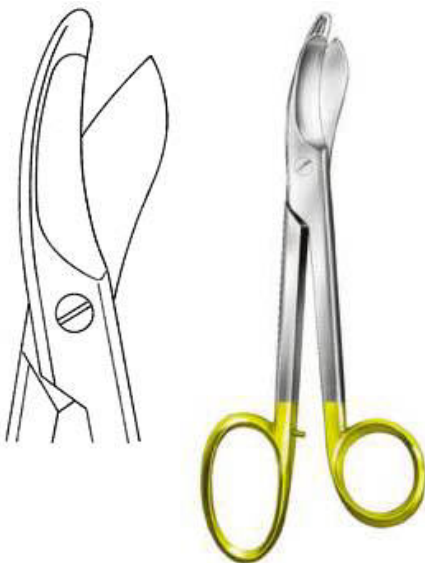

Bruns

PSI-6-110-24
Plaster Scissors
24 cm



Hopkins

PSI-6-111-20
Plaster Knife with wooden handle
20 cm



Reiner

PSI-6-112-18
Plaster Knife
18 cm



Reiner

PSI-6-113-18

Plaster Knife
18 cm



Martin

PSI-6-114-21

Plaster Knife with wooden handle
21 cm



Engel

PSI-6-115-14

Plaster Saw
15.5 cm

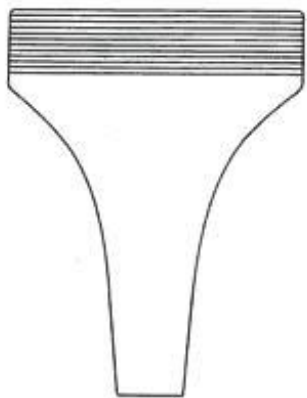

Hennig

PSI-6-116-28

Plaster Spreader
28 cm



Wolff

PSI-6-117-18

Plaster Breaker
18 cm, 26.5 cm



B



A





Gigli

PSI-8-101-01

Wire Saw Handle



De Martel

PSI-8-102-33

Wire Saw Guide
33 cm



Crutchfield

PSI-8-103-01

Skull Traction Tong small pattern



Skull Traction Tong Large Pattern

PSI-8-104-01

Skull Traction Tong large pattern
22.5 cm



Dahlgren

PSI-8-105-20

Cranial Rongeur
20 cm



Olivecrona-Toennis

PSI-8-106-14

Clip Applying Forceps



McKenzie

PSI-8-107-19

Clip Applying Forceps
18.5 cm



Olivecrona

PSI-8-108-18

Dura Dissector
18 cm



Olivecrona

PSI-8-109-19

Dura Dissector
20 cm



Milligan

PSI-8-110-21

Dura Dissector
21.5 cm



Davis

PSI-8-111-21

Dura Dissector sharp
21.5 cm



Dura Dissector

PSI-8-112-22

Dura Dissector
22 cm



Davis

PSI--8-113

Dura Dissector
24.5 cm



Love

PSI-8-114-19

Nerve Root Retractor
21.5 cm, 18 cm, 11 cm



Olivecrona

PSI-8-115-18

Brain Spatula
18 cm



Scoville

PSI-8-116-23

Nerve Root Retractor 8mm
23.5 cm



Holsher

PSI-8-117-24

Nerve Root Retractor 8mm
23.5 cm

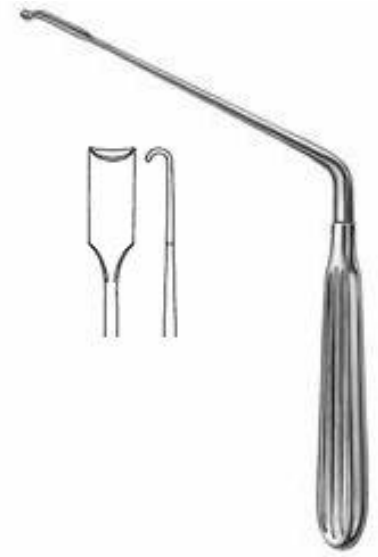

Scoville

PSI-8-118-19

Nerve Root Retractor 7mm
16.5 cm



Groningen

PSI-8-119-26

Nerve Hook
26.5 cm



Groningen

PSI-8-120-26

Nerve Hook
26.5 cm



Cushing

PSI-8-121-19

Nerve Hook blunt
19 cm , 28 cm

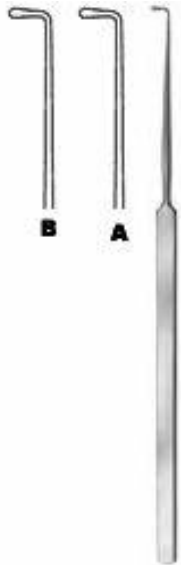

Cushing

PSI-8-122-19

Nerve Hook
19.5 cm , 28 cm



Smithwick

PSI-8-123-17

Smithwick
17 cm , 21 cm



Halle

PSI-8-125-20

Dura Knife
20 cm



Adson
PSI-8-126-20
Dura Hook
20 cm



Graham
PSI-8-127-16
Dura Hook blunt
16.5 cm



Sachs
PSI-8-128-18
Dura Hook sharp
18 cm



Toennis
PSI-8-129-15
Dura Hook sharp
14.5 cm



Frazier
PSI-8-130-13
Dura Hook sharp
13 cm , 18 cm



Krayenbuhl
PSI-8-131-01
Nerve and Vessel Hooklet
18.5 cm Fig. 1 , 18.5 cm Fig. 2



Cloward

PSI-8-132-16

Lamina Spreader
16 cm

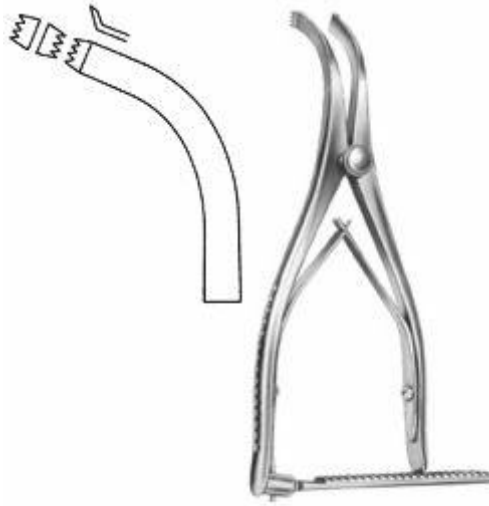

Inge

PSI-8-133-17

Lamina Spreader
16 cm

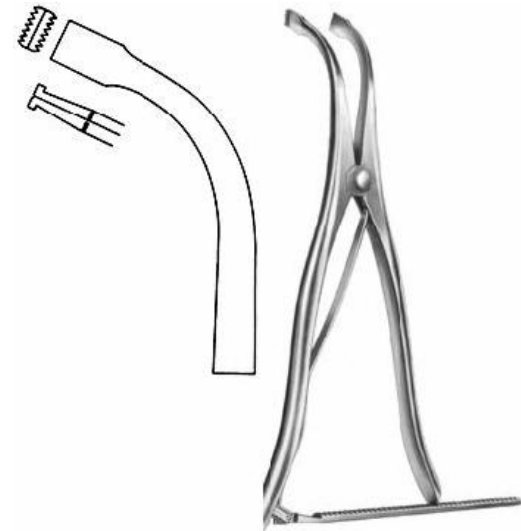

Inge

PSI-8-134-27

Lamina Spreader
25.5 cm

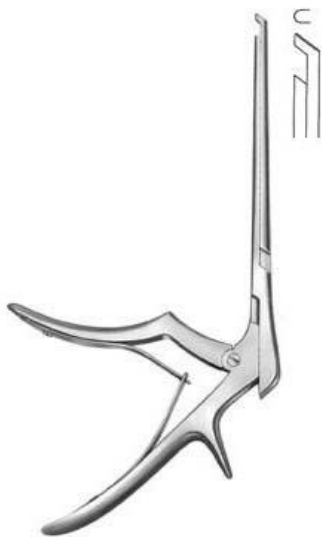

Ferris-Smith Kerrison

PSI-8-135-03

Laminectomy Punch 3mm downwards cutting 40
degree shaft length 180 mm

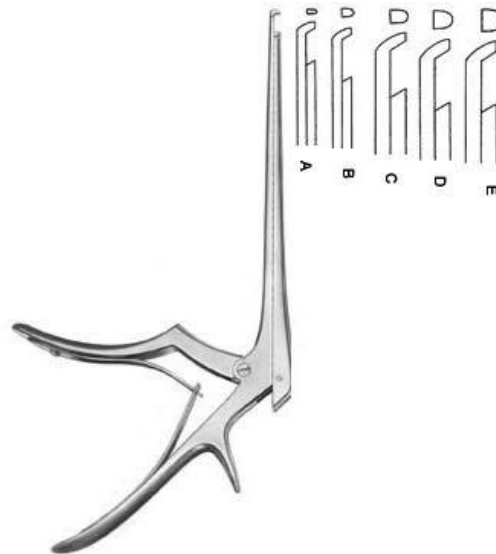

Ferris-Smith Kerrison

PSI-8-138-01

Laminectomy Punch upwards cutting shaft length
180 mm
1 mm, 2 mm, 3 mm, 4 mm, 5 mm, 6 mm

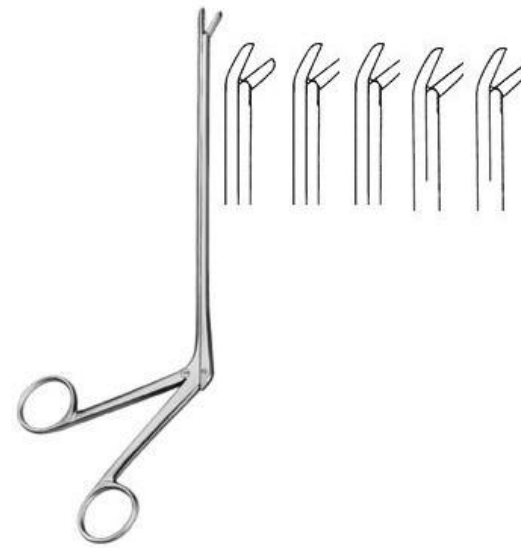

Cushing

PSI-8-139-01

Laminectomy Rongeur jaw 2 x 10 to 4 x 10 mm
straight shaft length 180 mm

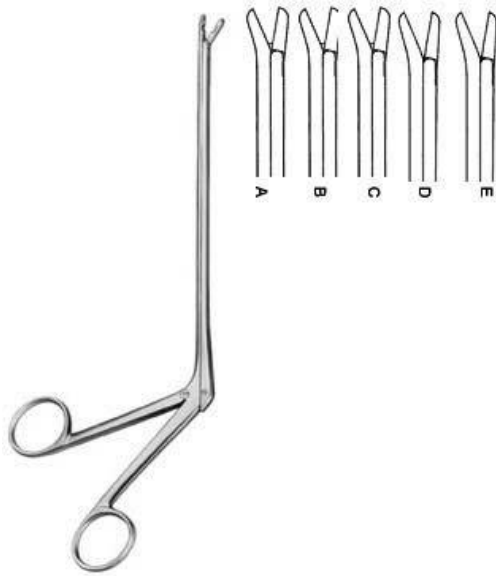

Cushing

PSI-8-140-01

Laminectomy Rongeur jaw 2 x 10 to 4 x 10 mm upwards 45 degree shaft
length 120 mm



Ferris-Smith Kerrison

PSI-8-137-01

Laminectomy Punch
1 mm, 2 mm, 3 mm, 4 mm, 5 mm, 6 mm



Bone Shear

PSI-9-101-23

Bone Shear
23 cm



Rib Shear

PSI-9-102-22

Rib Shear
23 cm



Gluck

PSI-9-103-22

Rib Shears
21 cm



Giertz-Stillle

PSI-9-104-27

Rib Shear
24.5 cm



Lebsche

PSI-9-105-24

Sternum Chisel
24.5 cm



Rib Retractor

PSI-9-106-01

Rib Retractor lateral blades 12 x 16 mm spreading 95
mm

Size 1



Finochietto, Infant

PSI-9-107-01

Rib Retractor lateral blades 15 x 15 mm spreading

75 mm

Size 1



Finochietto, Baby

PSI-9-108-01

Rib Retractor lateral blades 31 x 31 mm spreading

100 mm

Size 1



Finochietto

PSI-9-109-01

Rib Retractor lateral blades 40 x 45 mm spreading

135 mm

Size 1



Burford

PSI-9-110-01

Rib Retractor with two pairs of blades 47 x 62 mm +

65 x 62 mm, spreading 200 mm

Size 1



Castaneda

PSI-9-111-01

Rib Retractor lateral blades 10,5 x 32 mm spreading

65 mm

Size 1



Finochietto (Modif.)

PSI-9-112-01

Rib Retractor lateral blades 14 x 15 mm spreading

120 mm

Size 1



Haight

PSI-9-113-90

Rib Retractor lateral blades 30 x 30 mm spreading

120 mm

Size 1



Morse-Favaloro

PSI-9-114-01

Sternal Retractor 4 movable blades 17 x 22 mm

spreading 160 mm Sternal Retractor

Size 1



Morse

PSI-9-115-00

Sternal Retractor 4 movable blades 22 x 27 mm

spreading 200 mm

Size 1



Tuffier

PSI-9-116-02

Rib Retractor lateral blades 22 x 27 mm spreading

200 mm

Size 1

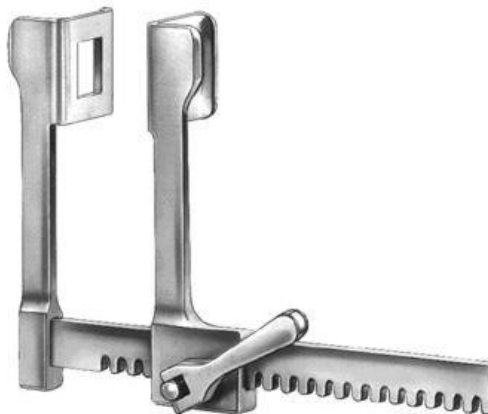

Finochietto, Baby

PSI-9-117-75

Rib Retractor lateral blades 14 x 15 mm spreading

75 mm

Size 1



Finochietto

PSI-9-118-01

Rib Retractor lateral blades 30 x 45 mm spreading

150 mm

Size 1



DeBakey

PSI-9-119-00

Rib Retractor spreading 150 mm
Size 1



DeBakey

PSI-9-120-00

Rib Retractor spreading 200 mm
Size 1



Thoracic Retractor

PSI-9-121-00

Thoracic Retractor
Size 1



Sellors

PSI-9-121-00

Rib Contractor
20 cm



Bailey-Baby

PSI-9-123-14

Rib Contractor
15.5 cm



Bailey

PSI-9-124-16

Rib Contractor
20 cm



Bailey-Gibbon

PSI-9-125-16
Rib Contractor
20 cm



Allison

PSI-9-126-30
Lung Spatula
29.5 cm, 32.5 cm

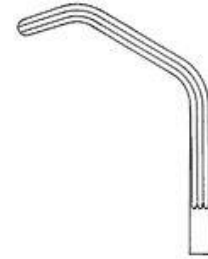

Price-Thomas

PSI-9-127-22
Bronchus Clamp
22 cm

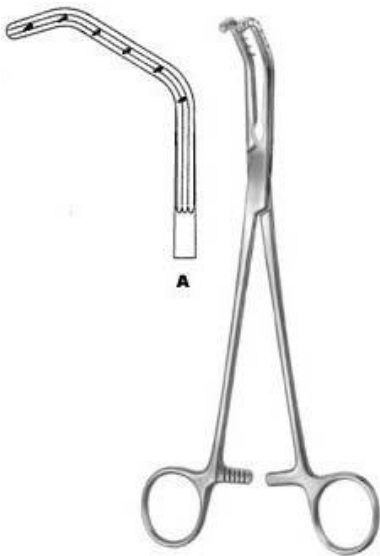

Price-Thomas

PSI-9-128-22
Bronchus Clamp
22 cm

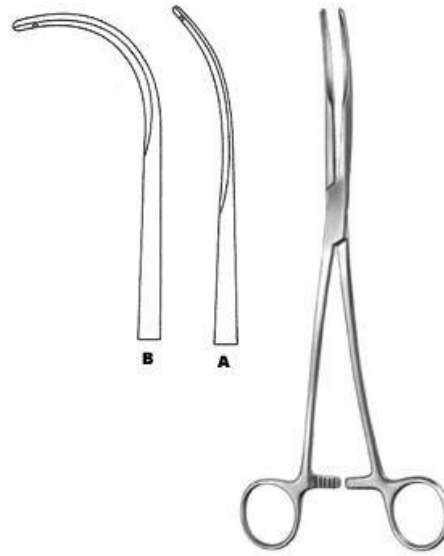

Semb

PSI-9-129-24
Bronchus Clamp
24.5 cm



Lovlace

PSI-9-130-20
Lung Grasping Forceps
20.5 cm

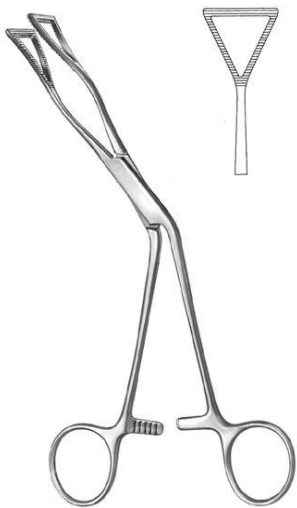

Lovelace

PSI-9-131-20

Lung Grasping Forceps
19 cm



DeBakey-Satinsky

PSI-9-132-07

Bulldog Clamp
7", 9 cm



Glover

PSI-9-133-06

Bulldog Clamp
6 cm



Santulli

PSI-9-134-07

Bulldog Clamp
7



Gregory, Soft

PSI-9-135-09

Bulldog Clamp
9 cm, 11 cm



Gregory

PSI-9-136-01

Bulldog Clamp
10.5 cm

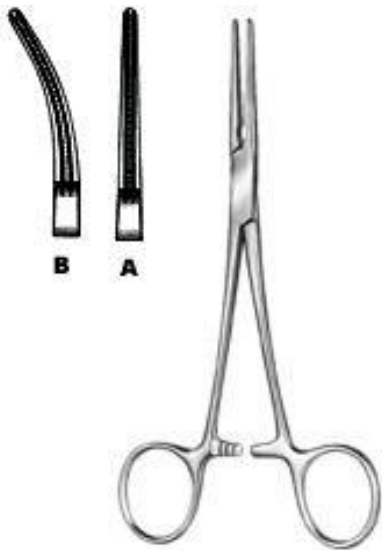

DeBakey-Rankin

PSI-9-137-16

Haemostatic Forceps

16 cm



DeBakey-Mosquito

PSI-9-138-15

Haemostatic Forceps

15 cm



Ochsner

PSI-9-139-23

Aortic Clamp

23.5 cm



Diethrich

PSI-9-140-21

Aortic Clamp

22 cm

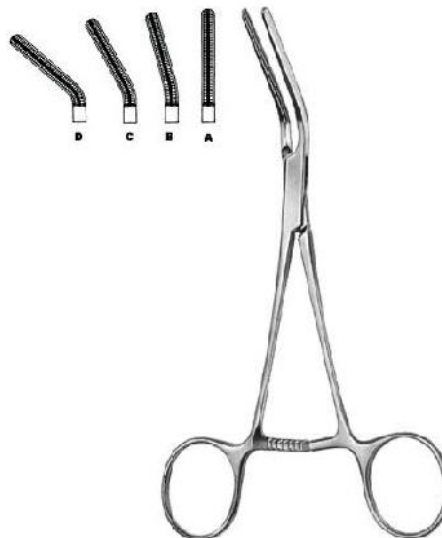

Dardik

PSI-9-141-00

Multi purpose Vascular Clamp

15 cm



Dale

PSI-9-142-18

Peripheral Vascular Clamp

18 cm

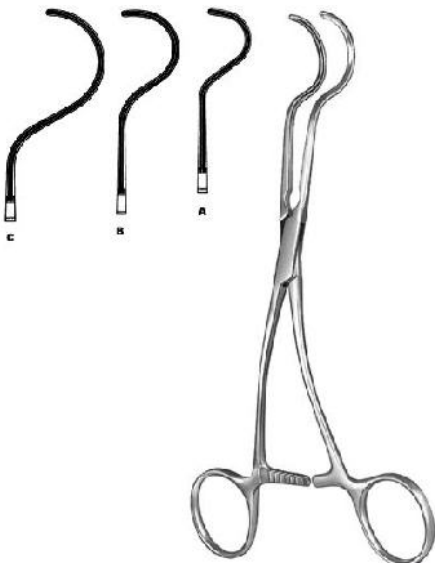

Dale

PSI-9-143-17

Peripheral Vascular Clamp
17.5 cm

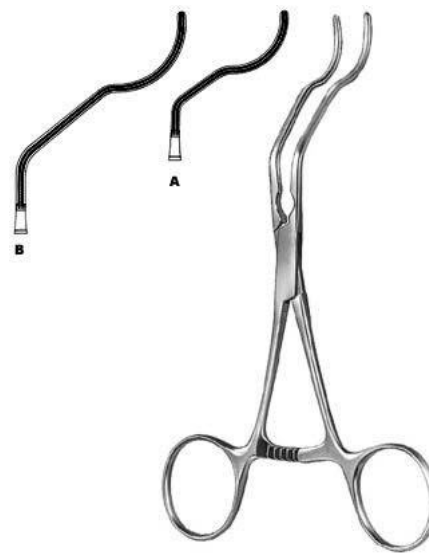

Gregory

PSI-9-144-14

Profunda Clamp
13 cm, 16 cm, 18 cm

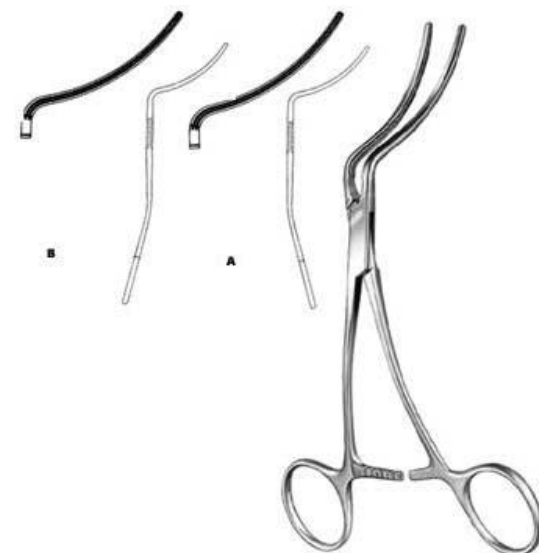

Martin

PSI-9-145-16

Peripheral Vascular Clamp
16.5 cm



Husfeldt

PSI-9-146-18

Peripheral Vascular Clamp
17.5 cm



Husfeldt

PSI-9-147-18

Peripheral Vascular Clamp
18 cm

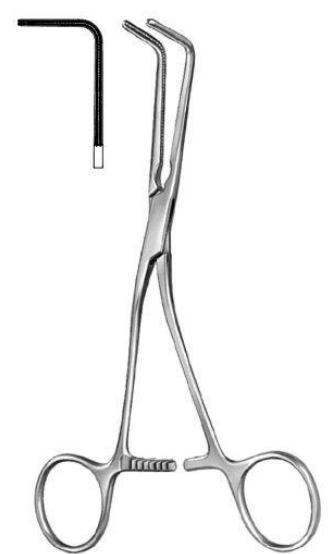

Husfeldt

PSI-9-148-17

Peripheral Vascular Clamp
17 cm

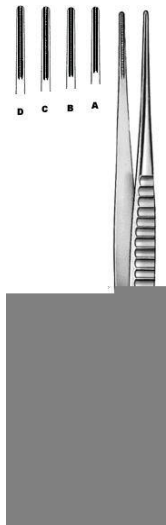

DeBakey

PSI-9-149-16

Vascular Forceps
16 cm



DeBakey

PSI-9-150-16

Vascular Forceps
16 cm



DeBakey

PSI-9-151-16

Vascular Forceps
16 cm

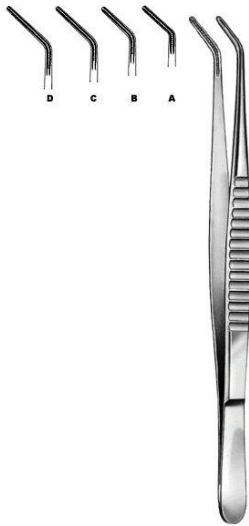

DeBakey

PSI-9-152-16

Vascular Forceps
16 cm



DeBakey

PSI-9-153-16

Vascular Forceps
16 cm



DeBakey

PSI-9-154-07

Bulldog Clamp
7



DeBailey

PSI-9-155-07

Bulldog Clamp

7



Applying Forceps

PSI-9-156-23

Applying Forceps

23.5 cm

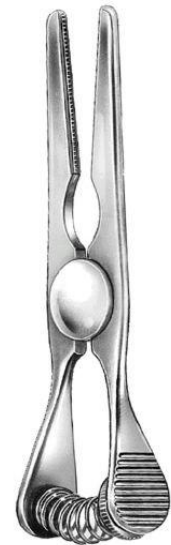

Glover

PSI-9-157-06

Bulldog Clamp

7



Glover

PSI-9-158-06

Bulldog Clamp

6.5 cm

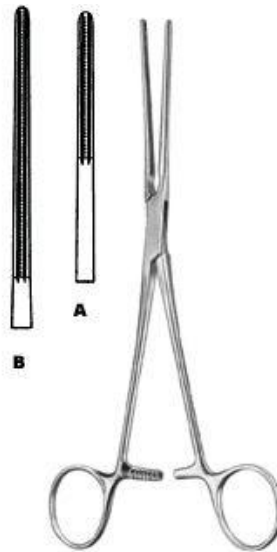

Potts

PSI-9-159-21

Coarctation Clamp

21 cm

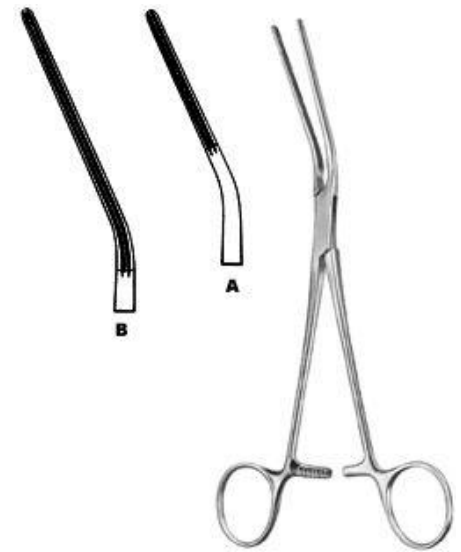

Potts

PSI-9-160-21

Coarctation Clamp

20.5 cm

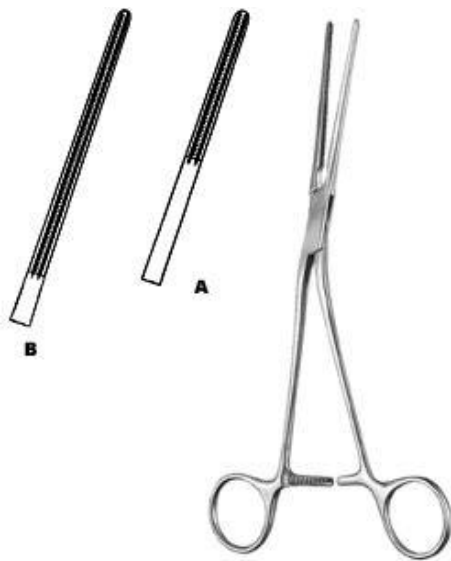

Potts
PSI-9-161-21
Coarctation Clamp
20.5 cm



Potts
PSI-9-162-22
Anastomosis Clamp
21.5 cm



Potts
PSI-9-163-22
Anastomosis Clamp
22 cm

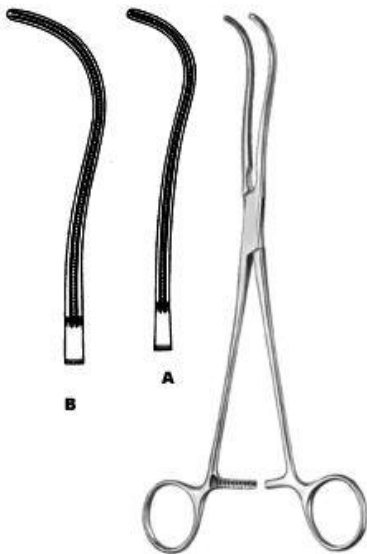

DeBakey
PSI-9-164-19
Ligature Forceps
19 cm



DeBakey
PSI-9-165-16
Peripheral Vascular Clamp
16 cm



DeBakey
PSI-9-166-19
Peripheral Vascular Clamp
16 cm

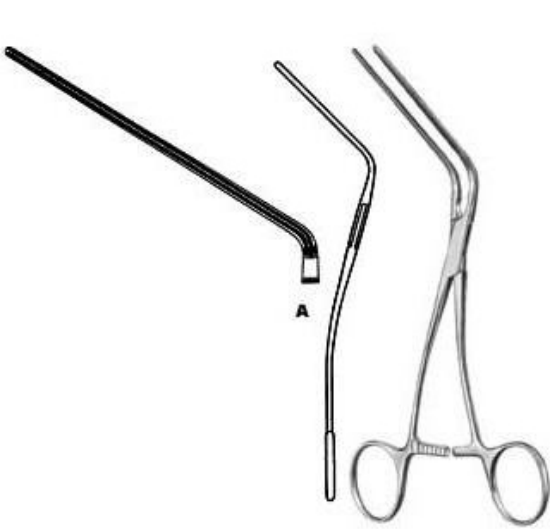

Leland-Jones

PSI-9-167-18

Peripheral Vascular Clamp
18 cm



Bainbridge

PSI-9-168-15

Multi purpose Vascular Clamp
15 cm

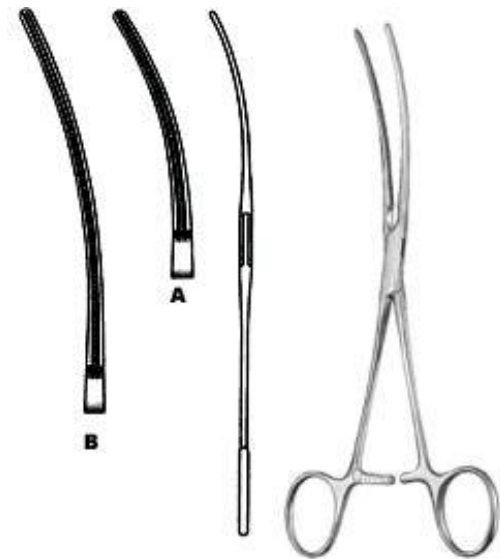

Bainbridge

PSI-9-169-15

Multi purpose Vascular Clamp
15 cm

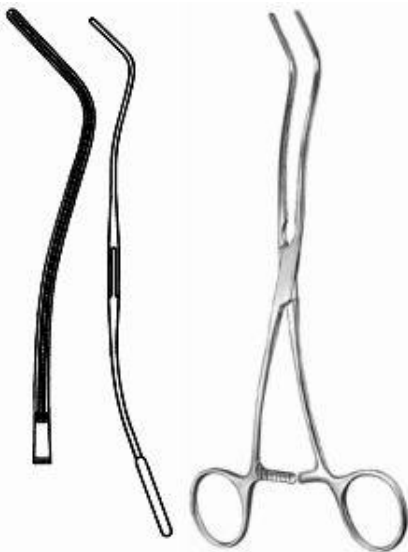

DeBakey

PSI-9-170-20

Multi purpose Vascular Clamp
20 cm



DeBakey

PSI-9-171-26

Aortic Aneurysm Clamp
26 cm



DeBakey

PSI-9-172-28

Aortic Aneurysm Clamp
28 cm



DeBakey

PSI-9-173-30

Aortic Aneurysm Clamp
30 cm



DeBakey

PSI-9-174-27

Aortic Clamp
27 cm



DeBakey

PSI-9-175-24

Ligature Forceps
24.5 cm



DeBakey

PSI-9-176-24

Ligature Forceps
24.5 cm



DeBakey

PSI-9-178-25

Ligature Forceps
27 cm

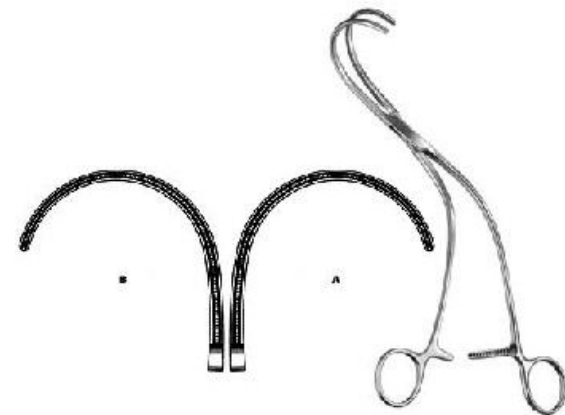

Weber

PSI-9-179-01

Aortic Clamp
24 cm



Satinsky

PSI-9-180-20

Tangential Occlusion Clamp
22 cm



Harken

PSI-9-181-01

Auricle Clamp
24.5 cm



Lees

PSI-9-182-23

Bronchus Clamp
23 cm



Lees

PSI-9-183-25

Bronchus Clamp
25 cm



Lambert-Kay

PSI-9-184-21

Anastomosis Clamp
22.5 cm



DeBakey

PSI-9-185-17

Anastomosis Clamp
16.5 cm



Morris-DeBakey

PSI-9-186-18

Aortic Clamp
16.5 cm



DeBakey-Bahnson

PSI-9-187-23

Aneurysm Clamp
23.5 cm

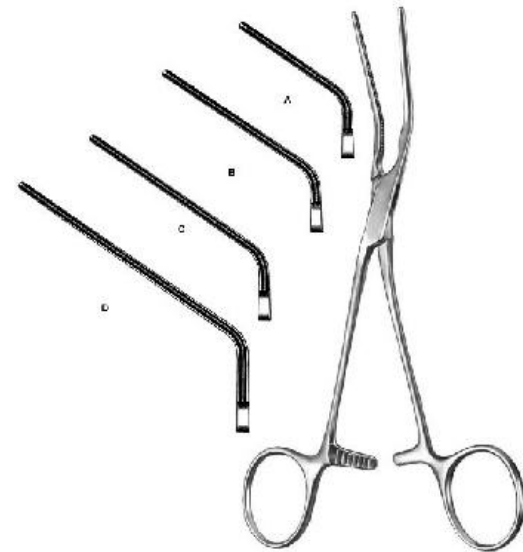

DeBakey

PSI-9-188-20

Multi purpose Vascular Clamp
18 cm

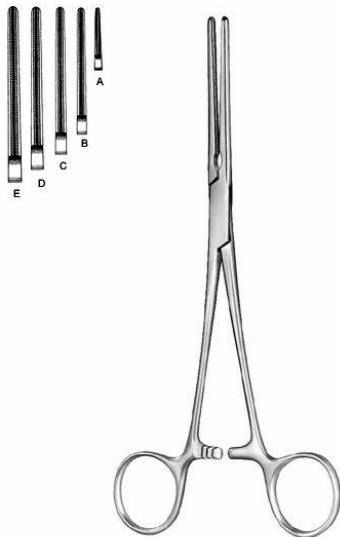

DeBakey-Mosquito

PSI-9-189-12

Haemostatic Forceps
12.5 cm

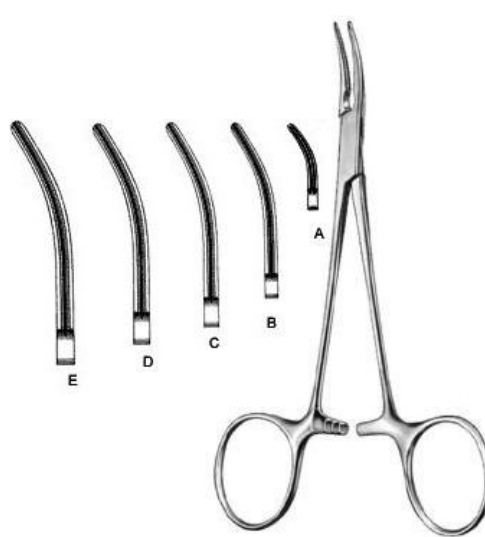

DeBakey-Mosquito

PSI-9-190-12

Haemostatic Forceps
12.5 cm



DeBakey

PSI-9-191-17

Multi purpose Vascular Clamp
17 cm



DeBakey

PSI-9-192-16

Multi purpose Vascular Clamp
16.5 cm

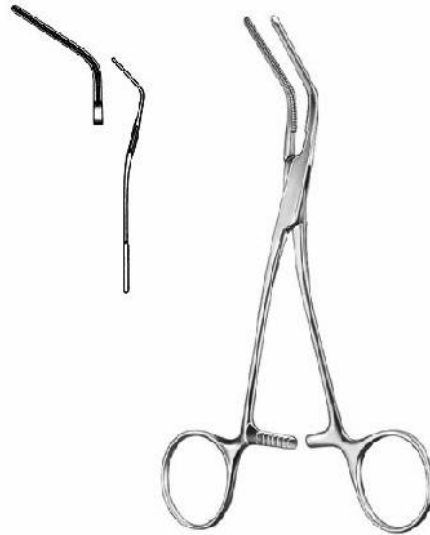

DeBakey

PSI-9-193-15

Multi purpose Vascular Clamp
16 cm

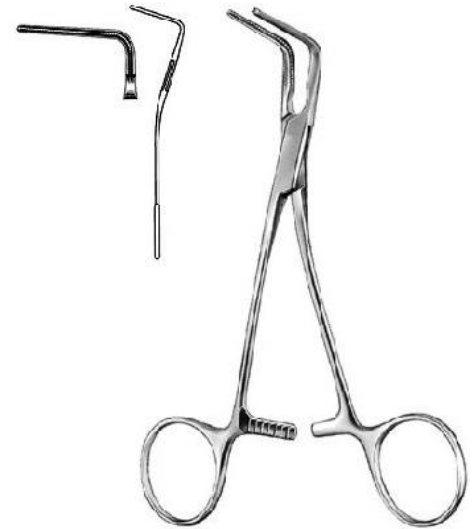

DeBakey

PSI-9-194-15

Multi purpose Vascular Clamp
16.5 cm



DeBakey

PSI-9-195-17

Multi purpose Vascular Clamp
16.5 cm



Glover

PSI-9-196-17

Multi purpose Vascular Clamp
17 cm



Glover

PSI-9-197-17

Multi purpose Vascular Clamp
17.5 cm

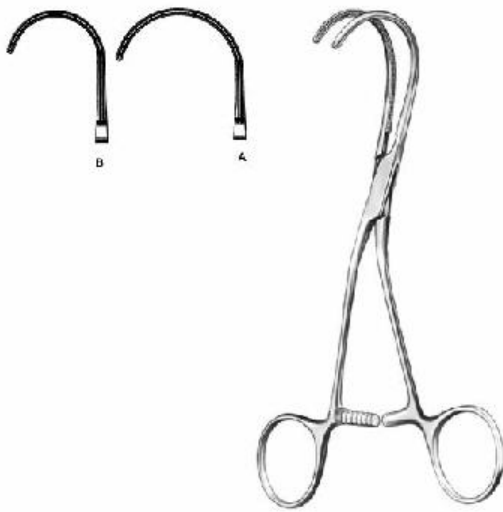

DeBakey

PSI-9-198-16

Multi purpose Vascular Clamp
16.5 cm

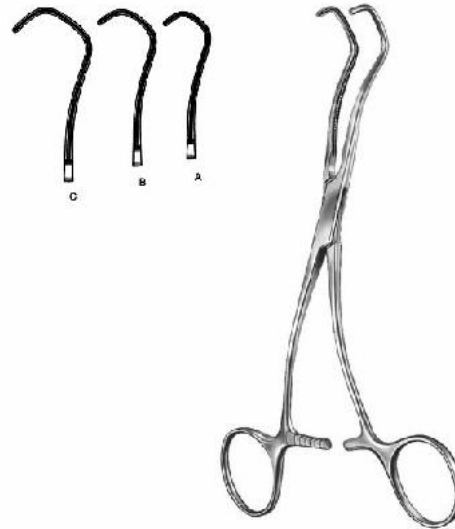

Derra

PSI-9-199-16

Anastomosis Clamp
16 cm Fig. 1, 17.5 cm Fig. 3, 18.5 cm Fig. 3



DeBakey-Beck

PSI-9-200-17

Anastomosis Clamp
17 cm



Cooley

PSI-9-201-16

Vascular Forceps
16 cm

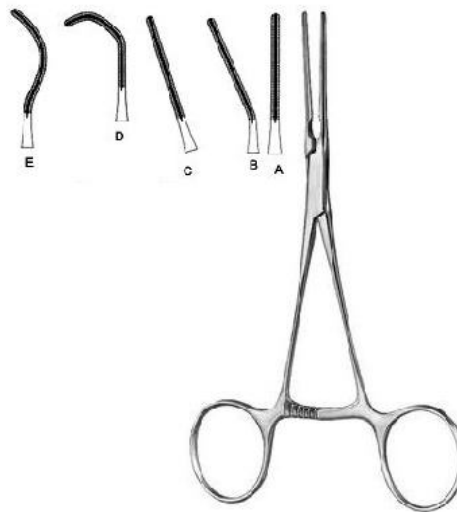

Cooley

PSI-9-202-01

Pediatric Vascular Clamp
14.5 cm



Cooley

PSI-9-203-21

Iliac Clamp
22 cm



Cooley
PSI-9-204-17
Anastomosis Clamp
17 cm

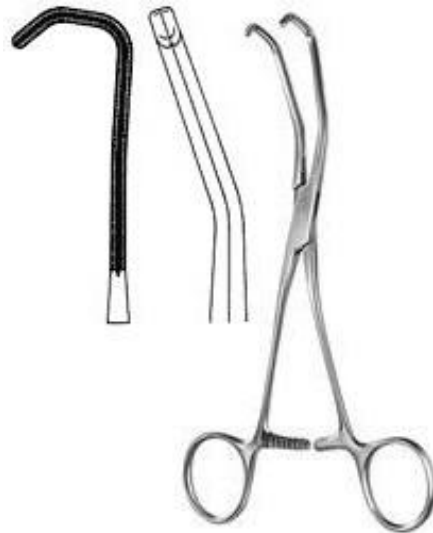

Cooley
PSI-9-205-17
Anastomosis Clamp
20 cm



Cooley
PSI-9-206-16
Anastomosis Clamp
17 cm



Cooley
PSI-9-207-15
Multi purpose Vascular Clamp
16 cm



Cooley
PSI-9-208-17
Multi purpose Vascular Clamp
17 cm



Cooley
PSI-9-209-17
Multi purpose Vascular Clamp
17 cm



Cooley

PSI-9-210-17

Multi purpose Vascular Clamp
17.5 cm

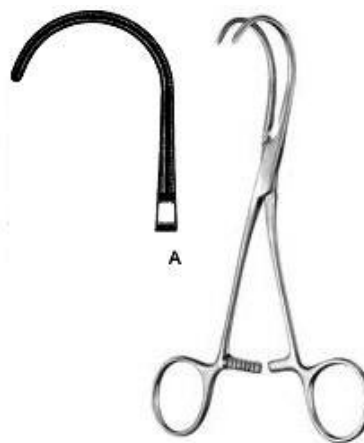

Cooley

PSI-9-211-16

Multi purpose Vascular Clamp
16.5 cm



Cooley-Derra

PSI-9-212-16

Anastomosis Clamp
16.5 cm



Cooley-Beck

PSI-9-213-17

Anastomosis Clamp
17 cm

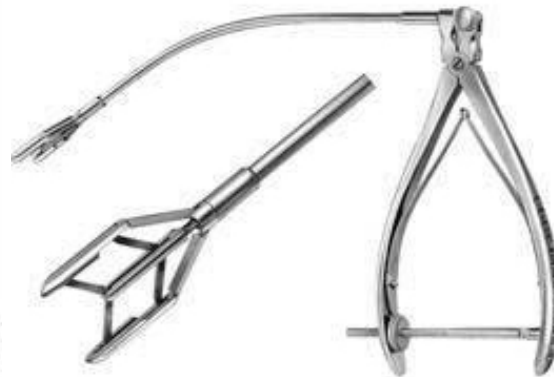

Cooley

PSI-9-214-00

Aortic Dilator



Cooley

PSI-9-215-05

Vascular Dilator
14 cm / 5 ? 11



DeBakey

PSI-9-216-05

Vascular Dilator
19 cm



Martin

PSI-9-217-00

Tunneling Set complete set with three shafts, two handles and 12 tips in storage case.



Hach

PSI-9-218-01

Fasciotomy Knife with plastic handle
30 cm



Intima Spatula

PSI-9-219-18

Intima Spatula
18.5 cm

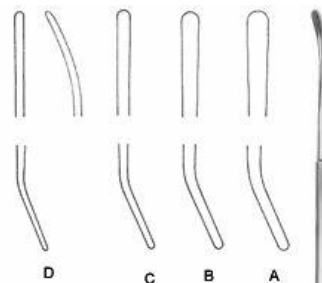

Robb

PSI-9-220-01

Vascular Dissector
24 cm Fig. 1 2,5 mm ? , 24 cm Fig. 2 2,0 mm ?



Crile

PSI-9-221-20

Nerve Hooklet
20 cm

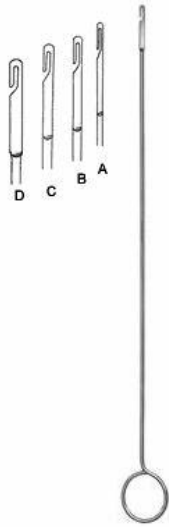

Ligature Catcher

PSI-9-222-15

Ligature Catcher
26 cm 1,5 mm



Subramanian-Miniature

PSI-9-223-15

Aortic Clamp 135 degree
15.5 cm

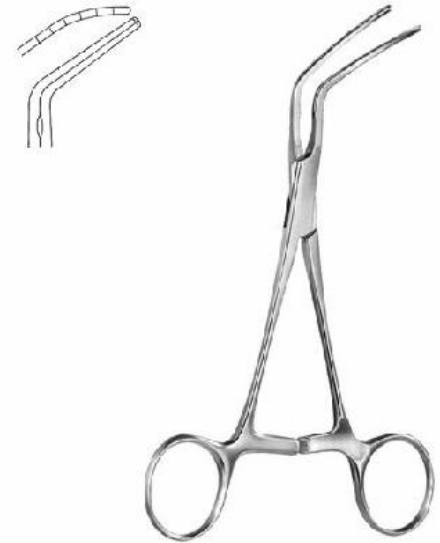

Subramanian

PSI-9-224-16

Aortic Clamp
16 cm

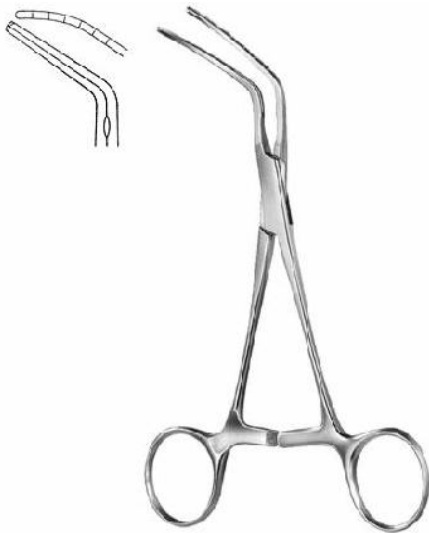

Subramanian

PSI-9-225-16

Aortic Clamp
14 cm Fig. 1 , 14 cm Fig. 2 , 14 cm Fig. 3

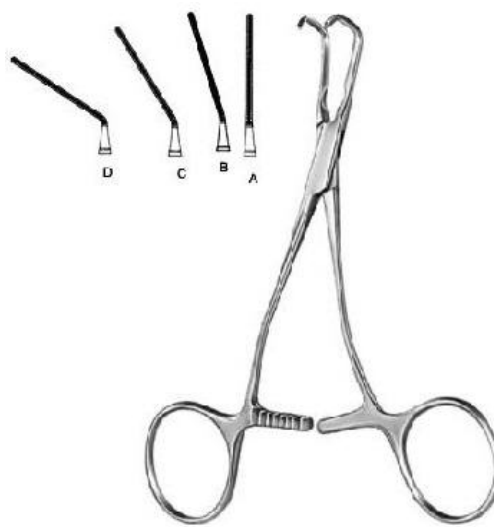

Pediatric Vascular Clamp

PSI-9-226-01

Pediatric Vascular Clamp



Pediatric Vascular Clamp

PSI-9-227-16

Pediatric Vascular Clamp
16.5 cm



Pediatric Vascular Clamp

PSI-9-228-16

Pediatric Vascular Clamp

16 cm

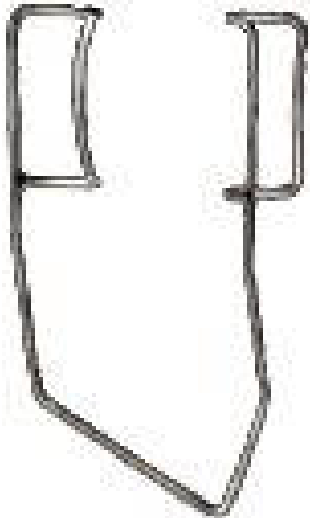

Barraquer (Colibri)

PSI-11-101-03

Barraquer
Size 1

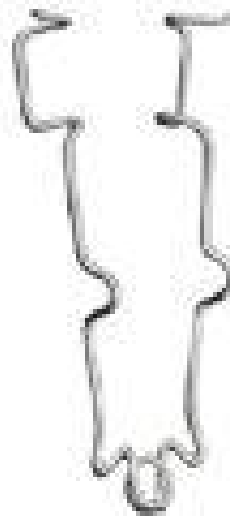

Bowman

PSI-11-102-07

Bowman
Size 1



Critchett

PSI-11-103-06

Critchett
Size 1

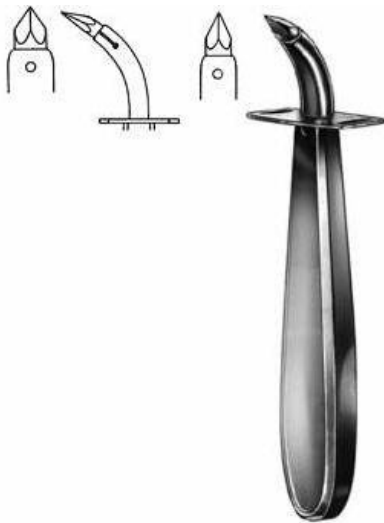

Ueckermann

PSI-16-101-13

Tracheotomy Trocar
11.5 cm



Iterson

PSI-16-102-16

Tracheal Hook
17 cm



Rose

PSI-16-103-13

Tracheal Hook
13.5 cm



Luer

PSI-16-104-11

Tracheal Hook
11 cm

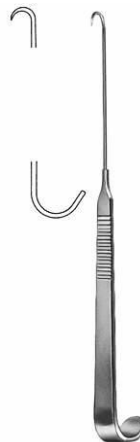

Tracheal Hook

PSI-16-105-15

Tracheal Hook
15 cm



Lukens

PSI-16-106-17

Thymus Retractor
17.5 cm



Jackson
PSI-16-107-17
Tracheal Hook
18 cm



Kocher
PSI-16-108-15
Goitre Enucleator
16.5 cm



Kocher
PSI-16-109-15
Goitre Enucleator
16.5 cm



Hofmeister
PSI-16-110-21
Goitre Enucleator
20.5 cm



Lahey
PSI-16-111-15
Goitre Grasping Forceps
15.5 cm



Luer
PSI-16-112-04
Tracheal Tube



Luer

PSI-6-113-08

Tracheal Tube



Chevalier-Jackson

PSI-16-114-04

Tracheal Tube outer tube closed inner tube
closed silver



Speaking Tube

PSI-16-115-08

Speaking Tube



Moncorps
PSI-17-101-14
Milium Knife
14 cm



Moncorps
PSI-17-102-00
Spare Blade



Vidal
PSI-17-103-14
Lupus Scraper
13 cm



Wolff
PSI-17-105-01
Lupus Curette
14 cm



Kilner
PSI-17-106-15
Skin Hooklet
14.5 cm



Gillies
PSI-17-107-18
Skin Hooklet
18 cm



Kaye

PSI-17-108-03

Face-lift Hook
13 cm

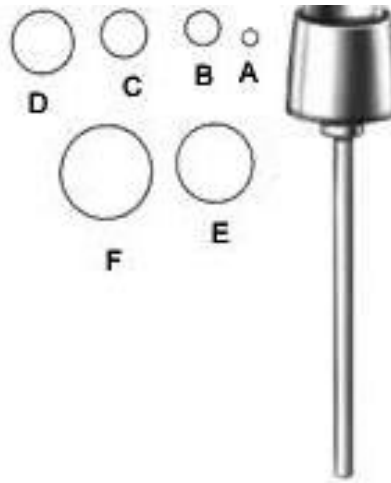

Dermal Punch

PSI-17-109-02

Dermal Punch
5.5 cm



Handle

PSI-17-110-00

Handle
8 cm

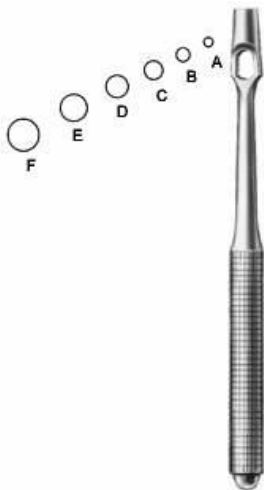

Keyes

PSI-17-111-02

Dermal Punch
11 cm



Unna

PSI-17-113-14

Comedone Extractor
14.5 cm



Saalfeld

PSI-17-114-10

Comedone Extractor
11 cm



Saalfeld

PSI-17-115-14

Saalfeld Comedone Extractor

14.5 cm



Schamberg

PSI-17-116-10

Comedone Extractor

9.5 cm



Katsch

PSI-17-117-14

Comedone Extractor

16 cm



Unna-Vidal

PSI-17-118-11

Comedone Extractor

11.5 cm



D'Assump?

PSI-17-119-15

Face-lift Forceps

18 cm



Gregory

PSI-17-120-14

Face-lift Scissors

14 cm

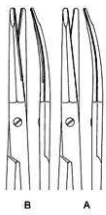

Kaye

PSI-17-121-15

Face-lift Scissors
15 cm, 18 cm



Stella-S

PSI-17-122-18

Face-lift Scissors
18 cm



Gorney

PSI-17-123-18

Face-lift Scissors
18 cm



Freeman-Kaye

PSI-17-124-18

Face-lift Scissors
18 cm



Freeman

PSI-17-125-00

Face-lift Scissors
23 cm



Fox

PSI-17-104-01

Lupus Curette
14 cm

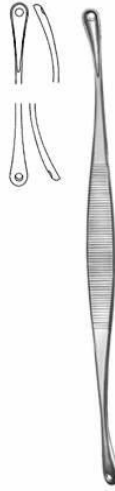

Unna

PSI-17-112-14

Comedone Extractor

14.5 cm



Allis-Baby

PSI-18-101-12

Intestinal and Tissue Grasping Forceps
13 cm

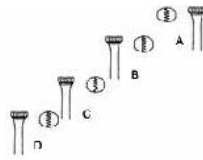

Allis

PSI-18-102-15

Intestinal and Tissue Grasping Forceps
15.5 cm, 19 cm , 25.5 cm



Allis

PSI-18-103-16

Intestinal and Tissue Grasping Forceps
15.5 cm, 20 cm, 24.5 cm, 30 cm



Allis-Adair

PSI-18-104-15

Intestinal and Tissue Grasping Forceps
16 cm



Boys-Allis

PSI-18-105-15

Intestinal and Tissue Grasping Forceps
15.5 cm



Thoms-Allis

PSI-18-106-20

Intestinal and Tissue Grasping Forceps
20.5 cm



Allis

PSI-18-107-20

Intestinal and Tissue Grasping Forceps
20 cm

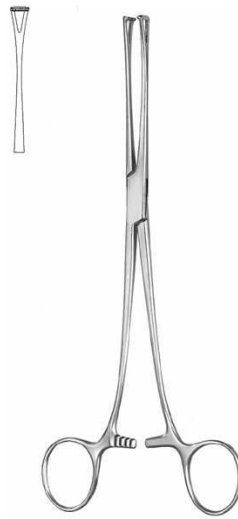

Lockwood

PSI-18-108-20

Intestinal and Tissue Grasping Forceps
20 cm



Williams

PSI-18-109-16

Intestinal and Tissue Grasping Forceps
16.5 cm

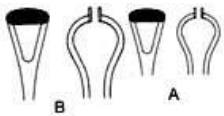

Babcock

PSI-18-110-16

Intestinal and Tissue Grasping Forceps
16.5 cm, 21 cm

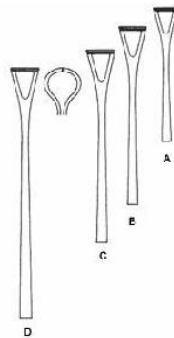

Babcock

PSI-18-111-16

Intestinal and Tissue Grasping Forceps
15.5 cm, 17.5 cm, 21 cm, 24 cm

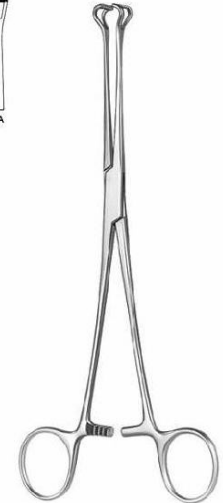
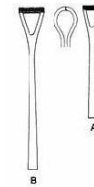

Babcock

PSI-18-112-16

Intestinal and Tissue Grasping Forceps
16.5 cm, 25.5 cm



Duval

PSI-18-113-20

Intestinal and Tissue Grasping Forceps
20.5 cm

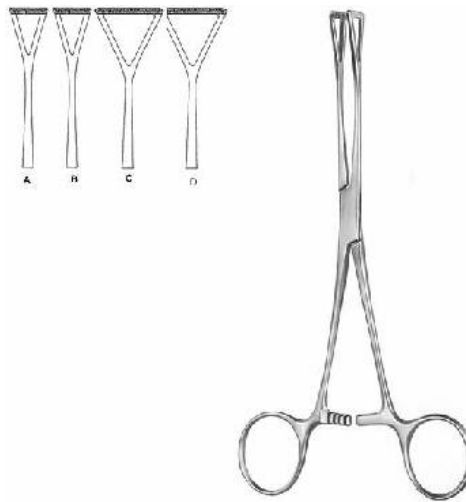

Duval

PSI-18-114-18

Intestinal and Tissue Grasping Forceps
18 cm, 25.5 cm, 23 cm

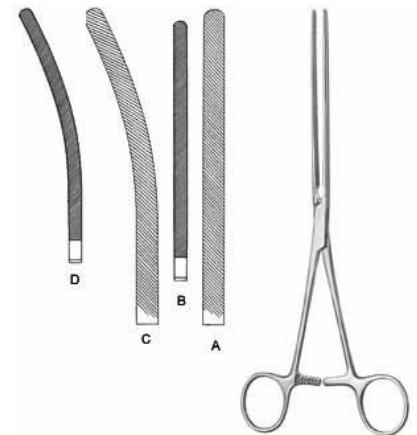

Doyen

PSI-18-115-21

Intestinal Clamp
21.5 cm, 23.5 cm

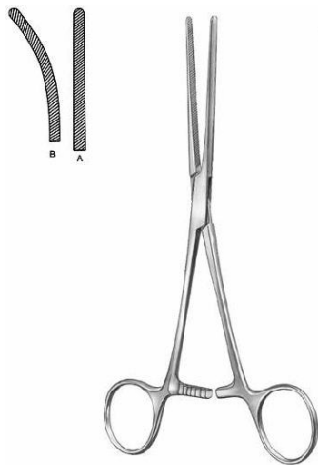

Doyen-Baby

PSI-18-116-18

Intestinal Clamp
18 cm, 17.5 cm

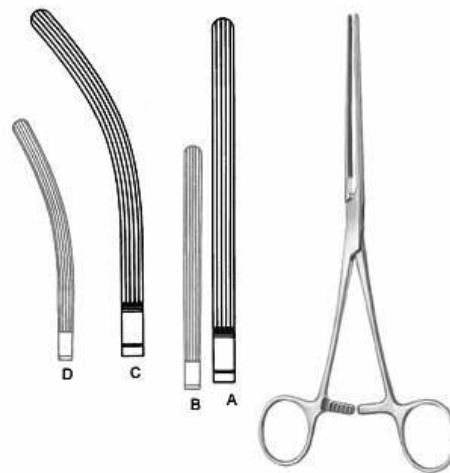

Mayo-Robson

PSI-18-117-21

Intestinal Clamp
21.5 cm, 23.5 cm, 23 cm

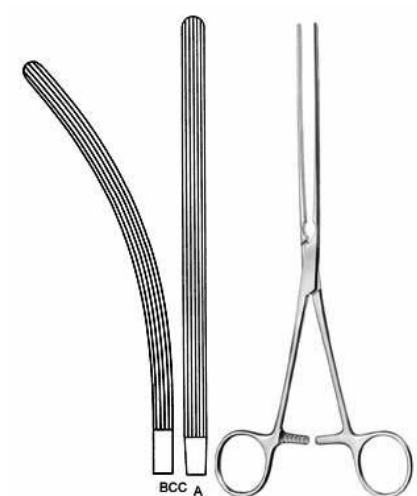

Mayo-Robson

PSI-18-118-25

Intestinal Clamp
25.5 cm, 24.5 cm

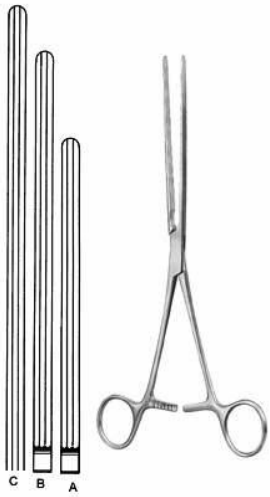

Kocher

PSI-18-119-22

Intestinal Clamp

22.5 cm, 25 cm, 28.5 cm

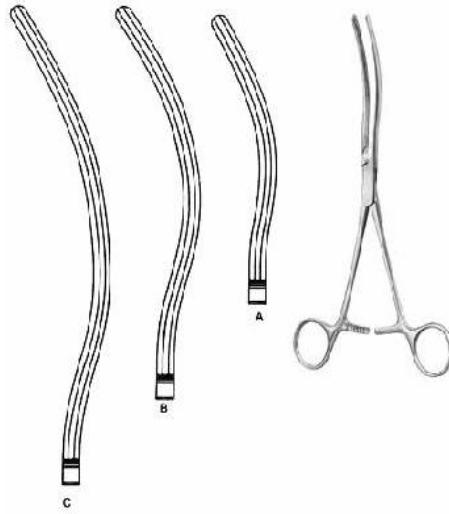

Kocher

PSI-18-120-22

Intestinal Clamp

22 cm, 24.5 cm, 27.5 cm

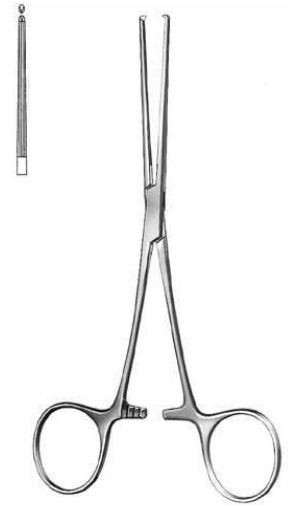

Allen

PSI-18-121-16

Intestinal Clamp

16 cm



Payr-Baby

PSI-18-122-15

Intestinal and Pylorus Clamp

15 cm

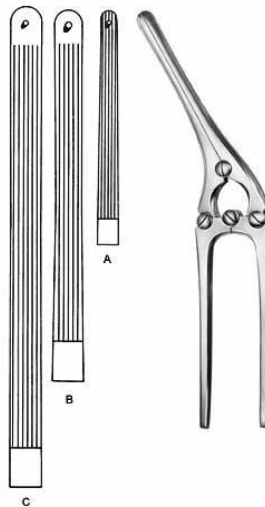

Payr

PSI-18-123-21

Intestinal and Pylorus Clamp

20.5 cm, 29 cm, 34.5 cm



Stone-Watt

PSI-18-124-07

Intestinal Anastomosis Clamp

8.5 cm, 10 cm



Stone-Watt

PSI-18-125-15

Closing Forceps

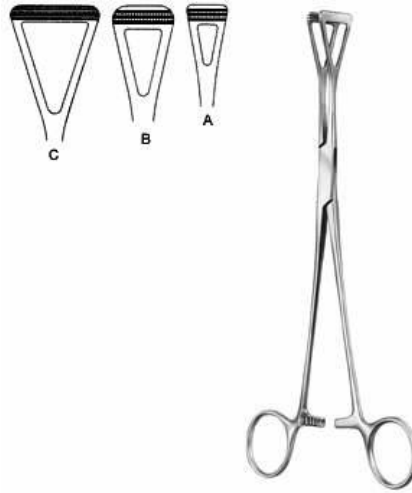

Scheibe

PSI-18-126-18

Organ Grasping Forceps

18 cm

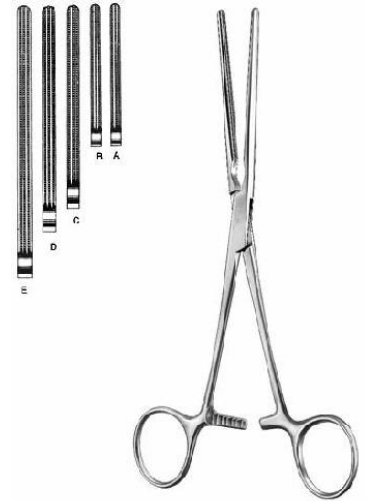

Doyen-Baby

PSI-18-127-13

Intestinal Clamp

14 cm, 17 cm

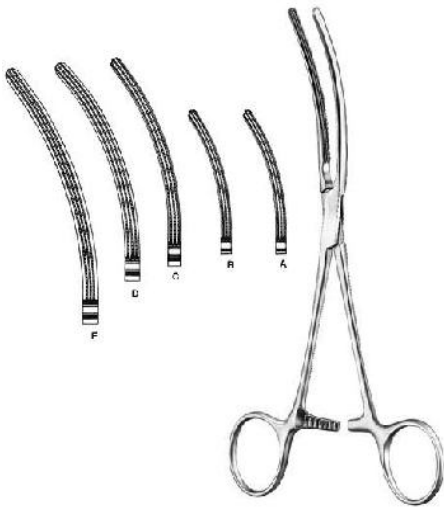

Doyen-Baby

PSI-18-128-13

Intestinal Clamp

13.5 cm, 17 cm



Mayo-Robson

PSI-18-129-25

Intestinal Clamp

26 cm



Mayo-Robson

PSI-18-130-25

Intestinal Clamp

25 cm

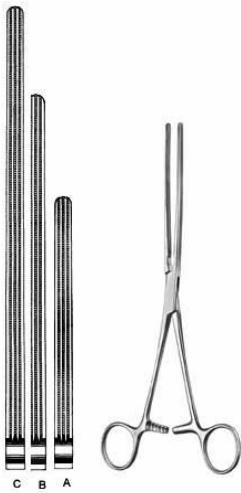

Kocher

PSI-18-131-22

Intestinal Clamp
22.5 cm, 28 cm



Kocher

PSI-18-132-22

Intestinal Clamp
22 cm, 25 cm, 27.5 cm

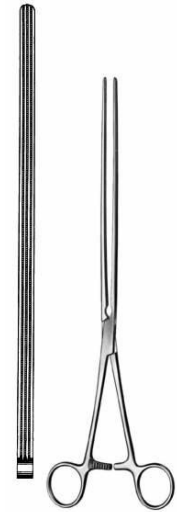

Scudder

PSI-18-133-33

Intestinal Clamp
33.5 cm

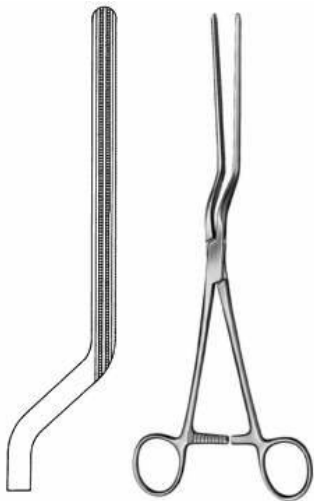

Brunner

PSI-18-134-24

Sigmoid Anastomosis Forceps
27 cm

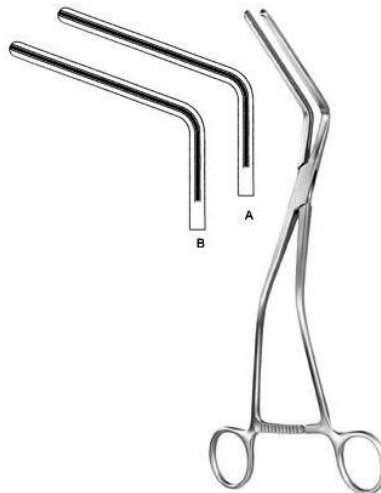

Hayes

PSI-18-135-26

Sigmoid Anastomosis Forceps
27 cm, 28 cm



Veidenheimer

PSI-18-136-23

Sigmoid Anastomosis Forceps
25 cm



Fehland

PSI-18-137-24

Sigmoid Anastomosis Forceps
24 cm

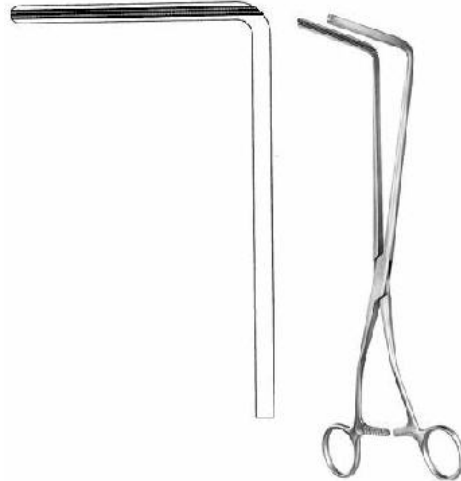

Resano

PSI-18-138-30

Sigmoid Anastomosis Forceps
28 cm



Sims

PSI-18-139-15

Rectal Speculum
15.5 cm



Sims

PSI-18-140-15

Rectal Speculum
15.5 cm



Mathieu

PSI-18-141-19

Rectal Speculum
19 cm



Alan-Parks

PSI-18-142-00

Alan-Parks
14 cm

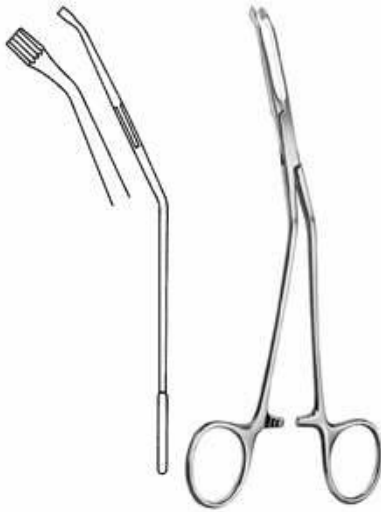

McGinvey

PSI-18-143-19

Hemorrhoidal Grasping Forceps
19 cm



Handle For Biopsy Forceps

PSI-18-144-00

Handle for biopsy forceps

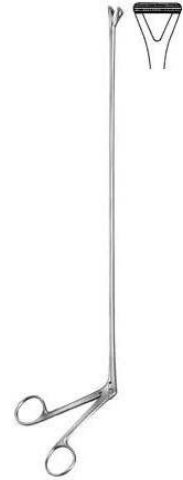

Rectal Biopsy Forceps

PSI-18-145-38

Rectal Biopsy Forceps

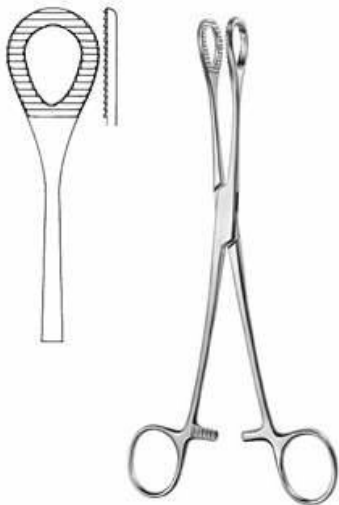

Heywood-Smith

PSI-18-146-21

Polypus Grasping Forceps
21 cm

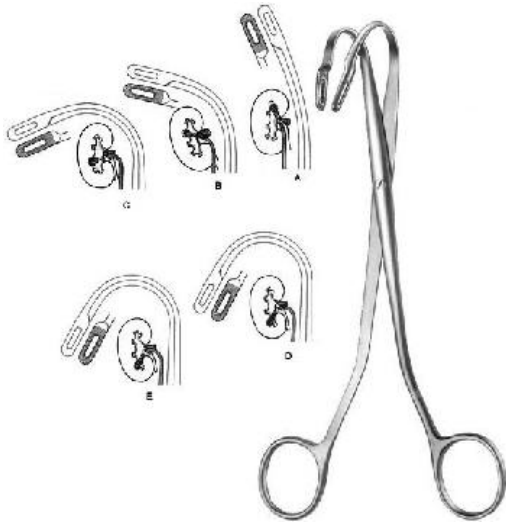

Randall

PSI-19-101-23 A

Kidney Stone Forceps

23 cm Fig. 1 , 21 cm Fig. 2, 21 cm Fig. 3

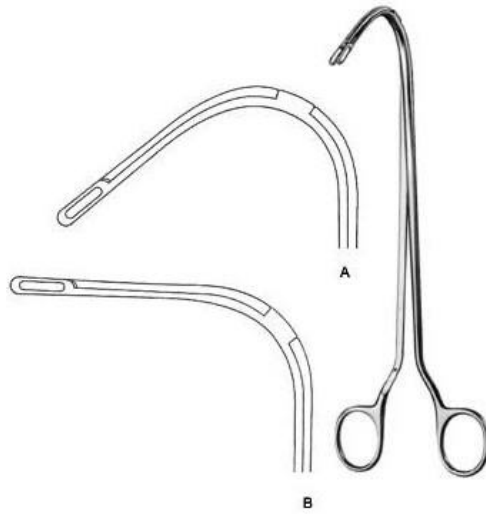

Randall

PSI-19-102-23 A

Kidney Stone Forceps

23 cm , 24.5 cm

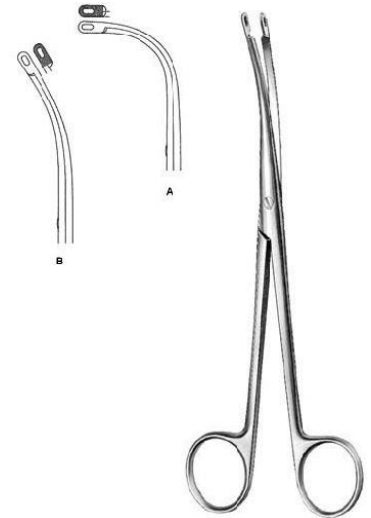

Heiming

PSI-19-103-16 A

Kidney Stone Forceps

16 cm Fig. 1, 17 cm Fig. 2

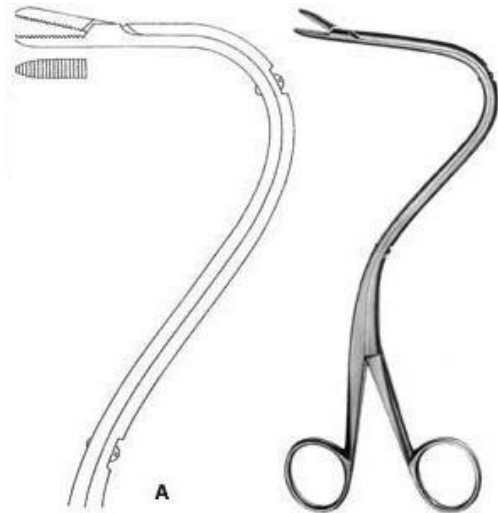

Elsasser

PSI-19-104-01 A

Nephrostomy Forceps

21 cm Fig. 1 , 21 cm Fig. 2



Bakes

PSI-19-105-01 A

Gall Duct Dilator

32 cm

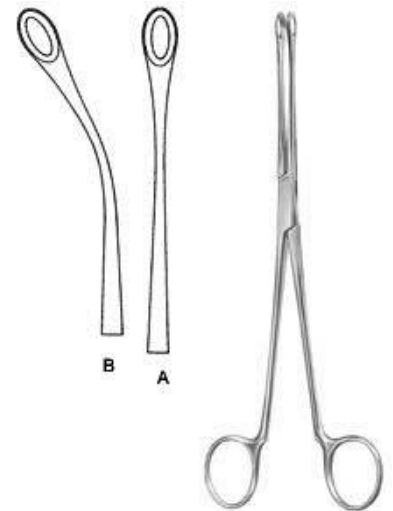

Blake

PSI-19-106-20 A

Gall Stone Forceps

21 cm



Mayo-Blake

PSI-19-107-20

Gall Stone Forceps
21 cm



Mayo-Blake

PSI-19-108-20

Gall Stone Forceps
21 cm



Mixer

PSI-19-109-22

Gall Stone Forceps
21.5 cm



Desjardins

PSI-19-110-23 A

Gall Stone Forceps
23 cm

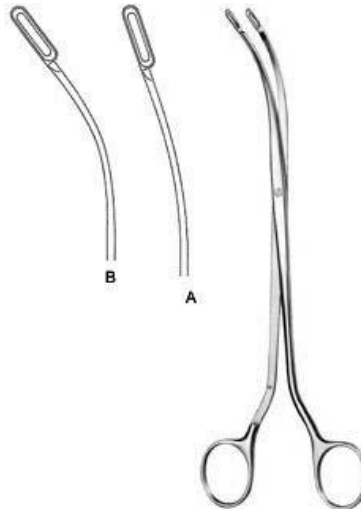

Desjardins

PSI-19-111-24 A

Gall Stone Forceps



Luer-Korte

PSI-19-112-01 A

Gall Stone Scoop
32 cm Fig. 0, 32 cm Fig. 00, 32 cm Fig. 000, 32 cm Fig. 1, 32 cm Fig. 2, 32 cm Fig. 3, 32 cm Fig. 4

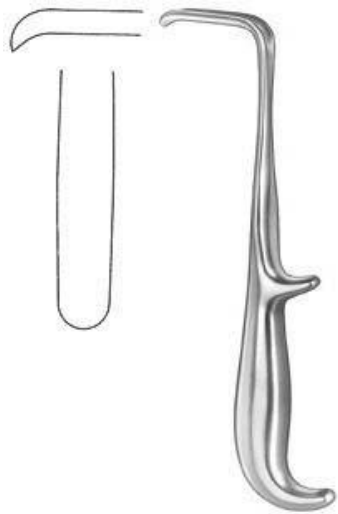

Young

PSI-19-113-21

Prostatic Retractor
21.5 cm



Young

PSI-19-114-22

Prostatic Retractor
20.5 cm



Young

PSI-19-115-21

Prostatic Retractor
22 cm

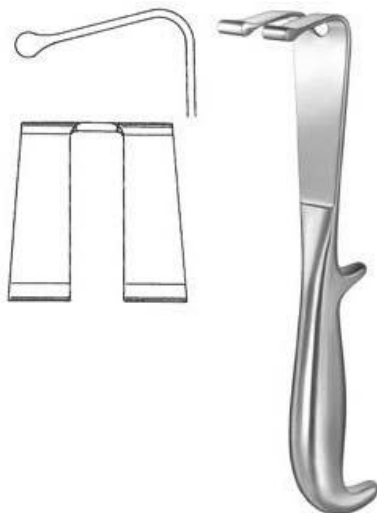

Young

PSI-19-116-22

Prostatic Retractor
21.5 cm



Millin

PSI-19-117-24

Capsule Forceps
24.5 cm

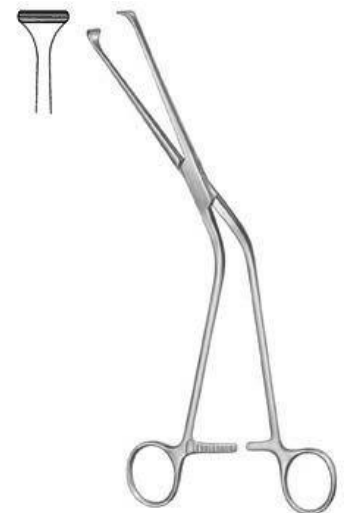

Millin

PSI-19-118-24

Capsule Forceps
22 cm

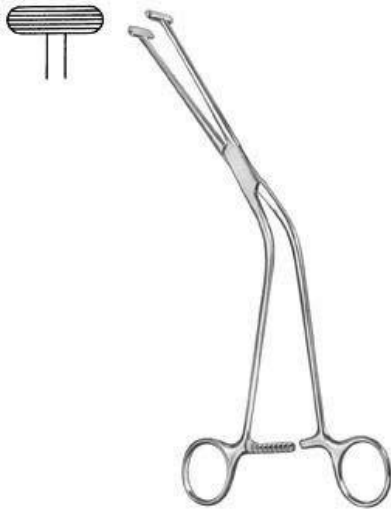

Millin
PSI-19-119-23
Capsule Forceps
24.5 cm

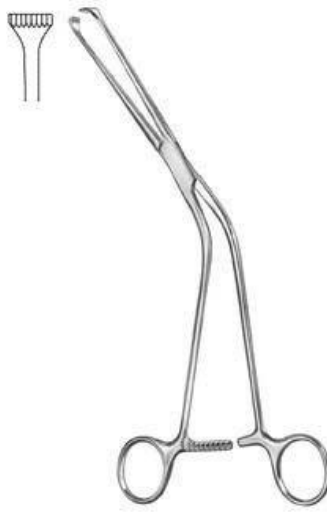

Millin
PSI-19-120-23
Capsule Forceps
22 cm

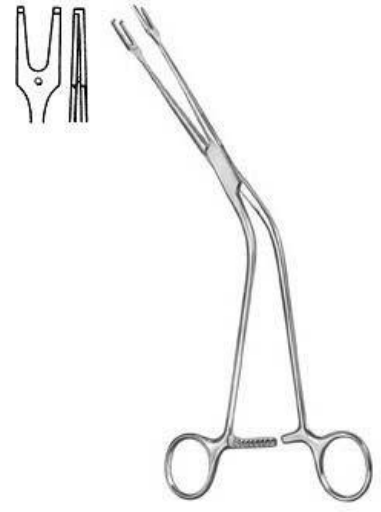

Millin
PSI-19-121-24
Ligature Carrying Forceps
24.5 cm



Millin
PSI-19-122-00
Bladder Neck Spreader
29



Thomson-Walker
PSI-19-123-00
Bladder Retractor



Judd-Masson
PSI-19-124-00
Bladder Retractor



Millin

PSI-19-125-00 A

Bladder Retractor



Legueu

PSI-19-126-27

Bladder Spatula

24 cm , 35 mm



Van Buren

PSI-19-127-00 A

Urethral Sound

27.5 cm

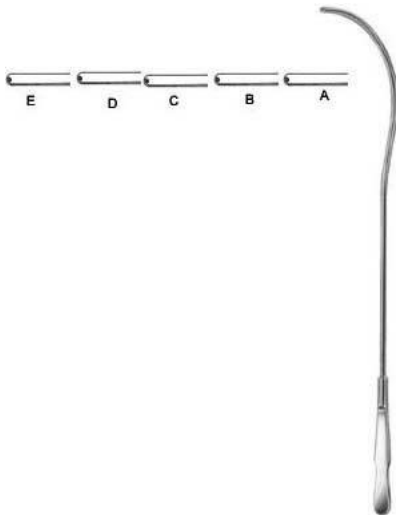

Guyon

PSI-19-128-10 A

Urethral Sound

26 cm



Cusco

PSI-20-101

Vaginal Speculum
75 x 32 mm, 85 x 35 mm



Cusco

PSI-20-102-01

Vaginal Speculum
75 x 18 mm



Cusco

PSI-20-103-01

Vaginal Speculum
80 x 22 mm, 100 x 25 mm, 105 x 27 mm



Cusco

PSI-20-104-01

Vaginal Speculum
75 x 34 mm, 85 x 37 mm



Collin

PSI-20-105-01

Vaginal Speculum
85 x 30 mm, 100 x 35 mm

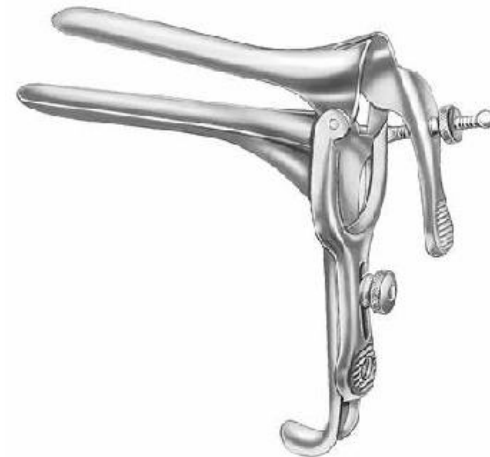

Pederson

PSI-20-106-01

Vaginal Speculum
75 x 13 mm, 100 x 22 mm



Grave

PSI-20-107-01

Vaginal Speculum

75 x 20 mm, 95 x 35 mm



Semm

PSI-20-108-01

Vaginal Speculum

100 x 20 mm, 105 x 27 mm



Sims

PSI-20-109-01

Vaginal Speculum

65 x 25 mm, 70 x 30 mm



Kristeller

PSI-20-110-01

Vaginal Speculum

70 x 27 mm



Kristeller

PSI-20-111-01

Vaginal Retractor

75 x 23 mm



Kristeller

PSI-20-112-01

Vaginal Speculum

Size 1



Kristeller

PSI-20-113-01

Vaginal Speculum
105 x 18 mm



Kristeller

PSI-20-114-01

Vaginal Retractor
110 x 14 mm



Kristeller

PSI-20-115-01

Vaginal Speculum
Size 1

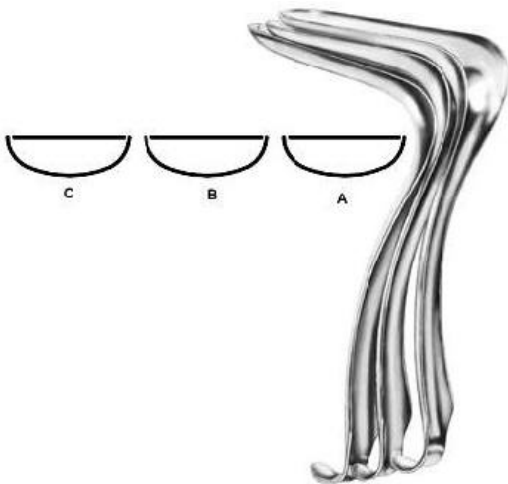

Kristeller

PSI-20-116-01

Vaginal Speculum
105 x 26 mm

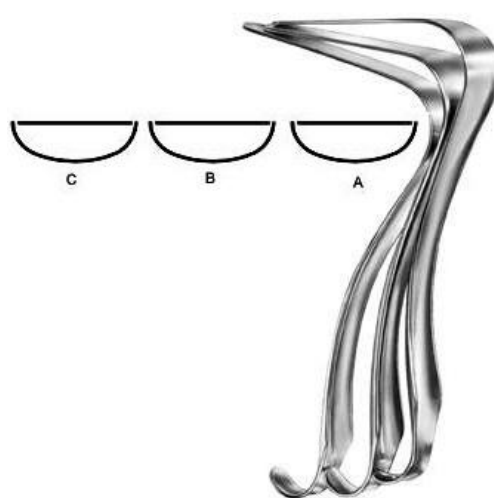

Kristeller

PSI-20-117-01

Vaginal Retractor
115 x 22 mm, 115 x 23 mm



Kristeller

PSI-20-118-01

Vaginal Speculum
Size 1

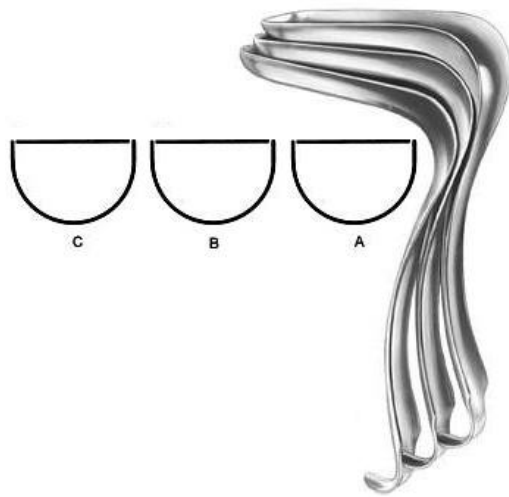

Kristeller

PSI-20-119-01

Vaginal Speculum
110 x 27 mm

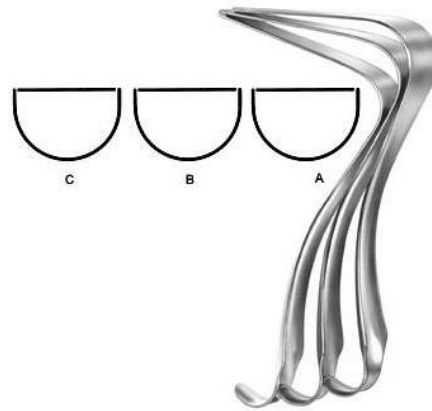

Kristeller

PSI-20-120-01

Vaginal Retractor
115 x 23 mm

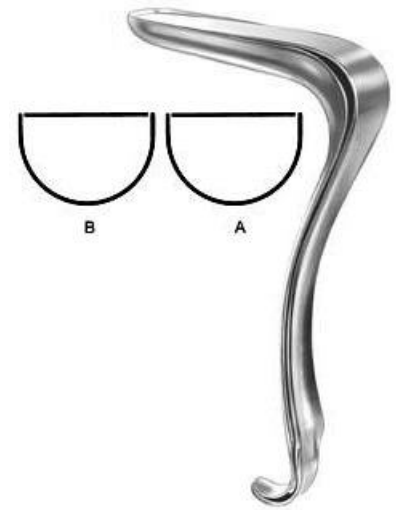

Kallmorgen

PSI-20-121-01

Vaginal Speculum



Kallmorgen

PSI-20-122-01

Vaginal Retractor
70 x 40 mm Fig. 1, 90 x 40 mm Fig. 2



Kallmorgen

PSI-20-123-01

Vaginal Speculum
70 x 33 mm, 90 x 33 mm

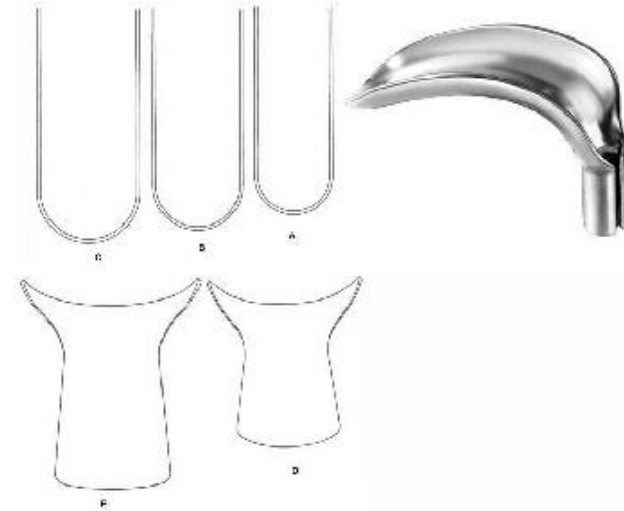

Scherbak

PSI-20-125-00

Vaginal Speculum
Size 1



Auvard

PSI-20-126-22

Vaginal Speculum
80 x 43 mm



Weissbarth

PSI-20-127-24

Vaginal Speculum
21 cm 80 x 42 mm



Breisky

PSI-20-128-20

Vaginal Speculum
29 cm 100 x 20 mm, 29 cm 100 x 25 mm



Kogan

PSI-20-129-24

Endocervical Speculum
25 cm 70 x 30 mm



Kogan

PSI-20-130-24

Endocervical Speculum
24.5 cm



Hegar

PSI-20-131-24

Uterine Dilator
18.5 cm 1,0



Hegar

PSI-20-132-02

Uterine Dilator
20 cm 1,0



Hank

PSI-20-133-10

Uterine Dilator
26.5 cm Fig. 9/10



Sims

PSI-20-134-32

Uterine Sound
33 cm



Valleix

PSI-20-135-25

Uterine Sound
29.5 cm



Braun

PSI-20-136-26

Uterine Depressor
27.5 cm



Schroder

PSI-20-137-25

Uterine Tenaculum Forceps
25.5 cm



Braun

PSI-20-138-25

Uterine Tenaculum Forceps
26 cm



Duplay

PSI-20-139-28

Uterine Tenaculum Forceps
25.5 cm



Beacham

PSI-20-140-26

Amniotome
26 cm



Skene

PSI-20-141-24

Uterine Tenaculum Forceps
24 cm

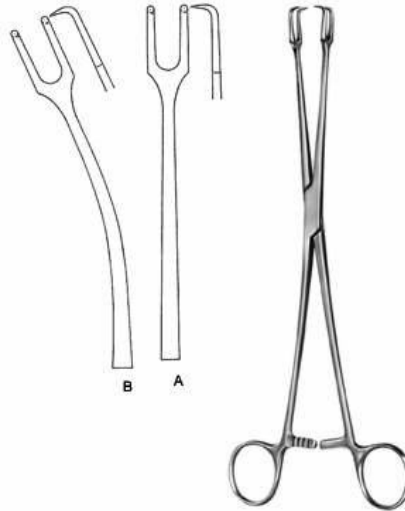

Schroder

PSI-20-142-24

Uterine Tenaculum Forceps
25 cm



Teale

PSI-20-143-23

Uterine Tenaculum Forceps
23.5 cm

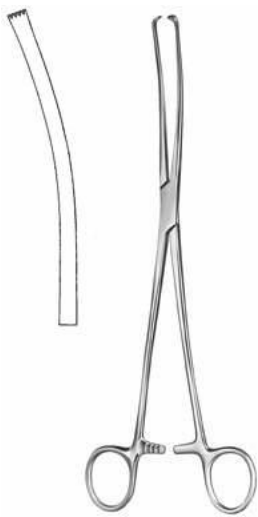

Iowa

PSI-20-144-26

Uterine Tenaculum Forceps
26 cm



Museux

PSI-20-145-24

Uterine Tenaculum Forceps
24 cm



Jacobs

PSI-20-146-21

Uterine Tenaculum Forceps
21 cm



Uterine Tenaculum Forcep

PSI-20-147-26

Uterine Tenaculum Forcep
26.5 cm



Braun

PSI-20-148-16

Uterine Tenaculum Forceps
16 cm

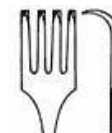

Czerny

PSI-20-149-21

Uterine Tenaculum Forceps
21 cm



Kelly

PSI-20-150-32

Uterine Polypus Forceps
32 cm



Noto

PSI-20-151-27

Uterine Polypus Forceps
27 cm

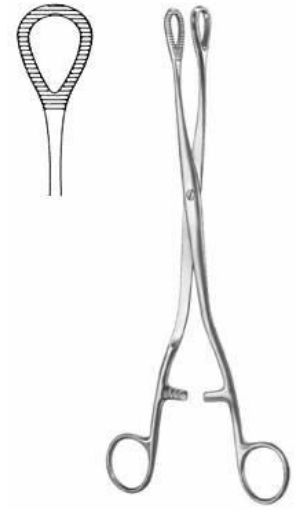

Heywood-Smith

PSI-20-152-25

Uterine Polypus Forceps
25 cm

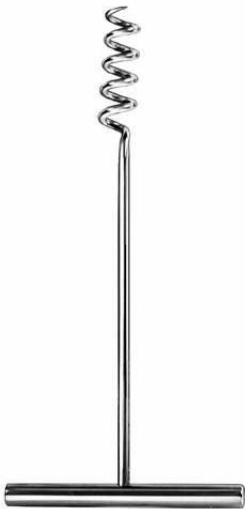

Doyen

PSI-20-153-17

Myoma Screw
17 cm



Doyen

PSI-20-154-17

Myoma Screw
14.5 cm



Segond

PSI-20-155-27

Myoma Knife
28 cm

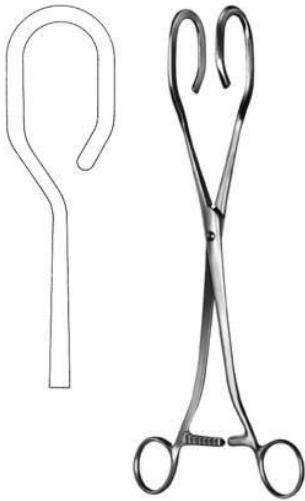

Dartigues

PSI-20-156-27

Uterine Seizing Forceps

28 cm



Somer

PSI-20-157-27

Uterine Seizing Forceps

22.5 cm



Collin

PSI-20-158-25

Uterine Seizing Forceps jaw 40 mm wide

26 cm



Ayre

PSI-20-159-23

Conization Knife cutting edge 3,6 mm wide

23.5 cm



Emmett

PSI-20-160-03

Fistula Hook

22 cm Fig.3



Simon

PSI-20-161-22

Fistula Hook

21.5 cm



Simon

PSI-20-162-22

Fistula Hook
21.5 cm



Novak

PSI-20-163-23

Suction Curette 4 mm ?
24.5 cm



Kevorkian

PSI-20-164-23

Uterine Biopsy Curette 6,0 mm ?
30 cm



Munchen

PSI-20-165-27

Uterine Biopsy Curette 4,8 mm ?
27 cm



Gellhorn

PSI-20-166-23

Uterine Biopsy Forceps jaw 8,6 mm wide
24 cm



Faure

PSI-20-167-21

Faure Uterine Biopsy Forceps
21 cm



Schubert

PSI-20-168-21

Uterine Biopsy Forceps jaw 4,8 mm wide
21.5 cm, 28 cm

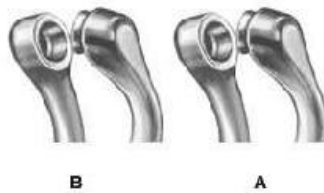

Thoms-Gaylor

PSI-20-169-22

Uterine Biopsy Forceps jaw 5,6 mm ?
21 cm, 23.5 cm

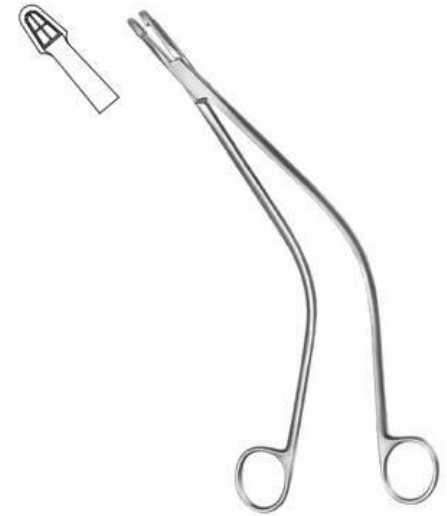

Schubert

PSI-20-170-26

Schubert Uterine Biopsy Forceps
25.5 cm

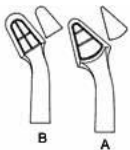

Van Doren

PSI-20-171-24

Uterine Biopsy Forceps jaw 4,9 mm wide
27 cm, 25.5 cm



Alexander

PSI-20-172-28

Uterine Biopsy Forceps jaw 5,1 mm wide
28 cm



Kevorkian

PSI-20-173-32

Uterine Biopsy Forceps
25 cm

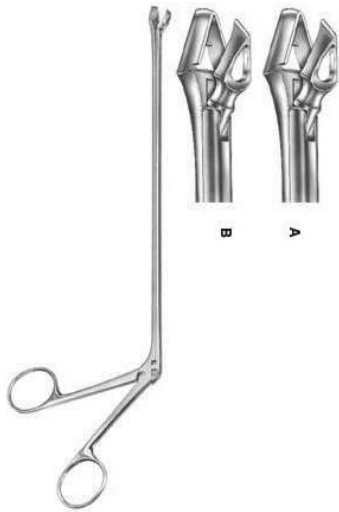

Schumacher

PSI-20-174-01

Uterine Biopsy Forceps jaw 4,6 / 5,4 mm wide
24 cm



Schumacher

PSI-20-175-00

Uterine Biopsy Forceps
25 cm



IUP Grasping Forceps 3 Mm ?

PSI-20-176-22

IUP Grasping Forceps 3 mm ?
22 cm

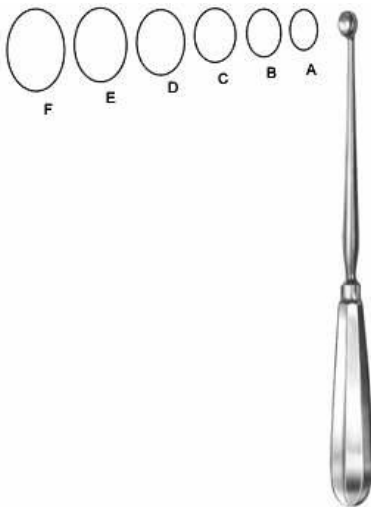

Simon

PSI-20-177-01

Uterine Scoop

24.5 cm 9,8 x 8,6 mm, 24.5 cm 11,6 x 8,3 mm



Simon

PSI-20-178-01

Uterine Scoop

30 cm 9,8 x 8,6 mm, 30 cm 11,6 x 8,3 mm



Recamier

PSI-20-179-05

Uterine Curette

31 cm Fig. 00 5 mm, 31 cm Fig. 0 6 mm



Recamier

PSI-20-180-05

Uterine Curette

31 cm Fig. 00 5 mm, 31 cm Fig. 0 6 mm



Sims

PSI-20-181-05

Uterine Curette

31 cm Fig. 00 5 mm, 31 cm Fig. 0 6 mm

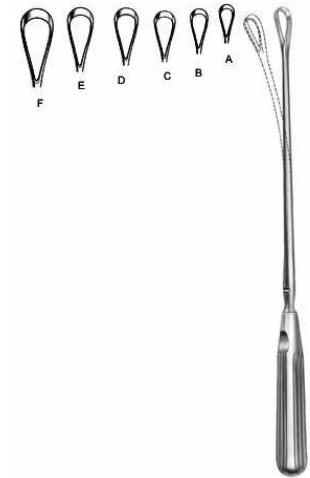

Sims

PSI-20-182-05

Uterine Curette

31 cm Fig. 00 5 mm, 31 cm Fig. 0 6 mm

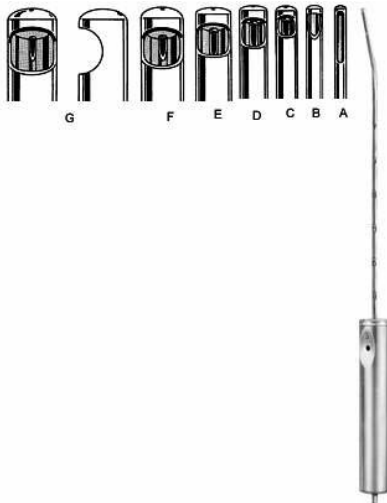

Suction Curette

PSI-0-183-03

Suction Curette

29 cm 3,0 mm ?, 29 cm 4,5 mm ?, 29 cm 6,0 mm ?



Martin

PSI-21-101-34

Pelvimeter cm, inch scale
34 cm



Nagele

PSI-5-102-36

Obstetrical Forceps
35 cm, 40.5 cm



Simpson

PSI-5-103-30

Obstetrical Forceps
31 cm



Wrigley

PSI-5-104-28

Obstetrical Forceps
28 cm



Simpson

PSI-21-105-36

Obstetrical Forceps
36.5 cm



Kielland

PSI-21-106-41

Obstetrical Forceps
42 cm

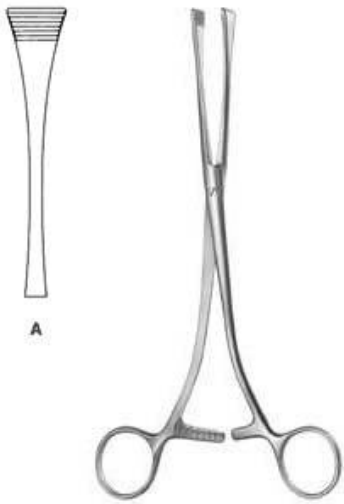

Green-Armytage

PSI-21-107-21

Uterine Clamp
21 cm



Sellheim

PSI-21-108-28

Obstetrical Lever
32 cm

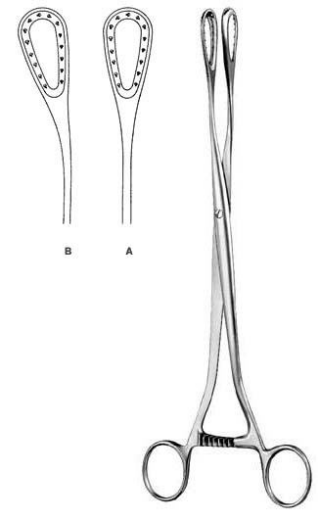

Sanger

PSI-21-109-27

Placenta and Ovum Forceps
27.5 cm, 27 cm

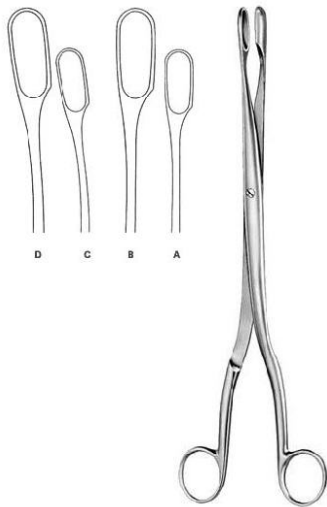

Winter

PSI-21-110-01

Placenta and Ovum Forceps
28 cm Fig. 1, 28 cm Fig. 2

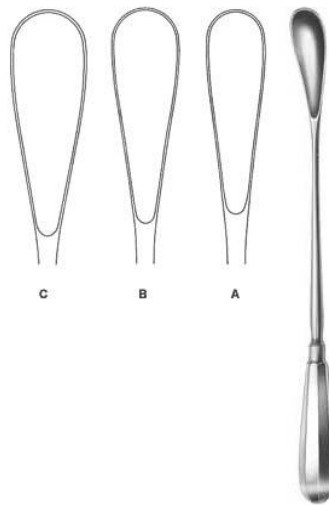

Cuzzi

PSI-21-111-01

Placenta Scoop
30 cm 14,5 mm, 30 cm 18 mm



Pestalozza

PSI-21-112-30

Placenta Scoop
30 cm

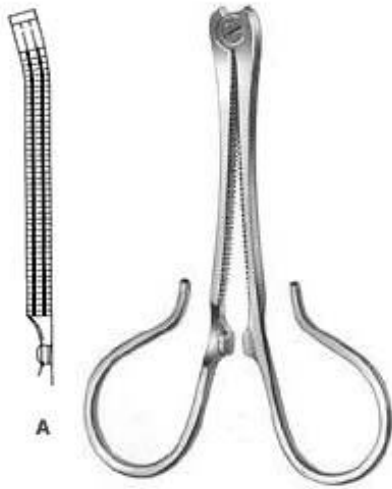

Kane

PSI-21-113-08

Umbilical Cord Clamp
8.5 cm



Collin

PSI-21-114-09

Umbilical Cord Clamp
8.5 cm



Irrigator

PSI-23-101-10

Sterilization
Size 1



Round Bowl

PSI-23-102-16

Sterilization
220 mm x 70 mm, 400 mm x 150 mm



Round Bowl

PSI-23-103-33

Sterilization
? x h 6,00 l



Flat Dish

PSI-23-104-11

Sterilization
? x h 0,20 l

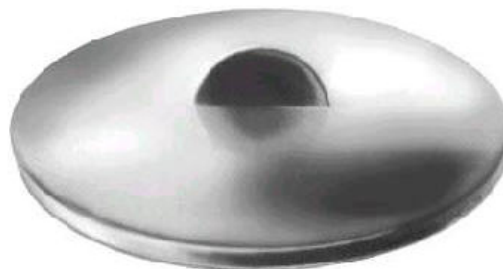

Lid Only

PSI-23-105-11

Sterilization
Size 1



Stainless Steel

PSI-23-106-04

Sterilization
? x h 0,30 l



Round Dish

PSI-23-107-11

Sterilization

? x h 0,30 l, ? 128 x 38 mm 0,40 l



Flat Dish

PSI-23-108-11

Sterilization

? x h 0,15 l



Measurer

PSI-23-109-01

Graduated inside

100cc = 0,1 l



Measurer

PSI-23-110-02

Graduated Inside

0,25 l, 0,50 l



Petri Dish

PSI-23-111-10

with Lid ? x h



Petri Dish

PSI-23-112-09

without lid ? x h

Size 1



Lid For Petri Dishes

PSI-23-113-10

Sterilization
Size 1



Universal Tray

PSI-23-114-23

Sterilization
l x b x h



Instrument Tray

PSI-23-115-21

Sterilization
l x b x h



Universal Tray

PSI-23-116-23

Sterilization
l x b x h



Round Bowl

PSI-23-117-22

Sterilization
? x h



Metal Jar

PSI-23-118-30

Sterilization
? 30mm x 90 mm, ? 50mm x 100 mm



Instrument Box

PSI-23-119-16

lid with knob
l x b x h



Instrument Box

PSI-23-120-16

lid with knob
l x b x h



Instrument Box

PSI-23-121-20

Sterilization
l x b x h



Round Metal Box

PSI-23-122-06

Sterilization
? 75 mm x 75 mm, ? 100 mm x 60 mm



Medicine Cup Graduated Inside

PSI-23-123-25

Sterilization
25 cm



Medicine Cup Graduated Inside

PSI-23-124-50

Sterilization
50 cm



Tablet Tray

PSI-23-125-75

Sterilization
? 75 mm x 12 mm



Metal Cup

PSI-23-126-90

Sterilization
? 90 mm x 90 mm



Denture Cup

PSI-23-127-75

Sterilization
? 75 mm x 50 mm



Insert For Cup

PSI-23-128-75

Sterilization
? 73 mm x 75 mm



Kidney Dish

PSI-23-129-17

Kidney Dish
l x b x h



Placenta Pan

PSI-23-130-36

Sterilization
Size 1



Waste Cotton Collector

PSI-23-131-01

Sterilization
? 50 mm x 75 mm



Spirit Lamp

PSI-23-132-07

Sterilization
120 cm



Charri?Re

PSI-7-102-35

Amputation Saw
35 cm



Langenbeck

PSI-7-103-23

Amputation Saw
24.5 cm



Charriere

PSI-7-104-27

Amputation Saw
26.5 cm



Reamer

PSI-7-105-14

Reamer
13.5 cm



Perthes

PSI-7-106-18

Reamer
18 cm

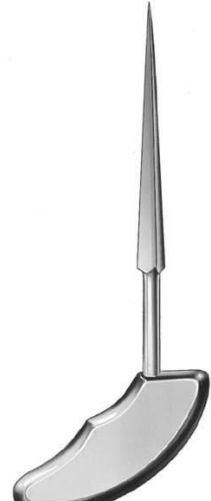

Perthes

PSI-7-107-21

Reamer
21.5 cm



Reamer

PSI-7-108-14

Reamer
14 cm



Flat Trephine

PSI-7-111-18

Flat Trephine

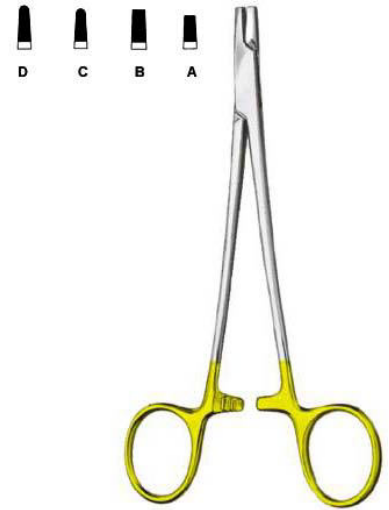

Wire Twisting Forceps

PSI-7-112-01

Wire Twisting Forceps
15.5 cm, 18 cm, 20 cm



Wire Twisting Forceps

PSI-7-113-15

Wire Twisting Forceps
15.5 cm



Flat Nose Plier

PSI-7-114-17

Flat Nose Plier
18.5 cm



Wire Twisting Forceps

PSI-7-115-18

Wire Twisting Forceps
19 cm



Combi-Flat Nose Plier

PSI-7-116-15

Combi-Flat Nose Plier
15 cm

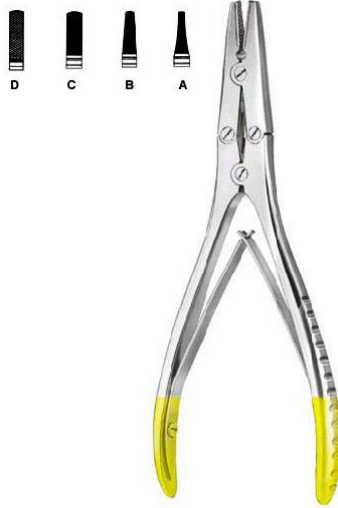

Flat Nose Plier

PSI-7-117-01

Flat Nose Plier
18 cm

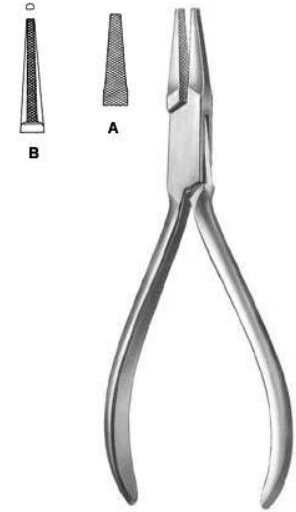

Flat Nose Plier

PSI-7-118-14

Flat Nose Plier
13.5 cm



Hackstock

PSI-7-119-16

Flat Nose Plier
16 cm



Flat Nose Plier

PSI-7-120-01

Flat Nose Plier
17.5 cm



Wire Cutting Pliers

PSI-7-121-18

Wire Cutting Pliers
18.5 cm



Wire Cutting Pliers

PSI-7-122-15

Wire Cutting Pliers
15 cm



Wire Cutting Pliers

PSI-7-123-18

Wire Cutting Pliers
17.5 cm

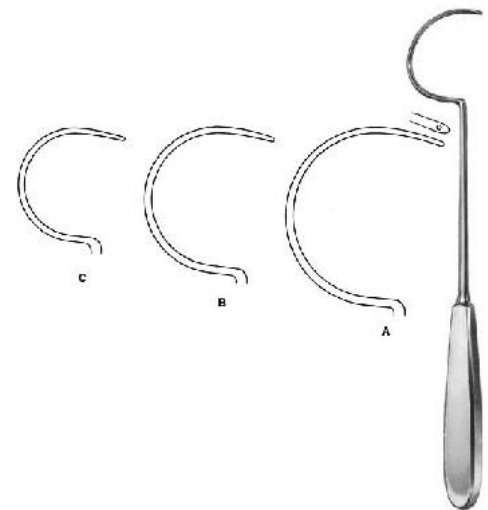

Demel

PSI-7-124-18

Wire Guide
28 cm Fig. 3 , 29 cm Fig. 2 , 31 cm Fig. 1

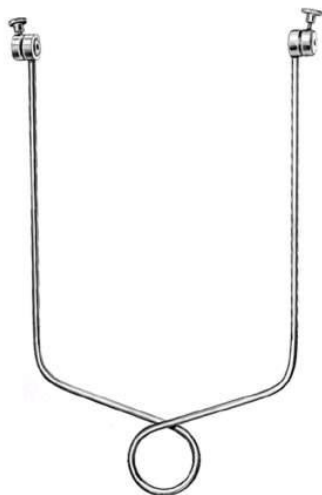

Bohler

PSI-7-125-15

Extension Bow



Kirschner

PSI-7-126-01

Extension Bow
18.5 cm , 26.5 cm



Traction Hook For Extention Bows

PSI-7-127-06

Traction Hook for Extention Bows



Kirschner
PSI-7-128-06
Wire Drill
6 cm, 12 cm



Kirschner
PSI-7-129-06
Wire Drill
14 cm, 16 cm



Kirschner
PSI-7-130-10
Wire Drill
31 cm



Kirschner
PSI-7-131-10
Wire Drill
12 cm, 16 cm, 18 cm



Kirschner
PSI-7-132-10
Wire Drill
31 cm



Buckley
PSI-7-133-02
Chisel
16 cm



Buckley

PSI-7-134-02

Gouge
16 cm



Stout

PSI-7-135-03

Bone Chisel
21 cm



Bone Chisel

PSI-7-112-01

Bone Chisel
18 cm



Bone Chisel

PSI-7-137-04

Bone Chisel
18 cm



Bone Chisel

PSI-138-04

Bone Chisel
17 cm



Bone Chisel

PSI-7-139-04

Bone Chisel
17 cm

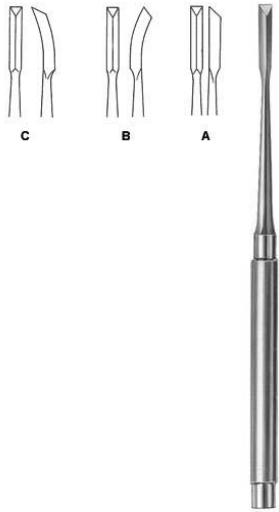

Gardner

PSI-7-112-01

Bone Chisel
17 cm 4mm



Snyder-O.S.U.

PSI-7-141-03

Bone Chisel
16.5 cm 3mm , 16.5 cm 5.5mm



O.S.U.

PSI-7-142-01

one Chisel
17 cm 7mm



O.S.U.

PSI-7-143-01

One Chisel
17 cm 9mm



Osteotome

PSI-7-144-08

Osteotome
13.5 cm 8mm , 13.5 cm 10mm , 13.5 cm 12mm ,
13.5 cm 14mm , 13.5 cm 16mm

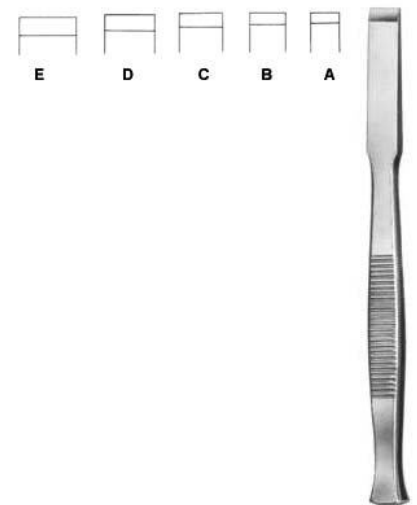

Chisel

PSI-7-145-08

Chisel
13.5 cm 8mm , 13.5 cm 10mm , 13.5 cm 12mm ,
13.5 cm 14mm , 13.5 cm 16mm



Gouge

PSI-7-146-08

Gouge

13.5 cm 8mm , 13.5 cm 10mm , 13.5 cm 12mm ,
13.5 cm 14mm , 13.5 cm 16mm



Partsch

PSI-7-147-02

Chisel

13.5 cm 2mm , 13.5 cm 3mm , 13.5 cm 4mm , 13.5
cm 5mm , 13.5 cm 6mm , 17 cm 2mm , 17 cm
3mm , 17 cm 4mm , 17 cm 5mm , 17 cm 6mm



Partsch

PSI-7-148-02

Gouge

13.5 cm 2mm , 13.5 cm 3mm , 17 cm 2mm , 17 cm
3mm

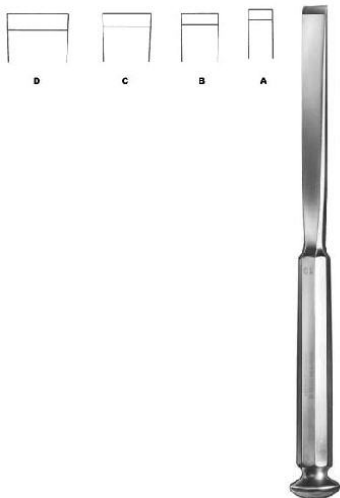

Stille

PSI--7-149

Chisel

20 cm 10mm , 20 cm 15mm , 20 cm 20mm , 20
cm 25mm



Stille

PSI--7-150

O

20 cm 10mm , 20 cm 15mm , 20 cm 20mm , 20
cm 25mm



Stille

PSI-7-151-10

Gouges

20 cm 10mm , 20 cm 15mm , 20 cm 20mm , 20
cm 25mm



Lambotte, Mini

PSI-7-152-02

Osteotome

12.5 cm 2mm , 12.5 cm 3mm , 12.5 cm 4mm ,
12.5 cm 6mm



Lambotte

PSI-7-153-15

Osteotome

24 cm 15mm , 24 cm 20mm , 24 cm 25mm , 24
cm 30mm



Lambotte

PSI-7-154-15

Osteotome

24 cm 15mm , 24 cm 20mm , 24 cm 25mm , 24
cm 30mm



Smith-Petersen

PSI-7-155-06

Osteotome

20.5 cm 6mm , 20.5 cm 9mm , 20.5 cm 13mm



Smith-Petersen

PSI-7-156-06

Osteotome

20.5 cm 6mm , 20.5 cm 9mm , 20.5 cm 13mm ,
20.5 cm 16mm , 20.5 cm 19mm



Smith-Petersen

PSI-7-157-09

Gouge

20.5 cm 9mm , 20.5 cm 14mm , 20.5 cm 19mm ,
20.5 cm 25mm



Smith-Petersen

PSI-7-158-09

Gouge

20.5 cm 9mm , 20.5 cm 14mm , 20.5 cm 19mm



Hoke

PSI-7-159-03

Osteotome

17 cm 3mm , 17 cm 5mm , 17 cm 6mm , 17 cm 8mm

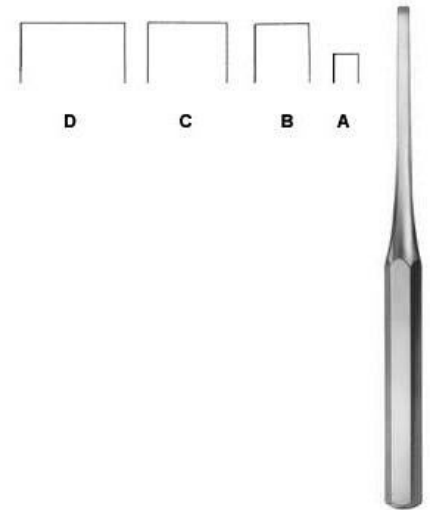

Hibbs

PSI-7-151-10

Osteotome

24.5 cm 6mm , 24.5 cm 13mm , 24.5 cm 19mm

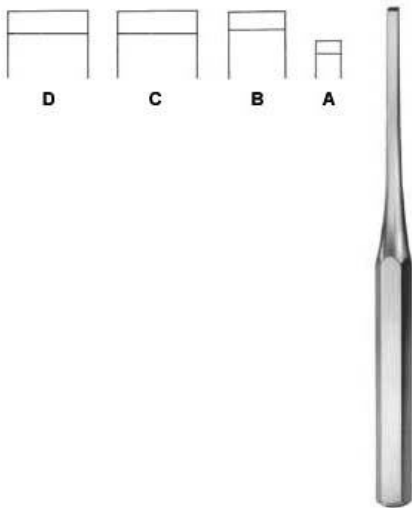

Hibbs

PSI-7-161-06

Chisel

24.5 cm 6mm , 24.5 cm 13mm , 24.5 cm 19mm

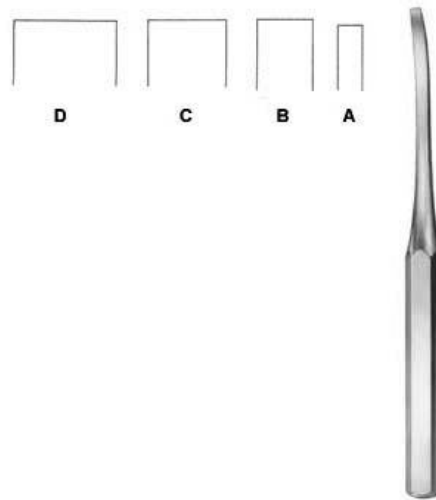

Hibbs

PSI-7-162-06

Osteotome

24.5 cm 6mm , 24.5 cm 13mm , 24.5 cm 19mm

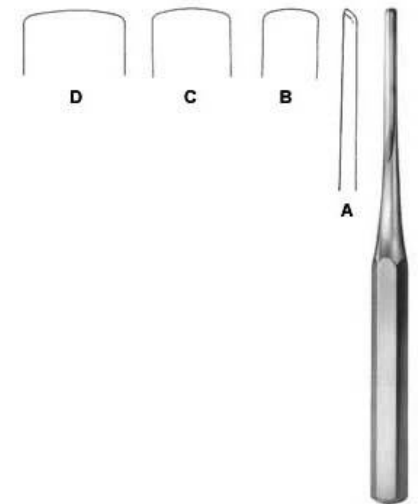

Hibbs

PSI-7-163-06

Hibbs

24.5 cm 6mm , 24.5 cm 13mm , 24.5 cm 19mm



Hibbs

PSI-7-164-06

Gouge

24.5 cm 6mm , 24.5 cm 13mm , 24.5 cm 19mm

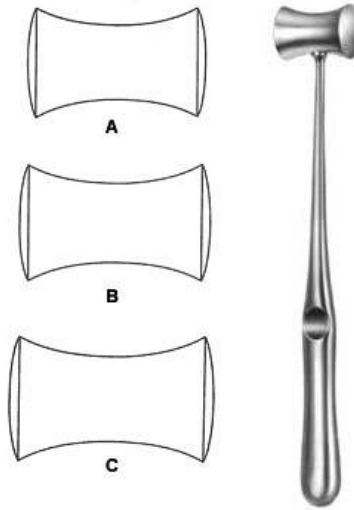

Williger

PSI-7-165-01

Mallet

24 cm

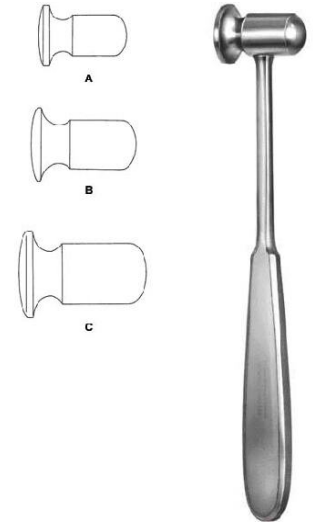

Doyen

PSI-7-166-01

Mallet

20.5 cm, 21 cm, 21.5 cm



Collin

PSI-7-151-10

Mallet

20 cm

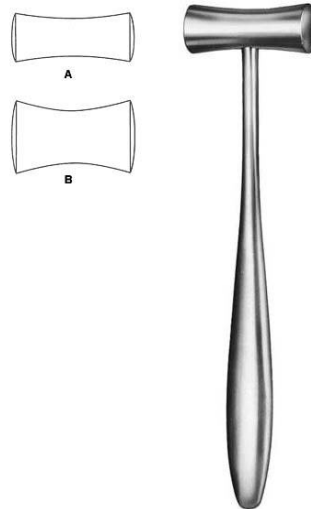

Lucae

PSI-7-168-01

Mallet

19.5 cm



Cottle

PSI-7-169-19

Mallet

19 cm



Williger

PSI-7-170-01

Mallet

16.5 cm



Mead

PSI-7-171-17

Mallet

19 cm



Partsch

PSI-7-172-18

Mallet

19 cm

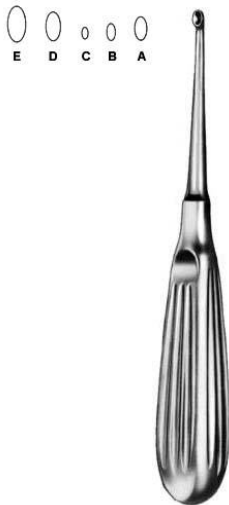

Schede

PSI-7-173-01

Bone Curette Fig. 0 to 4

17 cm



Kahre-Williger

PSI-7-201-04

Periosteal Elevator

4 mm, 5 mm, 7 mm



Periosteal Elevator

PSI-7-202-06

Periosteal Elevator

17 cm 6mm , 17 cm 8mm



Volkman

PSI-7-174-01

Bone Curette

17 cm Fig. 0, 17 cm Fig. 00, 17 cm Fig. 000, 17 cm Fig. 1, 17 cm Fig. 2, 17.5 cm Fig. 3, 17.5 cm Fig. 4



Doyen

PSI-7-203-17

Rib Raspatory

17.5 cm

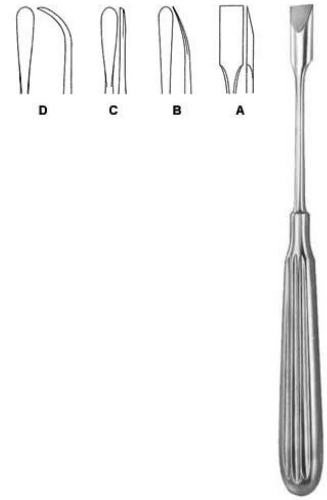

West

PSI-7-204-19

Periosteal Elevator, double-ended

17 cm, 17.5 cm

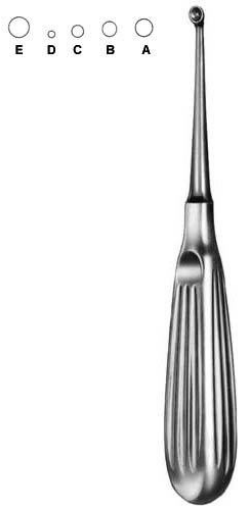

Bruns

PSI-7-175-01

Bone Curette

17 cm Fig. 0, 17 cm Fig. 00, 17 cm Fig. 000, 17 cm Fig. 1, 17 cm Fig. 2, 17 cm Fig. 3, 17 cm Fig. 4

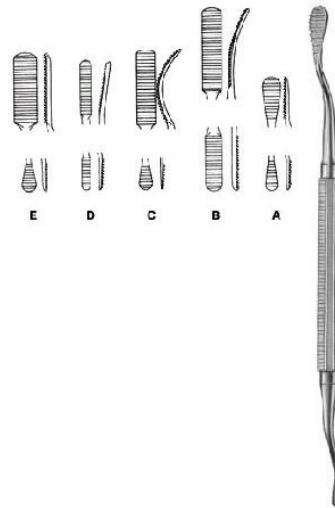

Miller-Colburn

PSI-7-209-01

Bone File

18 cm Fig. 1, 18 cm Fig. 2, 18 cm Fig. 3, 18 cm Fig. 4, 18 cm Fig. 5



Spratt

PSI-7-175-01

Bone Curette

17 cm Fig. 0, 17 cm Fig. 00, 17 cm Fig. 000, 17 cm Fig. 0000, 17 cm Fig. 1, 17 cm Fig. 2, 17 cm Fig. 3, 17 cm Fig. 4, 17 cm Fig. 5

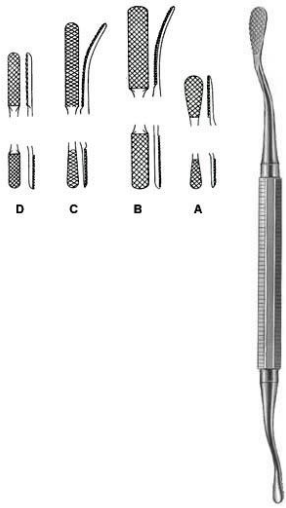

Miller-Colburn

PSI-7-210-01

Bone File

18 cm Fig. 1, 18 cm Fig. 2, 18 cm Fig. 3, 18 cm Fig. 4



Langenbeck

PSI-7-211-20

Elevator



Bruns

PSI-7-177-01

Bone Curette

23 cm Fig. 0, 23 cm Fig. 00, 23 cm Fig. 000, 23 cm Fig. 1, 23 cm Fig. 2, 23 cm Fig. 3

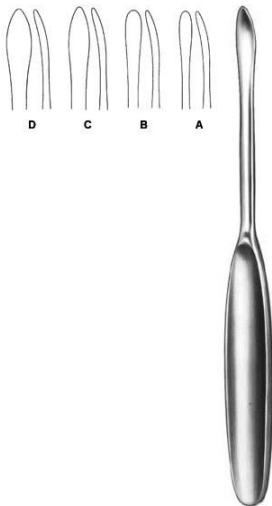

Martin-Langenbeck

PSI-7-212-01

Elevator

17 cm 5mm, 17 cm 7mm, 17 cm 8mm



Scoville

PSI-7-178-25

Bone Curette

25 cm



Vickers

PSI-7-213-17

Elevator

17 cm



Vickers

PSI-7-214-17

Dissector
17 cm

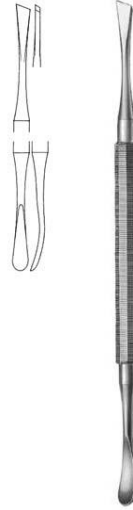

Simon

PSI-7-179-01

Bone Curette
25 cm Fig. 1, 25 cm Fig. 2, 25 cm Fig. 3, 25 cm Fig. 4, 25 cm Fig. 5



Williger

PSI-7-215-17

Elevator
16.5 cm 5.5mm



Modell USA

PSI-7-180-01

Bone Curette
16 cm Fig. 1, 16 cm Fig. 2, 16 cm Fig. 3, 16 cm Fig. 4



Williger

PSI-7-216-16

Elevator
16.5 cm 5.5mm



Mead

PSI-7-217-17

Mallet
19 cm



Periosteal Elevator

PSI-7-218-18

Periosteal Elevator



Hohmann

PSI-7-219-43

Bone Lever
23.5 cm



Modell USA

PSI-7-181-01

Bone Curette
15.5 cm Fig. 1 , 15.5 cm Fig. 2 , 15.5 cm Fig. 3 ,
15.5 cm Fig. 4



Lempert

PSI-7-220-19

Bone Rongeur
19 cm



Modell USA

PSI-7-182-01

Bone Curette
15.5 cm Fig. 1 , 15.5 cm Fig. 2 , 15.5 cm Fig. 3 ,
15.5 cm Fig. 4

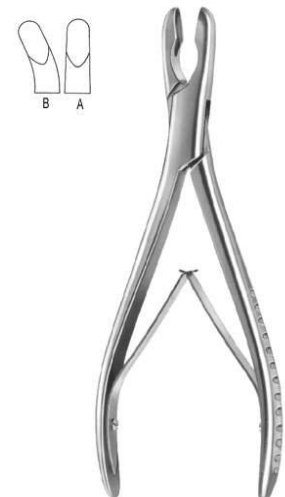

Luer

PSI-7-221-17

Bone Rongeur
18 cm, 18.5 cm



Zaufal-Jansen

PSI-7-222-18

Bone Rodent
18 cm



Hall

PSI-7-183-01

Bone Curette
21 cm Fig. 1. 21 cm Fig. 2. 21 cm Fig. 3



Demel

PSI-7-124-01

Wire Guide
31 cm Fig. 1



Volkman

PSI-7-184-01

Bone Curette, double-ended
12.5cm, 14.5cm, 17cm



Volkman

PSI-7-185-13

Bone Curette, double-ended
13 cm, 16 cm



Bone Curette

PSI-7-186-21

Bone Curette, double-ended
21 cm



Williger

PSI-7-187-00

Bone Curette, double-ended

13.5 cm Fig. 00/0 , 13.5 cm Fig. 0/1 , 13.5 cm Fig. 1/2

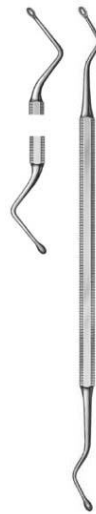

Hemingway

PSI-7-189-11

Bone Curette, double-ended

18 cm



Hemingway

PSI-7-190-00

Bone Curette, double-ended

18.5 cm



Bone Curette

PSI-7-191-01

Bone Curette, double-ended

17.5 cm

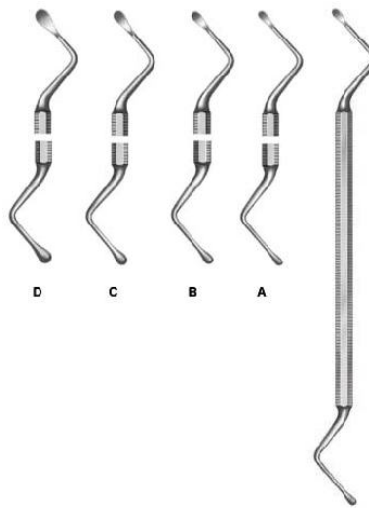

Lucas

PSI-7-192-11

Bone Curette, double-ended

18 cm

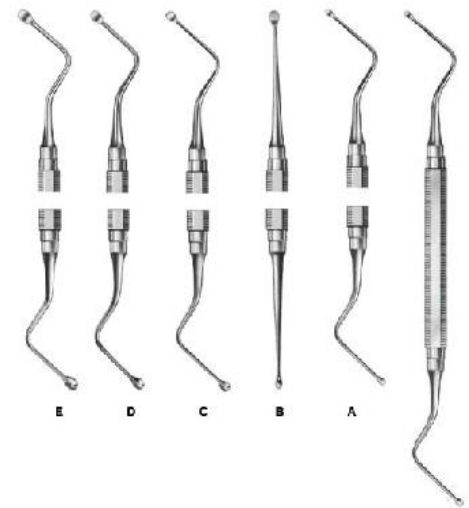

Miller-Colburn

PSI-7-193-00

Bone Curette, double-ended

17 cm Fig. 0, 17 cm Fig. 1 , 17 cm Fig. 2 , 17 cm Fig. 3

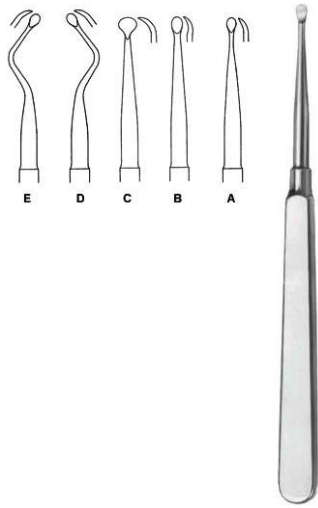

Molt

PSI 7-194-01

Bone Curette

17 cm FIG. 1, 17 cm FIG. 2, 17 cm FIG. 3, 17 cm FIG. 4

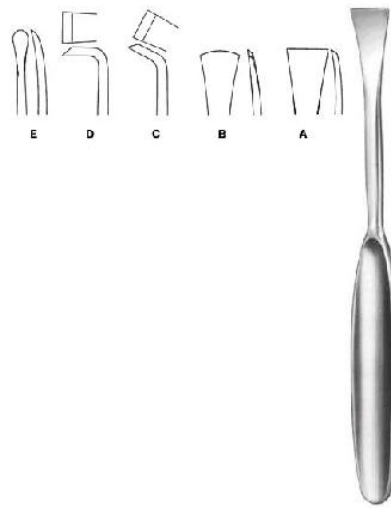

Martin-Langenbeck

PSI 7-195-01

Periosteal Elevator

19 cm 16mm



Langenbeck

PSI 7-196-18

Periosteal Elevator

18.5 cm



Langenbeck

PSI 7-197-19

Periosteal Elevator

19.5 cm



Periosteal Elevator

PSI 7-198-05

Periosteal Elevator

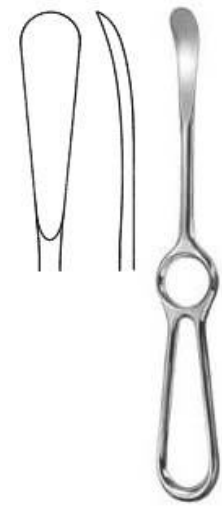

Sédillot

PSI 7-199-21

Periosteal Elevator

22 cm 15mm



Williger

PSI-7-200-13

Periosteal Elevator
12.5 cm 5mm



Kahre-Williger

PSI-7-201-04

Periosteal Elevator
4 mm, 5 mm, 7 mm

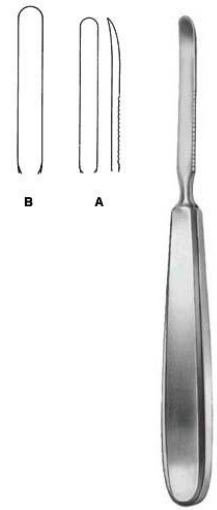

Periosteal Elevato

PSI-7-202-06

Periosteal Elevato
17 cm 6mm , 17 cm 8mm



Doyen

PSI-7-203-17

Rib Raspatory
17.5 cm

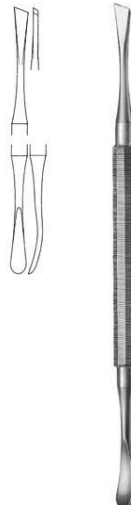

West

PSI-7-204-19

Periosteal Elevator, double-ended
18.5 cm

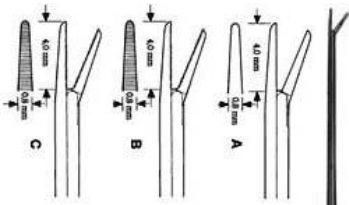

ENT

PSI-12-101-01

Micro Ear Forceps shaft length 80mm, smooth straight, serrated straight

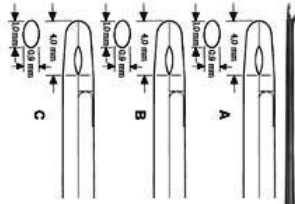

ENT

PSI-12-102-01

Micro Ear Forceps shaft lengths 80mm, straight, bent upwards

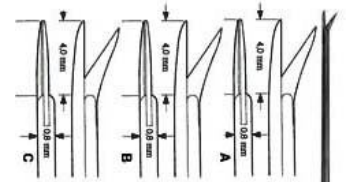

Bellucci

PSI-12-103-01

Micro Ear Scissors shaft length 80 mm



McGee

PSI-12-104-11

Wire Bending Forceps Wire Bending Forceps shaft length 80 mm

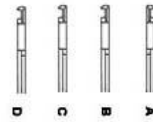

House-Dieter

PSI-12-105-01

Malleus Nipper shaft length 80 mm



Fuller

PSI-12-106-01

Introducing Forceps shaft length 80 mm



Schuknecht

PSI-12-107-02

Rotary Knife

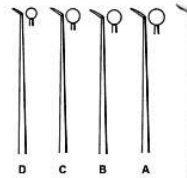

Rosen

PSI-12-108-01

Circular Cut Knife

15 cm Fig. 1 3mm?, 15 cm Fig. 2 2,8mm?, 15 cm Fig. 4 2mm?, 15 cm Fig. 5 1,6mm?, 15 cm Fig. 6 1,4mm?, 15 cm Fig. 7 1,0mm?

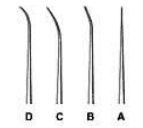

Barbara

PSI-12-109-01

Micro Ear Needle 0,3mm to 2,5mm

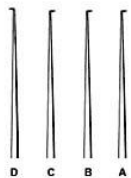

Micro Ear Hook

PSI-12-110-01

Micro Ear Hook 0,3mm to 1,0mm



Micro Ear Hook

PSI-12-111-06

Micro Ear Hook 0,3mm to 3,0mm, 25, 45, 90 degree

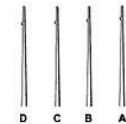

House

PSI-12-112-01

Micro Measuring Rod
15.5 cm 3,5mm, 15.5 cm 4,0mm , 15.5 cm 4,5mm,
15.5 cm 5,0mm



House
PSI-12-113-01
Micro Curette
14.5 cm



Hartmann
PSI-12-114-03
Ear Specula, Set
3.6 cm Fig. 0, 3.6 cm Fig. 1, 3.6 cm Fig. 2, 3.6 cm Fig. 3, 3.6 cm Fig. 4



Zollner
PSI-12-115-00
Ear Specula, Set
3.8 cm



Farrior
PSI-12-116-01
Ear Speculum
3.8 cm



Martin-Alloy
PSI-12-117-12
Tuning Fork
c2 512



Hartmann
PSI-12-118-10
Tuning Fork
c 128



Lucae
PSI-12-119-10
Tuning Fork
c 128



Hartmann
PSI-12-120-10
Tuning Fork



Hartmann
PSI-12-121-11
Tuning Fork

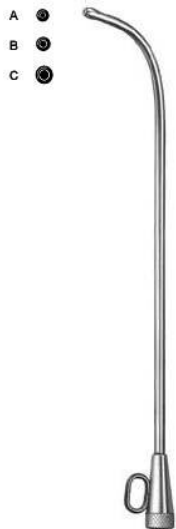

Hartmann
PSI-12-122-01
Ear Catheter
15 cm



Troeltsch (Wilde)
PSI-12-123-11
Ear Forceps
10.5 cm



Troeltsch (Wilde)
PSI-12-124-12
Ear Forceps
11



Troeltsch (Wilde)

PSI-12-125-13

Ear Forceps
12.5 cm



Grunwald

PSI-12-126-14

Ear Forceps
14.5 cm



Jansen

PSI-12-127-16

Ear Forceps

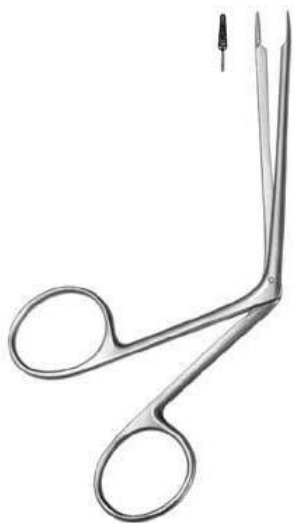

Littauer

PSI-12-128-12

Ear Polypus Forceps
10 cm



Hartmann

PSI-12-129-12

Ear Polypus Forceps
12 cm



Hartmann

PSI-12-130-14

Ear Polypus Forceps
12 cm



Hartmann-Wullstein

PSI-12-131-08

Ear Polypus Forceps shaft length 85mm



Citelli

PSI-12-132-17

Mastoid Rongeur 3mm cut



Beyer

PSI-12-133-19

Mastoid Rongeur 2mm cut



Beyer

PSI-12-134-14

Mastoid Rongeur 1mm cut



Langenbeck

PSI-12-135-13

Ear Curette



Shapleigh

PSI-12-136-01

Ear Curette
15 cm



Buck
PSI-12-137-02
Ear Curette
17 cm



Jansen
PSI-12-138-15
Ear Scoop
17 cm



Gross
PSI-12-139-12
Ear Scoop/Hook



Weber-Loch
PSI-12-140-01
Foreign Body Instrument
16.5 cm



Billeau
PSI-12-141-01
Ear Loop



Zaufal
PSI-12-142-16
Foreign Body Lever
15 cm



Wagener
PSI-12-143-01
Ear Hooklet



Day
PSI-12-144-01
Ear Hooklet
17 cm



Poltzer
PSI-12-145-16
Tympanum Needle



Lucae
PSI-12-146-18
Tympanum Needle
17.5 cm



Lempert
PSI-12-147-20
Micro Ear Periosteal Elevator
20.5 cm



Lempert
PSI-12-148-17
Micro Ear Periosteal Elevator
18 cm

00000
EDCBA



Lempert

PSI-12-149-10

Ear Scoop



Ear Syringe

PSI-12-150-00

Ear Syringe



Goldsmith (Thudichum)

PSI-13-101-01

Nasal Speculum

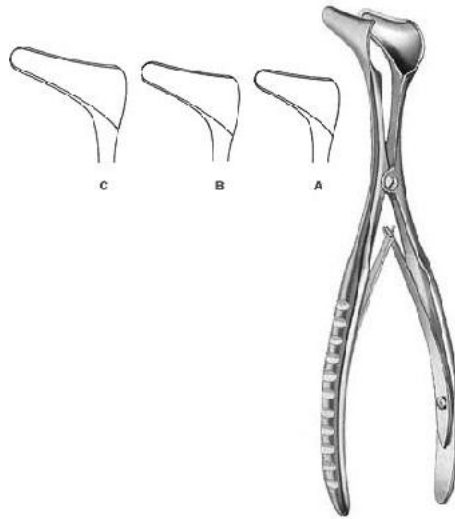

Hartmann-Halle

PSI-13-102-01

Nasal Speculum



Martin

PSI-13-103-13

Nasal Speculum



Martin

PSI-13-104-13

Nasal Speculum

12.5 cm



Tieck-Halle

PSI-13-105-13

Nasal Speculum

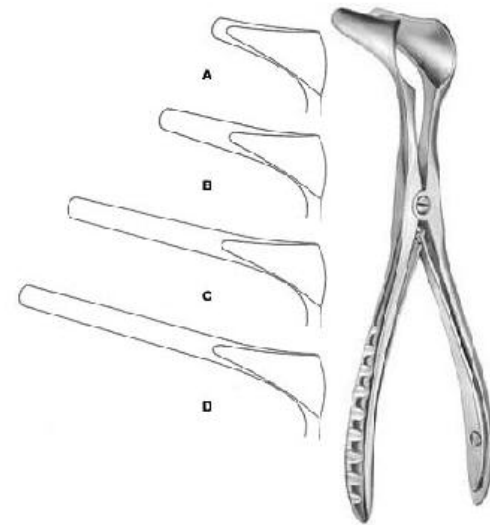

Killian

PSI-13-106-01

Nasal Speculum

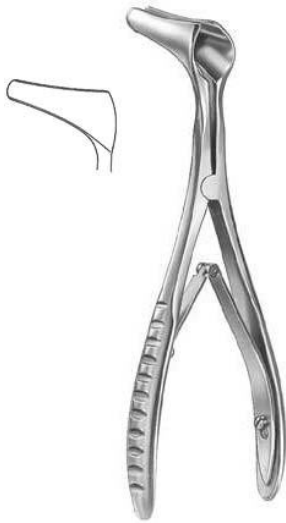

Modell Wien

PSI-13-107-14

Nasal Speculum

13.5 cm

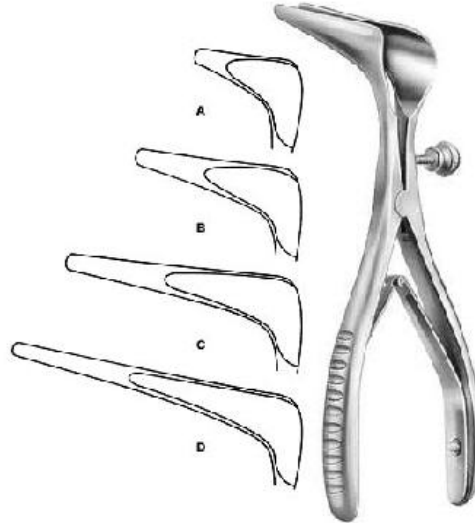

Cottle

PSI-13-108-35

Nasal Speculum

13.5 cm , 14.5 cm



Cottle

PSI-13-109-45

13.5 cm



Cottle

PSI-13-110-15

Nasal Tampon Forceps

14.5 cm



Troeltsch

PSI-13-111-18

Nasal Tampon Forceps

18 cm



Grunwald (Jansen)

PSI-13-112-20

Nasal Tampon Forceps



Lubet-Barbon

PSI-13-113-20

Nasal Tampon Forceps
18.5 cm



Lubet-Barbon

PSI-13-114-20

Nasal Tampon Forceps
18.5 cm



Killian

PSI-13-115-16

Septum Forceps



Takahashi

PSI-13-116-12

Ethmoid Bone Forceps
1 - 119x20

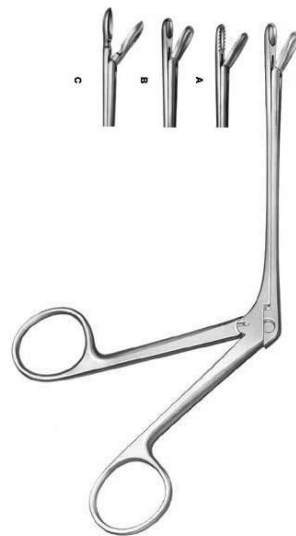

Watson-Williams

PSI-13-117-10

Ethmoid Bone Forceps
1 - 119x20

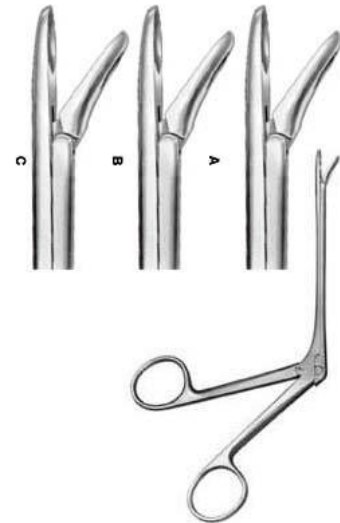

Weil-Blakesley

PSI-13-118-01

Nasal Cutting Forceps
12 cm

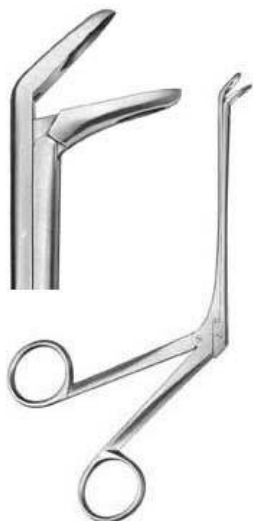

Weil-Blakesley

PSI-13-119-01

Ethmoid Bone Forceps shaft length 120mm

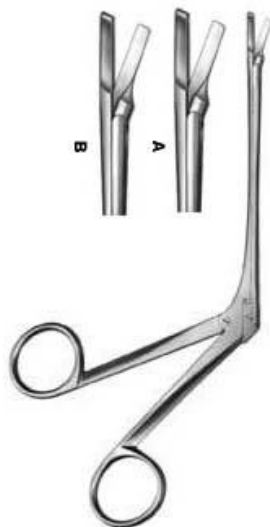

Struycken

PSI-13-120-01

Nasal Cutting Forceps

1 - 119x20



Hartmann

PSI-13-121-01

Nasal Cutting Forceps

1 - 119x20



Schmeden

PSI-13-122-12

Nasal Cutting Forceps

1 - 119x20



Ferris-Smith-Kerrison

PSI-13-123-17

Sphenoid Bone Punch

18 cm

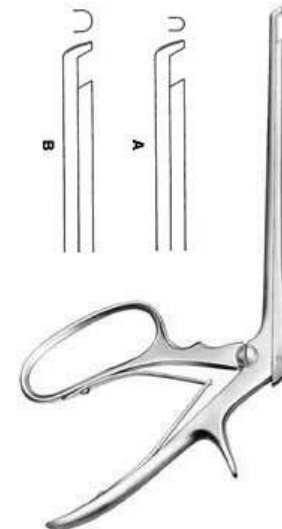

Ferris-Smith-Kerrison

PSI-13-124-03

Sphenoid Bone Punch

18 cm



Kerrison
PSI-13-125-00
Antrum Punch

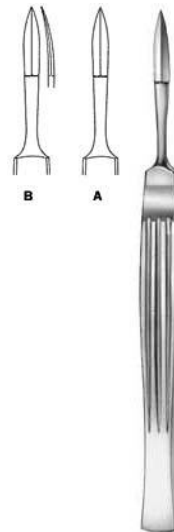

Joseph
PSI-13-126-01
Rhinoplastic Knife
15 cm



Fomon
PSI-13-127-16
Rhinoplastic Knife
16.5 cm



Converse
PSI-13-128-16
Rhinoplastic Knife



Cottle
PSI-13-129-15
Rhinoplastic Knife
14 cm



Freer
PSI-13-130-15
Mucosa Knife
16.5 cm



McKenty

PSI-13-131-04

Septum Elevator
15 cm



Halle

PSI-13-132-16

Septum Elevator



Joseph

PSI-13-133-16

Septum Elevator



Freer

PSI-13-134-20

Septum Elevator
1 - 119x20

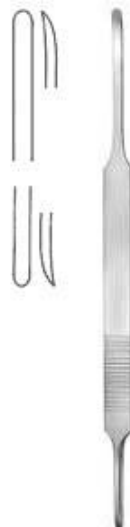

McKenty

PSI-13-135-22

Septum Elevator
20.5 cm



Ballenger-Hajek

PSI-13-136-19

Septum Elevator
1 - 119x20



Cottle

PSI-13-137-22

Septum Elevator

23 cm

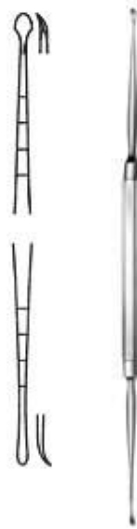

Masing

PSI-13-138-21

Periosteal Elevator

1 - 119x20

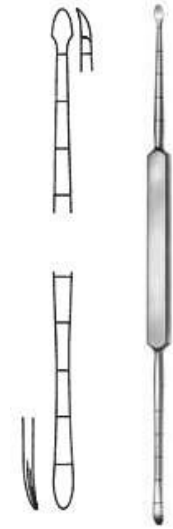

Cottle

PSI-13-139-21

Periosteal Elevator



Joseph

PSI-13-140-16

Periosteal Elevator



Freer

PSI-13-141-15

Septum Gouge

15 cm



Killian

PSI-13-142-16

Septum Gouge



Killian-Claus
PSI-13-143-16
Septum Gouge



Cottle
PSI-13-144-04
Osteotome
18.5 cm



Cottle
PSI-13-145-06
Osteotome
18.5 cm



Cottle
PSI-13-146-16
Osteotome
18.5 cm



Walter
PSI-13-147-03
Gouge
1 - 119x20



Fomon
PSI-13-148-04
Chisel

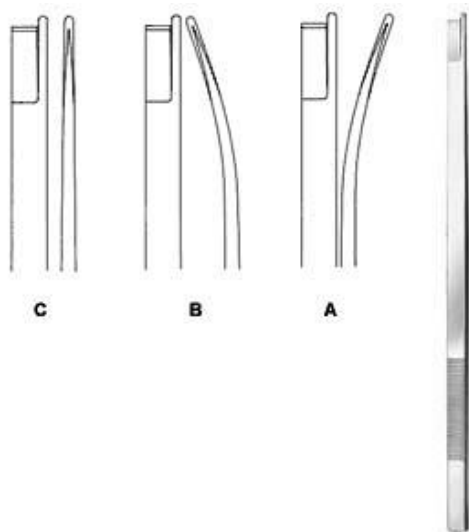

Neivert-Anderson

PSI-13-149-01

Osteotome
20.5 cm

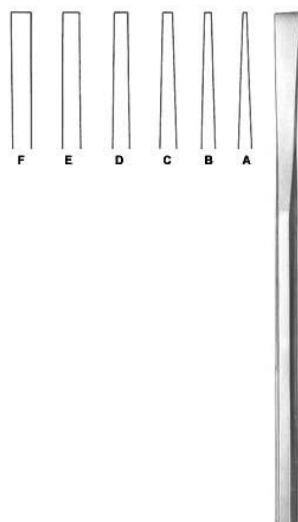

Sheehan

PSI-13-150-01

Osteotome
15 cm

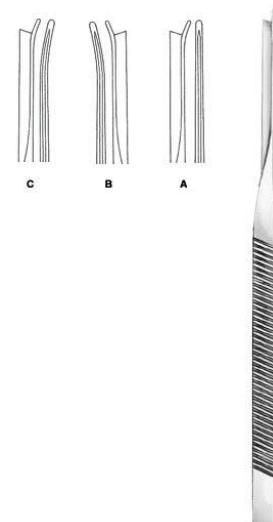

Silver

PSI-13-151-01

Rhinoplastic Chisel



Parkes

PSI-13-152-01

Osteotome

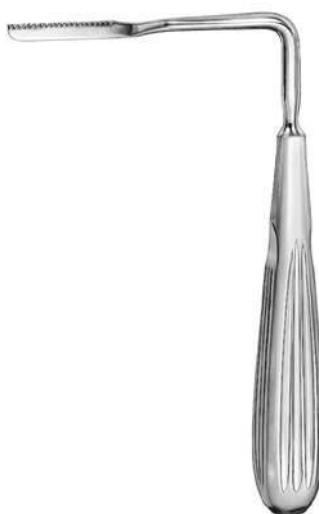

Joseph

PSI-13-153-20

Nasal Saw
17 cm

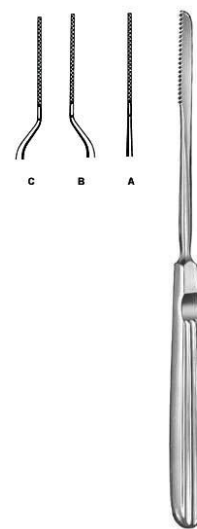

Joseph

PSI-13-154-00

Nasal Saw
1 - 119x20



Maltz
PSI-13-155-18
Nasal Rasp
17.5 cm

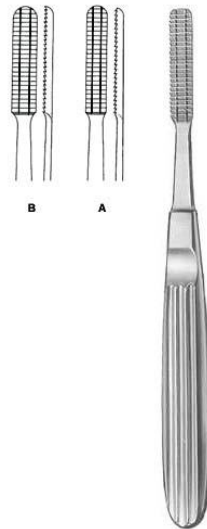

Maltz
PSI-13-156-01
Nasal Rasp
17 cm

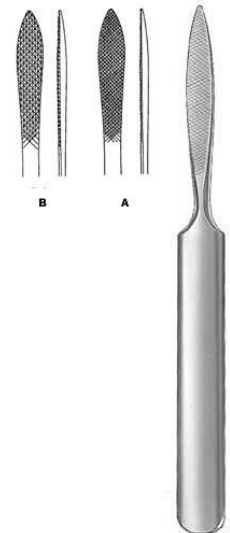

Joseph
PSI-13-157-01
Bone File



Cottle
PSI-13-158-21
Nasal Rasp
20.5 cm

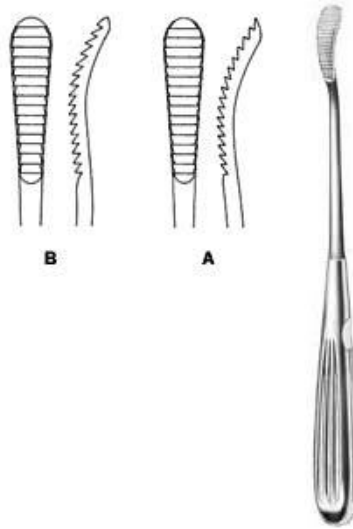

Aufrecht
PSI-13-159-21
Glabella Rasp

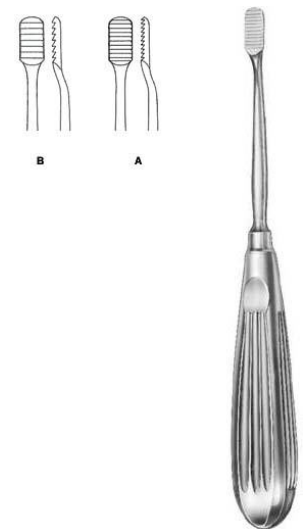

Lewis
PSI-13-160-18
Nasal Rasp
1 - 119x20



Lewis
PSI-13-161-18
Nasal Rasp
1 - 119x20

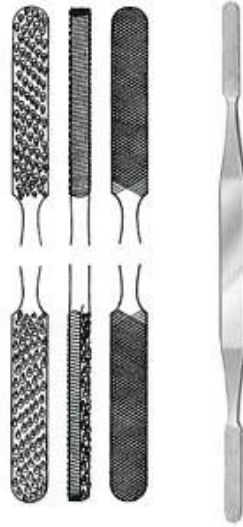

Fomon
PSI-13-162-01
Bone File
20.5 cm



Cottle
PSI-13-163-01
Nasal Hook
17 cm



Converse
PSI-13-164-01
Nasal Retractor



Converse
PSI-13-165-12
Alar Hooklet



Freer
PSI-13-166-15
Mucosa Hooklet
15 cm



Joseph
PSI-13-167-02
Mucosa Hooklet
16.5 cm



Cottle-Neivert
PSI-13-168-20
Alar Hooklet
19.5 cm



Cottle
PSI-13-169-15
Saddle Hook
14 cm



Kressner
PSI-13-170-20
Septum Forceps

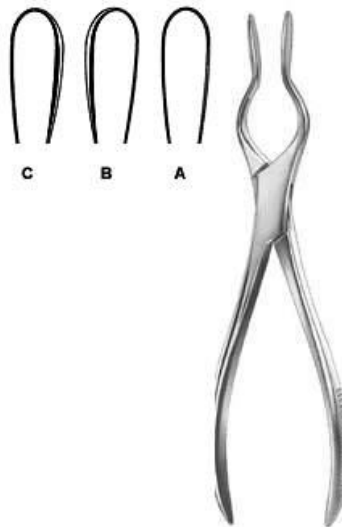

Cottle-Walsham
PSI-13-171-01
Septum Straightening Forceps
23 cm

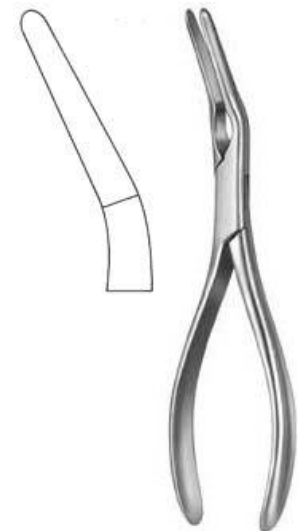

Asch
PSI-13-172-23
Septum Straightening Forceps
22.5 cm



Ogura

PSI-13-13-11

Skin Grasping Forceps

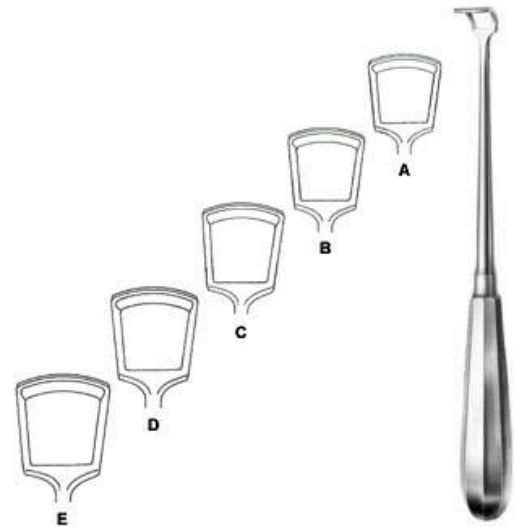

Beckmann

PSI-13-174-01

Adenoid Curette
22.5 cm

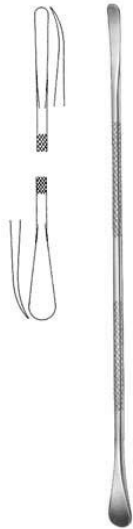

Terry
PSI-14-101-16
Elevator
17 cm



Terry
PSI-14-102-00
Periosteal Elevator

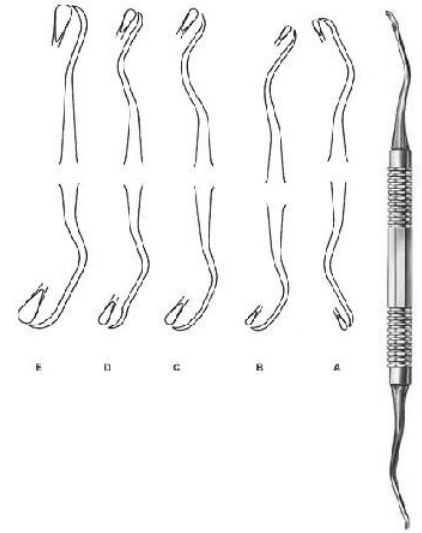

Sinus Lift Curette
PSI-14-103-01
Sinus Lift Curette
17.5 cm, 18.5 cm, 1 - 119x20, 15 cm, 17 cm



Heister
PSI-14-104-13
Mouth Gag



Molt
PSI-14-105-11
Mouth Gag



Denhart
PSI-14-106-12
Mouth Gag

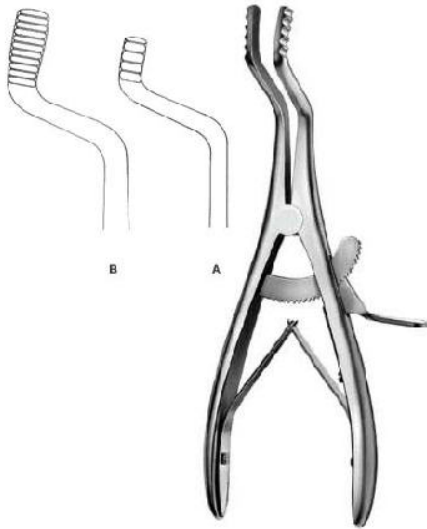

Roser-Konig

PSI-14-107-16

Mouth Gag

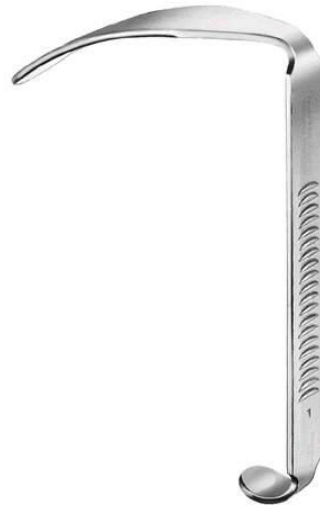

Roser-Knig

PSI-14-108-16

Mouth Gag
13.5 cm



Jennings

PSI-14-109-09

Mouth Gag
10.5 cm



Oringer

PSI-14-110-00

Lip and Cheek Retractor
10.5 cm , 10



Martin-Simplex

PSI-14-111-11

Cheek Retractor
10.5 cm



Vestibulum Retractor

PSI-14-112-14

Vestibulum Retractor
14 cm



Sternberg

PSI-14-113-14

Lip and Cheek Retractor

14 cm



Obwegeser

PSI-14-114-12

Cheek Retractor

12 cm



Cawood-Minnesota

PSI-14-115-15

Cheek Retractor

15 cm



Cheek Retractor

PSI-14-116-00

Cheek Retractor

14 cm



Hartmann

PSI-14-117-15

Tongue Depressor

15 cm



Tobold

PSI-14-118-14

Tongue Depressor

15 cm



Tobold
PSI-14-119-14
Tongue Depressor
14.5 cm



Tongue Spatula
PSI-14-120-16
Tongue Spatula



Tongue Spatula
PSI-14-121-15
Tongue Spatula
15 cm



Martin
PSI-14-122-18
Tongue Spatula
18.5 cm



Doyen
PSI-14-123-18
Tongue Spatula
13.5 cm



Bruennings
PSI-14-124-19
Tongue Spatula
1 - 119x20



Collin

PSI-14-125-17

Tongue Holding Forceps
17 cm



Young

PSI-14-126-17

Tongue Holding Forceps
15 cm



Obwegeser

PSI-14-127-40

Soft Tissue Retractor



Obwegeser

PSI-14-128-22

Nasal Spine Retractor



Obwegeser

PSI-14-129-22

Ramus Retractor



Obwegeser

PSI-14-130-16

Chin Retractor
16.5 cm



Obwegeser

PSI-14-131-18

Channel Retractor

17 cm



Retractor

PSI-14-132-01

Retractor

18.5 cm



Periosteal Elevator

PSI-14-133-01

Periosteal Elevator



Obwegeser

PSI-14-134-06

Periosteal Elevator

17.5 cm



Obwegeser

PSI-14-135-21

Elevator

20.5 cm



Gillies

PSI-14-136-21

Zygoma Elevator



Obwegeser

PSI-14-137-21

Elevator
20.5 cm



Rowe

PSI-14-138-01

Disimpaction Forceps
22.5 cm



Rowe

PSI-14-139-01

Disimpaction Forceps
22.5 cm



Dingmann

PSI-14-140-21

Zygoma Elevator



Dingmann-Wilk

PSI-14-141-19

Retractor



Jeter-Van Sickels

PSI-14-142-01

Bone Holding Forceps



Keen

PSI-14-143-01

Bone Holding Forceps
17.5 cm



Steinhauser

PSI-14-144-01

Bone Holding Forceps



Wolford

PSI-14-145-25

Bone Holding Forceps
25 cm



Salyer

PSI-14-146-16

Bone Holding Forceps



Bauer

PSI-14-147-00

Osteotome
20.5 cm



Bauer

PSI-14-148-00

Osteotome
20.5 cm



Epker-Bauer

PSI-14-149-01

Osteotome
17.5 cm



Dautrey-Munro

PSI-14-150-04

Osteotome

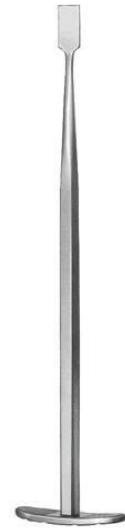

Dunn-Dautrey

PSI-14-151-04

Osteotome
16.5 cm



Dunn-Dautrey

PSI-14-152-01

Osteotome
17 cm



Epker

PSI-14-153-04

Osteotome



Hargis

PSI-14-154-19

Anterior Border Stripper
1 - 119x20



Hargis

PSI-14-155-01

Periosteal Elevator

23 cm



Hargis

PSI-14-156-18

Periform Rim Retractor

18.5 cm



Hargis

PSI-14-157-22

Pterygoid Osteotome



Smith

PSI-14-158-01

Sagittal Split Separator

17 cm



Terry

PSI-14-159-16

Mandibular Retractor

16.5 cm



Terry

PSI-14-160-24

Ramus Pusher

24 cm



Terry
PSI-14-161-00
Occlusal Wedge



Steinhauser
PSI-14-162-18
Elevator
18.5 cm



Steinhauser
PSI-14-163-07
Ramus Osteotome
17 cm



Steinhauser
PSI-14-164-07
Chisel
1 - 119x20



Steinhauser
PSI-14-165-01
Periosteal Elevator



Steinh?User
PSI-14-166-16
Steinh?user
16.5 cm



Steinhilber
PSI-14-167-05
Orbital Osteotome



Wolford
PSI-14-168-06
Osteotome
23 cm



Salyer

PSI-15-101-18

Cleft Palate Hooklet

18.5 cm



Salyer

PSI-15-102-18

Cleft Palate Hooklet

18.5 cm



Salyer

PSI-15-103-08

Cleft Palate Dissector

18.5 cm



Salyer

PSI-15-104-18

Cleft Palate Dissector



Salyer

PSI-15-105-18

Cleft Palate Elevator



Salyer

PSI-15-106-18

Cleft Palate Elevator



Salyer

PSI-15-107-18

Cleft Palate Elevator



JABOMA

PSI-15-108-17

Cleft Palate Periosteal Elevator

17 cm



Hurd

PSI-15-109-21

Cleft Palate Needle

20.5 cm



Hurd

PSI-15-111-21

Cleft Palate Needle

20.5 cm

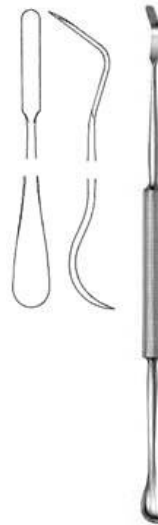

Carpenter

PSI-15-112-25

Tonsil Knife / Enucleator

25 cm



Hurd

PSI-15-113-22

Tonsil Dissector/Retractor

22.5 cm

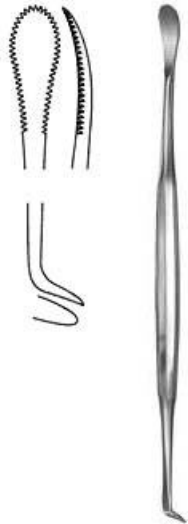

Henke
PSI-15-114-23
Tonsil Elevator
22.5 cm

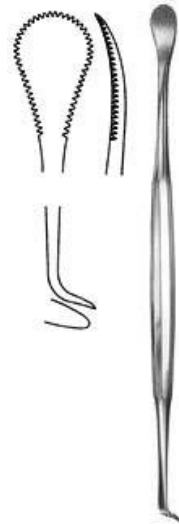

Henke
PSI-15-115-23
Tonsil Elevator
22.5 cm

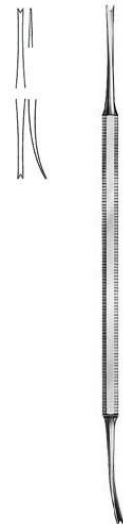

Luniatschek
PSI-15-116-19
Gauze Packer
17.5 cm



Luniatschek
PSI-15-116-19
Gauze Packer
17.5 cm



White
PSI-15-118-18
Tonsil Grasping Forceps



Blohmke
PSI-15-119-20
Tonsil Grasping Forceps

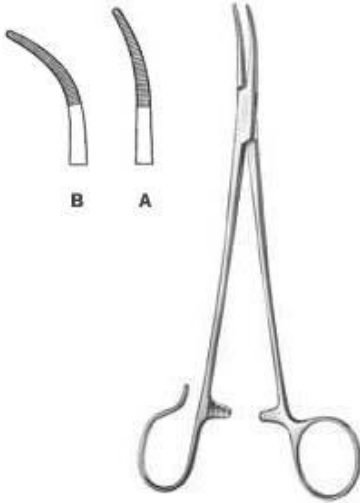

Schnidt

PSI-15-120-19

Tonsil Forceps
1 - 119x20

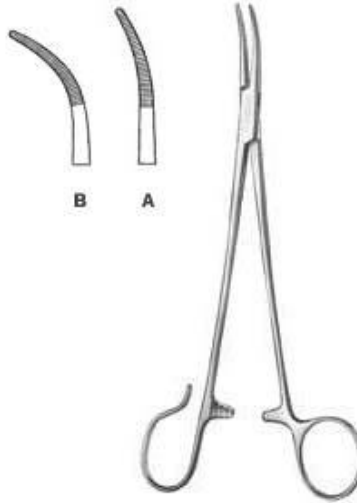

Schnidt

PSI-15-121-19

Tonsil Forceps
1 - 119x20, 18.5 cm



Eves

PSI-15-122-28

Tonsil Snare



Eves

PSI-15-123-28

Tonsil Snare

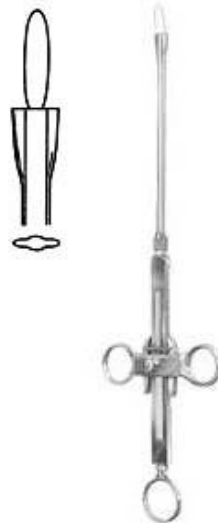

Brunings

PSI-15-124-28

Tonsil Snare

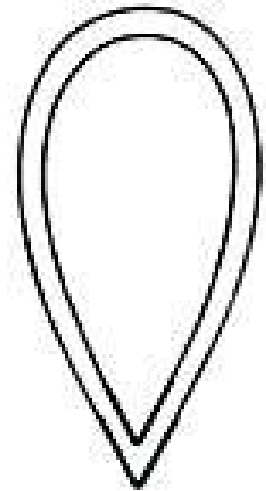

Wire Loop

PSI-15-125-40



Snare Wire
PSI-15-126-01

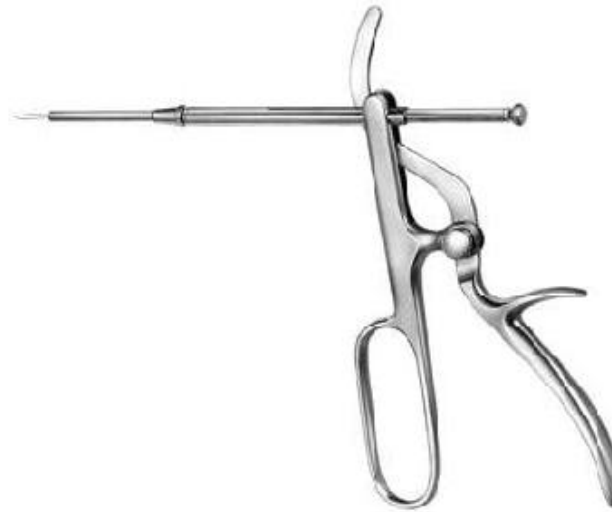

Tyding
PSI-15-127-01
Tonsil Snare



Hartmann
PSI-15-128-13
Tonsil Punch
12 cm



Huber
PSI-15-129-01
Universal Handle
30 cm



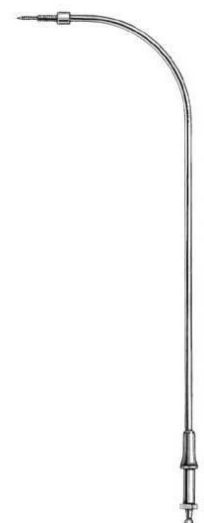

Bruenings
PSI-15-130-20
Interchangeable Tube





Bruenings
PSI-15-131-20
Laryngeal Tube

Contact Us For Superior Service

 Airport Road, Opposite. PSO Petrol Pump, 51340, Sialkot-Pakistan.

 +92 52 4263703

 +92 52 4291383

 info@psislk.com

 +92 333 8566685

 Laryngoscope2



CONTACT US